

DECEMBER 8, 1977

TESTING PROBLEMS PLAGUE LSI CHIP USERS AND VENDORS/65

Memories, power devices stand out at Electron Devices meeting/ 109

Fluorescence brightens liquid-crystal displays/ 113

FOUR DOLLARS A MCGRAW-HILL PUBLICATION

Electronics®

OVER THE DESIGN SPECTRUM

**A WEALTH OF
MICROCOMPUTERS**

FIRST OF A TWO-PART SERIES



Introducing HP's 3438A system DMM...

The right DMM decision for low-cost data acquisition

If you're looking for low-cost data acquisition using the HP-IB* here's a new DMM alternative... HP's new 3438A. It's the first 3½ digit DMM that's HP-IB compatible. And it's priced at just \$875**.

Simple or complex. Use the 3438A in simple data gathering applications with HP's 5150A low-cost printer. Or for automatic data acquisition and analysis, use your 3438A with an HP 9815A or 9825A computing controller and 3495A scanner. Of course the HP-IB interconnect system solves your interface problems and makes system integration as simple as plugging in interconnecting cables.

Autorangeing. The 3438A automatically selects the proper range on AC or DC volts and ohms eliminating the need for range programming. Any one of the five DMM functions is conveniently selected on the front panel.

High sensitivity. Sensitivities of 10 milliohms, 100 μ V and 100 nA allow you to monitor low-level transducer signals directly. And long-term stability assures accurate readings over long periods of unattended operation.

Wide AC bandwidth. Measure AC voltages from 30Hz up to 100 kHz with midband accuracy of 0.3% of reading plus three digits. DC voltages up to 1200 V are measured with a full-year best accuracy figure of 0.1% of reading plus one digit.

Self test modes. Internal circuitry checks for proper DMM operation by quickly verifying proper conversion and data transfer. Should troubleshooting be required, the 3438A is designed to use HP's 5004A Logic Signature Analyzer for rapid problem isolation.

Rugged and versatile. Using the latest in LSI technology and packaged in HP's System II rackmount configuration, the 3438A adapts to a variety of needs—in bench systems, existing HP-IB systems or new instrument systems. Your local HP field engineer has all the details. Contact him today.

* HP's implementation of IEEE Standard 488-1975.
** Domestic U.S.A. price only.

**HP DMM's—
the right decision**



HEWLETT  PACKARD

1507 Page Mill Road, Palo Alto, California 94304

For assistance call: Washington (301) 948-6370, Chicago (312) 255-9800, Atlanta (404) 955-1500, Los Angeles (213) 877-1282

Circle 900 on reader service card

SURPRISE!

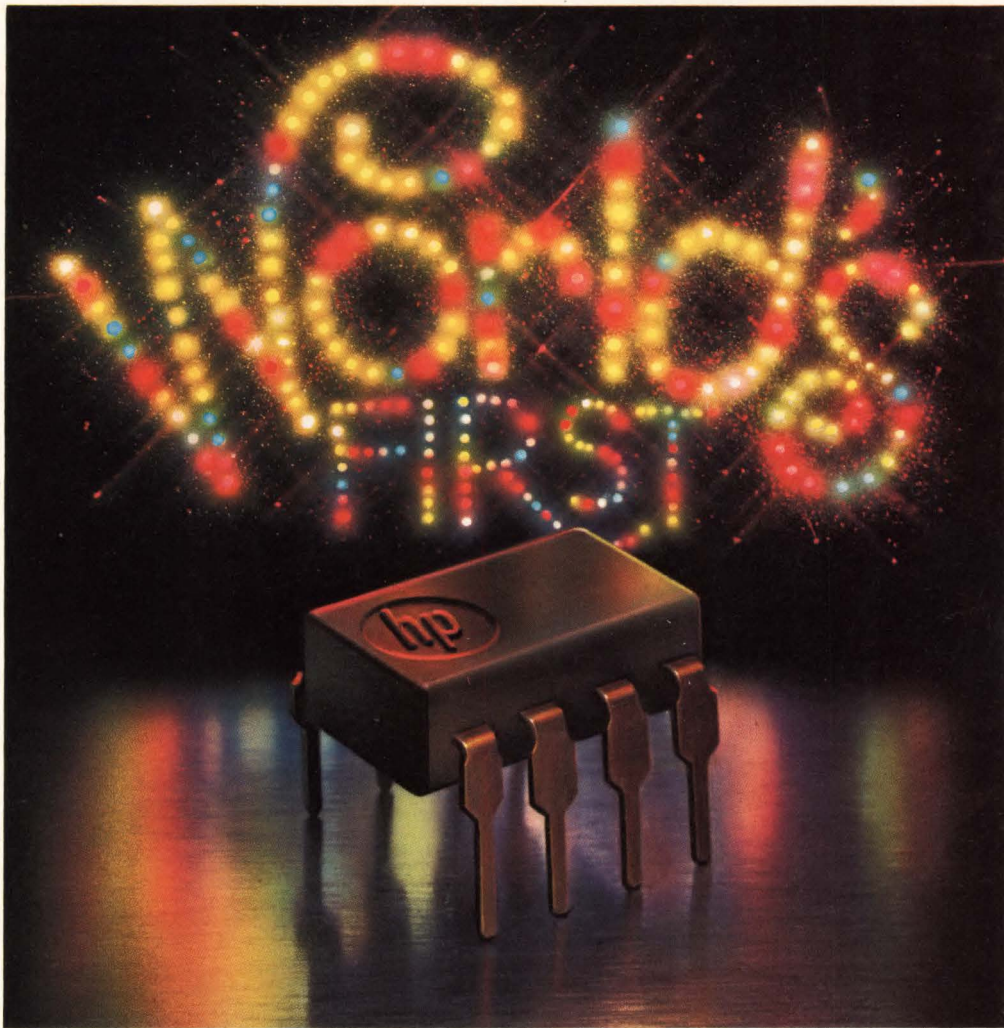

Introducing HP's New Optically Coupled Line Receiver

Eliminate troublesome system ground loops and increase long distance communication noise immunity with HP's new easy-to-use optically coupled line receiver. An internal IC regulator serves as a line termination and allows direct connection to transmission lines without any additional components.

Use of a high-speed, high-gain output photo IC permits data rates in excess of 10 Mbits/second. An internal shield provides excellent common mode rejection even at these high data rates.

The HCPL-2602 is designed for high-speed data transmission applications such as computer-peripheral interface, instrumentation, and simplex/multiplex data transmission.

Priced at \$6.65* in quantities of 1000, the HCPL-2602 is in stock at any franchised distributor. In the U.S., contact Hall-Mark, Hamilton/Avnet, Pioneer Standard, Schweber, Wilshire or the Wyle Distribution Group (Liberty-Elmar) for immediate delivery.

In Canada, just call Hamilton/Avnet or Zentronics, Ltd. *U.S. Domestic price only

HEWLETT  PACKARD

1507 Page Mill Road, Palo Alto, California 94304

Instrumentation Interfacing: how does your real-time computer measure up?

Feature	Our HP 1000 and 21MX Computers	Your old favorite
Standard Interfaces (IEEE-488, ANSI MC 1. 1)	HP-Interface Bus (HP-IB) simplifies connections to over 200 bus-compatible instruments for stimulus, measurement and display, and reduces installation costs. High-level READ and WRITE calls in FORTRAN and BASIC simplify programming.	
Intelligent Analog and Digital Subsystem	HP's 2240A microprocessor-based analog and digital subsystem off-loads CPU and simplifies programming. Handles complete real-time tasks such as time-scheduled data acquisition, scan synchronization with external events, interrupt waits, waveform sample pacing, temperature drift corrections for high accuracy.	
Real Time Software	Compatible family of memory and disc-based Real Time Executive (RTE) operating systems. Interrupt handling at 100 μ s. Real-time BASIC, ISA FORTRAN with bit-manipulation and real-time extensions.	
Computer Costs*	HP 1000 Model 20 memory-based system from \$21,000. HP 1000 Model 30 disc-based system from \$31,500. (Both include 21MX E-series CPU, 64K bytes memory, 2645A CRT with dual mini-cartridges, RTE software.)	
Interface Costs*	Plug-in measurement and control cards: 32 analog inputs, 32 digital inputs and outputs, \$2,625. 96 channels of analog and digital I/O in μ P-controlled 2240A, \$5,110. HP-IB card, \$600.	
Delivery	8 weeks ARO.	

**All prices shown are U.S. domestic list.*

When you consider the number of instruments we make, it's not surprising that we know how to get the best out of them with our computers. If you'd like to see how well our real-time computers measure up, call you local HP office listed in the White Pages. Or write to Robert Puette, Hewlett-Packard, 11000 Wolfe Road, Dept. 613, Cupertino CA 95014. And save a lot of interface.



HEWLETT  PACKARD

Circle 2 on reader service card

22706HPDS8

31 Electronics Review

MEMORY: Bubble memory chips hit 1-megabit high, 31
INSTRUMENTS: Hewlett-Packard develops probe for interface bus, 32
MEMORY: Micro-Bit still pushes that solid-state tube, 33
FILTERS: Tunable chip uses programmable charge-coupled device, 34
PHOTOVOLTAICS: Solar-cell supplier drops from ERDA competition, 36
BUSINESS: Wema's chief seeks Washington impact, 38
CONSUMER: Matsushita shows a video disk, 38
NEWS BRIEFS: 38
IEEE: Activities Board to slow professional action, 42

55 Electronics International

GREAT BRITAIN: System with 13 8080s aids phone operators, 55
FRANCE: Data-communications users want new interface standard, 56
AROUND THE WORLD: 56

65 Probing the News

INSTRUMENTATION: LSI is testing nightmare, 65
ELECTRONICS ABROAD: West German forecasts fall short, 69
A Japanese perspective on trade, 72
CONSUMER ELECTRONICS: Japanese help watch market stay calm, 78

89 Technical Articles

SPECIAL REPORT: Part 1, Microcomputer chip families expand, 89
DESIGNER'S CASEBOOK: Modulator extends If response, 100
Programming a microcomputer for d-a conversion, 101
CIRCUIT DESIGN: Calculator programs for tuned circuits, Part 2, 104
SOLID STATE: IEDM heralds breakthroughs in device technology, 109
COMPONENTS: Dim light works with fluorescence-activated LCD, 113
ENGINEER'S NOTEBOOK: Analyzer displays Karnaugh map, 118
CALCULATOR NOTES: Program finds antenna's best fire angle, 119

125 New Products

IN THE SPOTLIGHT: Power sensor handles optical jobs, 125
Analog I/O boards mate with TI 16-bit microcomputer, 128
4-MHz analog multiplier chip has internal compensation, 130
DATA HANDLING: Analog I/O boards work with M6800, 133
INSTRUMENTS: Logic analyzer has 32 channels, 140
SEMICONDUCTORS: Data-acquisition system fits on one chip, 150
MICROPROCESSORS: Chip controls display and keyboard, 158
SUBASSEMBLIES: Amplifier is built for speed, 168
INDUSTRIAL: Two-terminal IC measures temperature, 178

Departments

Publisher's letter, 4
Readers' comments, 6
News update, 8
Editorial, 12
People, 14
Meetings, 20
Electronics newsletter, 25
Washington newsletter, 47
Washington commentary, 48
International newsletter, 53
Engineer's newsletter, 122
New literature, 192

Services

Employment opportunities, 203
Reader service card, 223

Highlights

Cover: Microcomputer families thrive, 89

The dazzling array of microcomputer chips that have come available in the last 18 months presents designers with a bewildering multiplicity of choices. Hence this first part of a special report, classifying and comparing the chips.

Cover by Mark Smith.

Slow growth in West Germany, 69

The growth rate in West German electronics industries looks to be a disappointing 5% for 1977, with little change seen for next year. This is the first in a series examining the electronics markets in various European countries.

Calculator designs staggered tuned circuits, 104

One way to ease the design of cascaded tuned circuits is to turn the complex calculations over to a calculator. This second part of a two-part series gives programs for Butterworth and Chebyshev networks.

IEDM to focus on LSI fabrication, 109

The agenda at this year's International Electron Devices meeting will feature finer microcircuit pattern geometry, with more powerful discrete devices running a close second. A number of papers in these areas and others come from Japan.

And in the next issue . . .

Microcomputer boards: the second and last part of the microcomputer roundup . . . leading industry executives ponder 1978 . . . when to specify circuit breakers.

EDITOR-IN-CHIEF: Kemp Anderson

EXECUTIVE EDITOR: Samuel Weber

MANAGING EDITOR: Arthur Erikson,
International

SENIOR EDITORS: Laurence Altman,
Ray Connolly, Lawrence Curran,
John Johnsrud, H. Thomas Maguire,
Stephen E. Scrupski, Gerald M. Walker

ART DIRECTOR: Fred Sklenar

ASSOCIATE EDITORS: Howard Wolff,
Alfred Rosenblatt

DEPARTMENT EDITORS

Aerospace/Military: Ray Connolly

Circuit Design: Vincent Biancomano

Communications & Microwave:

Richard Gundlach

Components: Lucinda Matterna

Computers: Raymond P. Capece

Consumer: Gerald M. Walker

Instrumentation: Stephen E. Scrupski

New Products: H. Thomas Maguire,

Michael J. Riezenman

Packaging & Production: Jerry Lyman

Solid State: Laurence Altman

CHIEF COPY EDITOR: Margaret Eastman

COPY EDITORS: Ben Mason, Mike Robinson

ART: Charles D. Ciatto, *Associate Director*
Paula Piazza, *Assistant Director*

EDITORIAL SECRETARIES: Janet Noto,
Penny Kaplan

EDITORIAL ASSISTANT: Marilyn B. Rosoff

FIELD EDITORS

Boston: Lawrence Curran (Mgr.)

Pamela Hamilton

Los Angeles: Larry Waller (Mgr.)

Midwest: Larry Armstrong (Mgr.)

New York: Bruce LeBoss (Mgr.)

San Francisco: Bernard Cole (Mgr.)

Judith Curtis

Washington: Ray Connolly (Mgr.)

Frankfurt: John Gosch

London: William F. Arnold

Paris: Arthur Erikson

Tokyo: Charles Cohen

McGraw-Hill World News

Editor: Michael Johnson

Brussels: James Smith

Milan: Andrew Heath

Moscow: Peter Hann

Paris: Andrew Lloyd

Stockholm: Robert Skole

Tokyo: Robert E. Lee

PUBLISHER: Dan McMillan

ADVERTISING SALES MANAGER:

Paul W. Reiss

MARKETING ADMINISTRATION MANAGER:

Wallis Clarke

CIRCULATION MANAGER: Karl Peterson

MARKETING SERVICES MANAGER:

Tomlinson Howland

RESEARCH MANAGER: Margery D. Sholes

For two decades, *Electronics* has prepared an annual survey and forecast of the electronics marketplace in the United States. Some dozen years ago, that effort was expanded to include Western Europe and, more recently, Japan. *Electronics'* combined forecast covers the leading Western electronics centers and is about as worldwide as you can get, since hard figures for the Eastern Bloc countries are nearly impossible to come by.

The big report will be published in the Jan. 5 issue, and the editors are still hard at work assembling the final numbers for the hundreds of product categories that we list, as well as reporting on the latest industry trends.

In this issue, though, you'll find the first installment of our annual markets story. On page 69 is a report on West Germany, the first in a series of Probing the News profiles on the half-dozen leading Western European electronics markets. In succeeding issues will be articles about France, Great Britain, Italy, Scandinavia, and Spain.

Technical meetings are, it should go without saying, a very important source of news on what is happening at the leading edge of technology. One of the most important meetings in the electronics field is the International Electron Devices meeting. For a number of years now, we have been putting together a preview of that meeting, spotlighting the more significant developments that are expected to surface there.

This year's report points to the big interest that will be generated by the continuing progress of microcircuit geometry toward finer and finer

patterns, by improvements in discrete devices, and by the widening of Japanese participation in technical sessions. In fact, one of the highlights is the paper by Yasuo Tarui, head of the cooperative laboratory that is spearheading Japan's efforts in very-large-scale integration.

So, for a detailed view of where electron-device technology is heading—from electron-beam fabrication to some intriguing breakthroughs in power semiconductors—be sure to read the IEDM roundup starting on page 109.

Displays serve a vital role in transferring information across the man/machine interface. So it's no wonder that researchers around the world keep on trying to improve existing displays or invent better ones. Now, from West Germany, comes one of those improvements. Combining principles from liquid-crystal displays and fluorescent signs, the device overcomes the biggest disadvantages of LCDs: lack of readability in dim light.

The device, developed at West Germany's Institute for Applied Solid State Physics and in prototype development at Siemens AG in Munich, is of interest in itself, but it also represents the countless thousands of innovations that are being carried on right now in the world-wide technology we call electronics. For a look at how this device works, turn to the article by Siemens' Martin Bechtler and Hans Krüger that starts on page 113.

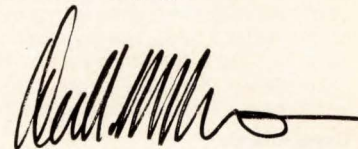

December 8, 1977 Volume 50, Number 25 95,825 copies of this issue printed

Published every other Thursday by McGraw-Hill, Inc. Founder: James H. McGraw 1860-1948. Publication office 1221 Avenue of the Americas, N.Y., N.Y. 10020, second class postage paid at New York, N.Y. and additional mailing offices.

Executive, editorial, circulation and advertising addresses: Electronics, McGraw-Hill Building, 1221 Avenue of the Americas, New York, N.Y. 10020. Telephone (212) 997-1221. Teletype 12-7960 TWX 710-581-4879. Cable address: MCGRAW HILL L N E W Y O R K.

Subscriptions limited to professional persons with active responsibility in electronics technology. No subscriptions accepted without complete identification of subscriber name, title or job function, company or organization, and product manufactured or services performed. Based on information supplied, the publisher reserves the right to reject non-qualified requests. Subscription rates: in the United States and possessions \$14 one year, \$25 two years, \$35 three years, company addressed and company libraries \$20 one year, \$36 two years, \$50 three years; APO/FPO addressed \$35 one year only; Canada and Mexico \$16 one year, \$28 two years, \$40 three years; Europe \$40 one year, \$71 two years, \$100 three years; Japan, Israel and Brazil \$65 one year, \$115 two years, \$165 three years; Australia and New Zealand \$30 one year, \$170 two years, \$240 three years, including air freight; all other countries, \$45 one year, \$80 two years, \$112 three years. Limited quota of subscriptions available at higher-than-basic rate for persons allied to field served. Check with publisher for these rates. Single copies: \$4.00. Please allow four to eight weeks for shipment.

Officers of McGraw-Hill Publications Company: Gordon L. Jones, President; Paul F. McPherson, Executive Vice-President; Group Vice-President: Gene W. Simpson; Senior Vice-Presidents: Russell F. Anderson; James E. Boddorf, Planning & Development; David G. Jensen, Manufacturing; Ralph R. Schulz, Editorial; Vice-Presidents: Denis C. Beran, European Operations; David P. Forsyth, Research; Douglas Greenwald, Economics; James E. Hackett, Controller; Robert L. Leyburn, Circulation; Edward E. Schirmer, Sales.

Officers of the Corporation: Harold W. McGraw, Jr., President, Chief Executive Officer, and Chairman of the Board; Robert N. Landes, Senior Vice President and Secretary; Ralph J. Webb, Treasurer.

Title registered in U.S. Patent Office. Copyright © 1977 by McGraw-Hill, Inc. All rights reserved. The contents of this publication may not be reproduced in whole or in part without the consent of copyright owner.

Subscribers: The publisher, upon written request to our New York office from any subscriber, agrees to refund that part of the subscription price applying to copies not yet mailed. Please send change-of-address notices or complaints to Fulfillment Manager; subscription orders to Circulation Manager, Electronics, at address below. Change-of-address notices should provide old as well as new address, including postal zip code number. If possible, attach address label from recent issue. Allow one month for change to become effective.

Postmaster: Please send form 3579 to Fulfillment Manager, Electronics, P.O. Box 430, Hightstown, N.J. 08520.

\$295

U.S. PRICE



YOUR BEST BUY IN SWEEP FUNCTION GENERATORS

The Krohn-Hite Model 1200 offers linear sweep (up or down) plus sine, square or triangle waveforms from .2Hz to 3 MHz. Features include: 1500:1 tuning dial plus vernier; external VC and CV output; push button control; DC offset control; auxiliary TTL output; separate HI and LO outputs and much more! Take advantage of this price while we're in a generous mood. Call (617) 580-1660 for more details.

245

U.S. PRICE



SECOND BEST

LESS SWEEP The new Model 1000 has all the quality features of the 1200 except sweep!

KH KROHN-HITE CORPORATION

Avon Industrial Park, Avon, Mass. 02322 • (617) 580-1660

Circle 5 on reader service card

SALES OFFICES: **ALA.**, Huntsville (205) 534-9771; **ARIZ.**, Scottsdale (602) 994-5461; **CAL.**, San Jose (408) 292-3220, Inglewood (213) 674-6850; **COL.**, Denver (303) 773-1218; **CONN.**, W. Hartford (203) 525-7647; **FLA.**, Orlando (305) 894-4401; **GA.**, Atlanta (404) 455-1206; **HAWAII**, Honolulu (808) 941-1574; **ILL.**, Arlington Hts. (312) 394-3380; **KS.**, Overland Park (903) 384-2710; **LA.**, Lafayette (318) 984-3516; **MASS.**, Wakefield (617) 245-5490; **MICH.**, Southfield (313) 569-4497; **MINN.**, St. Paul (612) 645-5816; **MO.**, St. Louis (314) 731-5400; **N.M.**, Albuquerque (505) 255-2330; **N.J.**, Cherry Hill (609) 482-0059; **N.Y.**, Elmont (516) 488-2100, Rochester (716) 328-2230, Syracuse (315) 437-6666, Vestal (607) 785-9947; **N.C.**, Burlington (919) 227-3639; **OHIO**, Chesterland (216) 729-2222, Dayton (513) 434-8993; **OKLA.**, Tulsa (918) 299-2636; **ORE.**, Portland (503) 297-2248; **TEX.**, Dallas (214) 661-0400, Houston (713) 688-1431; **UTAH**, Salt Lake City (801) 942-2081; **VA.**, Falls Church (703) 573-8787; **WA.**, Bellevue (206) 454-3400; **CANADA**, Montreal, Quebec (514) 341-7630, Ottawa, Ontario (613) 235-5121, Toronto, Ontario (416) 445-9900, Vancouver, British Columbia (604) 253-5555, Halifax, Nova Scotia (902) 454-8321, St. John's, Newfoundland (709) 726-2422.

**A filter so precise,
filter characteristics
for every setting
are printed
on top.**



We've built a variable electronic filter that's so precise, it has enabled us to print the cutoff frequencies, center frequency, bandwidth, noise bandwidth and filter gain, for every setting, on top of the instrument. Besides being the easiest-to-use filters on the market, our 4200 series filters are twice as accurate, have less than half the self-noise, and provide 10 dB greater outband rejection than other filters. Frequency coverage is .01 Hz to 1 MHz. Built-in selectable post-filter gain and remote preamplifiers are optional. A Butterworth response is used in the NORMAL mode and a Bessel response in the PULSE mode (transient response is superior to conventional "RC" or "Low Q" modes of other filters).

For complete specifications and your free copies of our variable electronic filter application notes, write to: Ithaco, Box 818-7R, Ithaca, New York 14850. For immediate response, call John Hanson at 607-272-7640 or TWX 510-255-9307.

ITHACO

Readers' comments

Ink-jet's impact

To the Editor: As vice president of A. B. Dick Co. from 1969 to 1974, I was fortunate enough to lead the commercialization of ink-jet printing [Electronics Newsletter, Sept. 15, p. 33].

There is still a great deal of down-to-earth, thorough engineering required to produce products that will be commercially successful. Realistically, the technology is still in its infancy, and the opportunities are available for any company with the insights, the innovative perspectives, and the desire to become a leader in the field.

Further, I believe that the technology will be complemented by other nonimpact methods, such as facsimile or other electrophotographic duplication. Products derived from these technologies will, in all probability, form the base for the small "office of the future" and will be easily capable of interfacing with communications networks by either analog or digital transmission.

It has been apparent for some years that the worlds of computers and communications are drawing more closely together. The continuing commercialization of ink-jet printing is another step in that process.

W. Robert Stone
Wayzata, Minn.

Fast response

To the Editor: May I suggest that the answer to the traffic radar problem ["Highway radar eludes detectors," Sept. 15, p. 44], is not, as Mr. Daniel Langiani suggests [Readers' Comments, Oct. 27, p. 6], the use of the departure mode, but rather the elimination of traffic radars entirely.

Sometimes we can't "see the forest for the trees." Since when is speed inherently wrong? If we would concentrate on building better roads, with modern technology, we wouldn't have to worry about speed. Moreover, we would free the police to do something more productive with their time.

Lawrence S. Savell
Harbor City, Calif.

Share in the success you helped create ...

ANNOUNCING THE RCA BiMOS BONANZA.

BiMOS is the RCA Linear IC technology that is not only being made by the millions, but used by the millions.

Now we're adding new BiMOS products and new BiMOS prices so you can make even wider use of the highly cost-effective performance of BiMOS op amps.

CA3140 2-for-1 Bonanza

At our new price for the mini-dip 3140, you can buy twice as many as you could at the old. So now, for the same dollar, you can double your use of the most useful op amp since the 741.

CA3240 2-in-1 Bonanza

Our new CA3240E gives you two 3140's in one mini-dip package. At less than twice our new low 3140 price. Your new designs can be achieved with half as many packages.

And the 3240 is available now in prototype quantities. In both mini-dip and 14-lead DIP.

CA3140 CA307G Gold CHIP Bonanza

It's your choice. Two CA3140E's or one 3140 and one CA307G. They both have the same new low price. This BiMOS/Gold CHIP team-up gives you a variety of ways to beat the 741 where you want more performance. Or beat many premium Bifet types where you want lower price or greater availability.

Get your share of the BiMOS Bonanza now. Contact your local RCA Solid State distributor. Or contact RCA Solid State headquarters in Somerville, NJ; Sunbury-on-Thames, Middlesex, England; Quickborn 2085, W. Germany; Ste.-Anne-de-Bellevue, Quebec, Canada; Sao Paulo, Brazil; Tokyo, Japan.

Note: All price references are based on the unit prices in effect November 1, 1977. Prices optional with distributors.



**RCA Linear IC
experience is
working for you.**

RCA

Circle 7 on reader service card

WE'RE #1 IN EQUIPMENT RENTALS

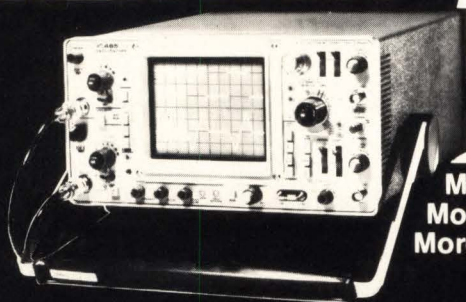

More people
More plant
More experience

The Continental concept of sales and service has grown to a team of more than 150 "Professionals" in 10 nation-wide offices.

Rental inventory, offices, service and calibration labs exceed 60,000 square feet of floor space.

In-house service, experienced personnel and four hundred thousand dollars/month in new equipment purchases keep us #1.

Rent with Confidence

Call Continental Rentals

Get our
FREE
Catalog

Div. Continental Resources, Inc.
175 Middlesex Turnpike, Bedford,
MA 01730 (617) 275-0850

FOR IMMEDIATE RESPONSE CALL:
N.E. (617) 275-0850; L.I. (516) 752-1622;
NY, NJ (201) 654-6900;

Florida (800) 638-4050;
Gtr. Phila. (609) 234-5100;
Wash., D.C. area (301) 948-4310;
Mid West (312) 439-4700;
So. Central (800) 323-9656;
Costa Mesa, CA (714) 540-6566;
L.A., CA (213) 638-0454;
Santa Clara, CA (408) 735-8300.

News update

■ For 15 years, Grumman Aerospace Corp. in Bethpage, N. Y., has supplied automatic test equipment to the Department of Defense and NASA in support of its own weapons and space systems. Now the firm is intent on becoming a leading supplier of commercial ATE systems and instruments.

Earlier this fall, Grumman served notice of its official entry into the commercial field with the sale of its first CAT-M system to General Electric Co. in Utica, N. Y. The 10-megahertz digital test system is a miniaturized version of the CAT-D computerized automatic test system used by the military [*Electronics*, Feb. 19, 1976, p. 30], notes ATE systems program manager John Keenan. Whereas CAT-D was a \$400,000 system able to accommodate up to 480 test pins, the basic CAT-M has a 120-pin capability, expandable to 240 pins in 24-pin increments, and sells for \$130,000 to \$150,000—"making it an ideal system for factory test applications of original-equipment manufacturers and other commercial customers," says Keenan.

Last month, Grumman also took the wraps off a high-performance analog test system, the CAT-A, selling between \$200,000 and \$350,000, depending on features. A Hewlett-Packard Co. 21MX mini-computer, with 32 k-by-16-bit words of semiconductor memory, and a 15-megabyte dual disk system that will provide control and mass storage functions for CAT-A and CAT-M will be available in 12 and 6 months, respectively.

The focal point for testing on the CAT-A, says Keenan, is the Multiple Matrix Switch, which routes all analog and digital signals, as well as power, through its front-mounted coaxial interface to the unit under test. It is controlled by an Intel Corp. 8080 8-bit microprocessor, as is an arbitrary function and pulse generator that provides three independent, fully programmable stimulus channels. Now in prototype stage, the generator is to be available in March 1978.

Bruce LeBoss

New Concept in Digital Filtering Multiplier-Accumulator

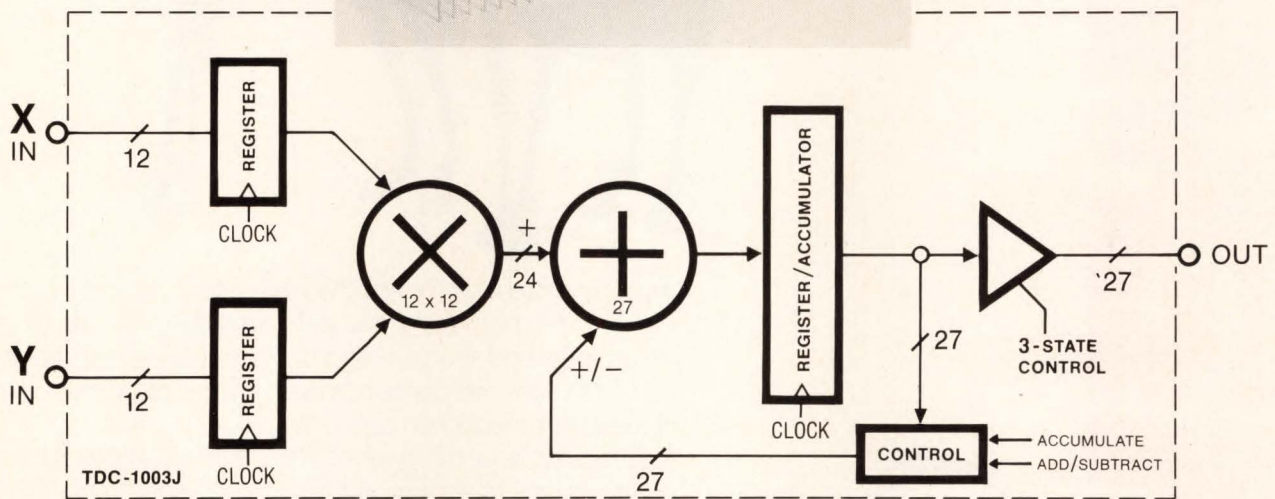
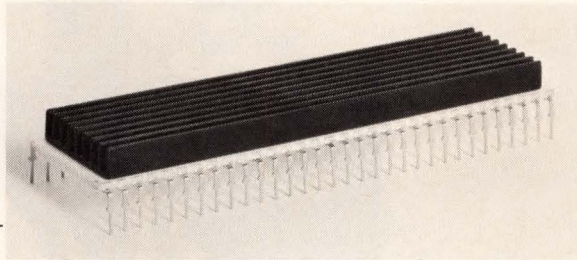

175 ns, 12 bits - \$140 in 100's

IDEAL FOR

- FFT Processing
- Digital Filter - Recursive
- Digital Filter - Non-Recursive
- Sum of Products
- Complex Multiplication
- General Signal Processing Applications

12 x 12 Bit Parallel Multiplier with a 27 Bit Accumulator/Subtractor - Single Chip, Bipolar, TTL.

The new TDC-1003J features controllable accumulation and subtraction. It requires much lower power than equivalent MSI multiplication-accumulation systems, yet features much faster speed.

Let us show you how you can add functions, simplify the design... and reduce total circuit cost. Contact your local TRW Electronic Components field sales office or call us at (213) 535-1831, or send the coupon.

TRW LSI Products

An Electronic Components Division of TRW, Inc.,
P. O. Box 1125
Redondo Beach, California 90278

Please send data sheets on the new 12x12 bit parallel Multiplier / Accumulator.

NAME _____

COMPANY _____

DIV/DEPT _____ MAIL CODE _____

ADDRESS _____

CITY _____

STATE _____ ZIP _____

E-12

ALL TRW LSI PRODUCTS ARE NOW IN STOCK AND DISTRIBUTED EXCLUSIVELY BY HAMILTON /AVNET

TRW LSI PRODUCTS

For Digital Signal Processing

64K MEMORY

**EVER SINCE OUR GREAT
MEMORY BREAKTHROUGH
THE OLD INDUSTRY
STANDARD AIN'T WHAT IT
USED TO BE.**



When we introduced the Fairchild 64K F464, we said it had the stuff to be the industry standard someday. We even started out with a second source. Apparently, a lot of memory people took us seriously. Response has been so positive, we've already increased our production capacity.

Plugging the gap between MOS and magnetic memories, the F464 is the first semiconductor Bulk Storage Device (BSD).

The F464 is the densest semiconductor memory ever made. A compact die size of less than 40,000 mil² — not much larger than today's 16K RAMs. All packaged neatly in a standard 0.3-inch 16-pin DIP.



HIGH PERFORMANCE, LOW OVERHEAD.

There has never been a device like the F464. It's a 65,536 x 1-bit dynamic serial memory organized as 16 randomly accessible shift registers of 4096 bits each. The four address bits are decoded on-chip to select which one of these 16 shift registers is to be accessed. Control inputs include Write Enable and Chip Select. It requires standard power supplies of +12 V and ±5 V.

All inputs (except the clocks) are directly TTL compatible. The two high-frequency and two low-frequency clock inputs are low capacitance 12 V signals which can be easily generated with simple logic.

The logic required to generate this 4-phase clock costs less than one memory chip and is generated only once per system.

Part Number	Maximum Frequency (MHz)	Maximum Active Power Dissipation (mW)
F464-4	2	238
F464-3	4	298
F464-2	5	336

Speed and power dissipation for F464 family.

So you don't pay for memory overhead every time you expand. This lower overhead cost means lower system costs to you. Maximum data rates range from 2 MHz (F464-4) to 5 MHz (F464-2). The minimum frequency for the SPS structure is 1 MHz. Since all 16 registers shift simultaneously, the average random access time (called latency) is only 410 μ s at 5 MHz — a truly significant performance improvement over other bulk memory technologies! And, at the same time, the power dissipation remains low: typically 3.5 μ W/bit at 5 MHz, and 0.6 μ W/bit during standby at 1 MHz. Three part types are available to cover a wide range of maximum speed requirements.

These performance benefits make the F464 a natural for hybrid head-per-tracks or fixed-head discs, extended cache, and many other high-density memory applications.

Other outstanding F464 characteristics include solid state ruggedness, speedy data rates and the most semiconductor memory per square centimeter in the industry. Not bad for a small chip!

LOW COST, HIGH VERSATILITY.

The new F464 is three to four times less expensive per bit than RAMs. It is also cost-competitive with all fixed-head discs.

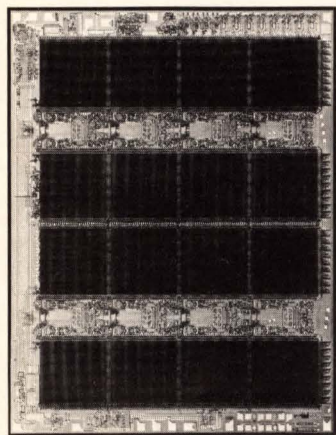

So there are no trade-offs between price and performance. The F464 gives you the best of both.

F464 applications range from typical computers to atypical portable memories and digital delays.

And once you order, you can rest assured that you'll get prompt delivery. Fairchild has a 250,000-square-foot plant in San Jose, California that's totally dedicated to VLSI technology and production.

FOLLOW THE LEADER.

Fairchild pioneered CCD technology. We introduced the world's first commercially available charge-coupled device in 1973. Today, we offer the world's broadest line of CCD products. It stands to reason we'd be the ones to make CCD memories a reality.

For more information on the F464 (or our other CCD products), contact your Fairchild sales office or representative today. Or write directly to our MOS/CCD Division at Fairchild Camera and Instrument Corporation, P.O. Box 880, Mountain View, California 94042. TWX: 910-373-1227.

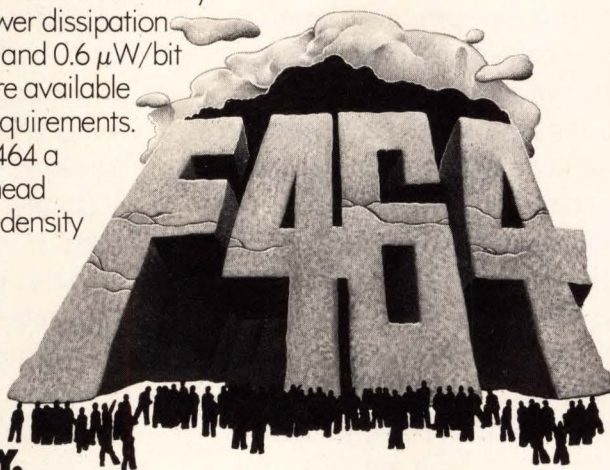

FAIRCHILD
CALL US ON IT.

Countering Japanese competition

In the face of increasing Japanese competition in high-technology areas of electronics — semiconductors and data processing, for example — one may legitimately worry about whether the sad history of consumer electronics will be repeated. It is encouraging, therefore, when executives such as Digital Equipment Corp.'s cofounder and president, Kenneth H. Olsen, reject the concept. Asked whether the American minicomputer industry may repeat the consumer electronics industry's 15-year losing battle against Japanese imports, Olsen rejects the analogy. "They didn't lose any battles," he says, "they gave up."

Significantly, his view coincides with that of H. William Tanaka, whose Washington law firm represents the Electronic Industries Association of Japan. Though not an EIA-J spokesman, Tanaka believes that too many U. S. consumer electronics makers let too many new and lucrative markets go by default. Moreover, he cites case histories to support his argument.

Fundamentally, Tanaka's view is that American manufacturers are not hungry enough. One measure of that somewhat simplistic truth, however, is the continuing howls of hunger being heard in Washington from American corporations that have already lost markets to Japanese competition. Now they are losing more money in hiring attorneys and lobbyists in their belated attempts to get the Carter Administration to lean on the Japanese and set limits on their high-technology exports to America.

However, American electronics manufacturers would be foolish to count on getting their lost markets back solely on the basis of pressure by the White House to rectify the trade imbalance with Japan. More than electronics is involved. If, for example, Japan moves to import more U. S. agricultural products to offset its exports here, that will be fine with the U. S. Treasury, where trade

balances are measured in dollars, rather than technologies. The situation in Congress is somewhat different, of course, as more Congressmen recognize that increased Kansas wheat exports provide no solace for the unemployed electronics worker in Illinois, Ohio, or Pennsylvania. This fact of life is generating protectionist pressures in Congress, and a White House trade mission is using that lever in Tokyo, too.

It must not be forgotten that Japan has political problems, also. Prime Minister Takeo Fukuda appears willing to give more equal trade a better try, if his recent cabinet reshuffling is any measure. Nevertheless, he is limited in what he can achieve. For example, the logical increase in agricultural imports by Japan is unlikely to come about soon, if at all. Fukuda's own party draws basic support from rural areas, and Japan's limited agricultural capability is nourished by import barriers — one more example that an issue need not have economic validity to be politically sound.

Some American technologists and managers may put their faith in such an economically invalid principle as increased protectionism if they can improve their own profits in the short term. But they may be only prolonging their agony, because the Japanese companies' move to establish production facilities in the U. S. may continue to grow.

Whatever comes out of the current Tokyo trade negotiations — and not much of significance for electronics is expected soon — America's electronics industries would do best to adopt the strategy of DEC's Olsen and arm themselves with superior technology to compete with Japan in the marketplace, rather than try to erect new and divisive trade barriers. Indeed, what is needed is a lowering of Japan's import barriers, and American industry must push harder than ever for U. S. government negotiation of such reductions.



24 GHz

—30 dBm sensitivity, FM tolerance standard

Just those three features alone put Systron-Donner's Model 6054B Microwave Counter in a class by itself! But there's lots more:

Complete Coverage: From 0.02 to 24 GHz in one band with one connector input. *Eleven* digits give you fully displayed readings.

Sensitivity: —30 dBm to 10 GHz; —25 dBm to 18 GHz; —20 dBm to 24 GHz.

Dynamic range: No dead zone! Operative over the complete range up to +30 dBm (1 watt).

Protection: Unlike other counters offered to date, the Model 6054B provides early warning of pending overload conditions via flashing LED's.

FM tolerance: Full channel loading and heavily modulated signals with rates up to 10 MHz are measured easily with S-D's FLACTO™ technique.

IEEE-488: For systems applications, the 6054B is fully compatible with IEEE-STD-488-1975.

Speed: Fast acquisition and 1 Hz resolution in one second are provided over the entire frequency range.

Discriminator output: Gives the operator a visual picture of any modulation characteristics on the carrier.

Other models: If you don't need 24 GHz coverage, S-D offers four counters starting at \$4,600. (U.S. price only).

To find out more about the performance leaders in microwave counters, call Scientific Devices or contact S-D at 10 Systron Drive, Concord, CA 94518. Phone (415) 676-5000. Overseas, contact Systron-Donner in Munich; Leamington Spa, U.K.; Paris (Le Port Marly); Melbourne.

SYSTRON  DONNER

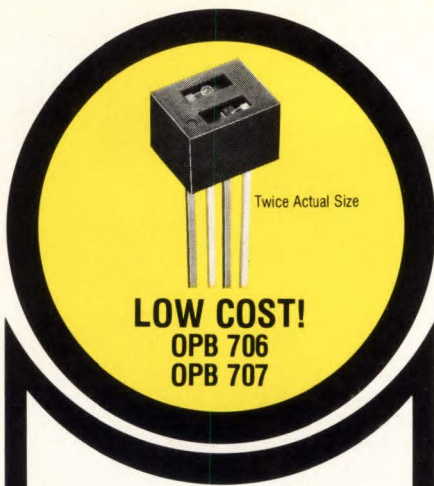

OPTRON REFLECTIVE OBJECT SENSORS

NEW, LOW COST DEVICES
OFFER HIGH RELIABILITY
FOR NON-CONTACT SENSING

OPTRON's new OPB 706 and OPB 707 reflective object sensors provide solid state reliability at a low cost for non-contact sensing applications.

Ideal applications for the OPB 706 and OPB 707 include detection of edge of paper or cards, EOT/BOT sensing, tachometers, motor speed controls, and proximity detection.

The devices combine a high efficiency solution grown gallium arsenide infrared LED with a silicon N-P-N phototransistor (OPB 706) or maximum sensitivity photodarlington (OPB 707) in a plastic package. The photosensor senses radiation from the LED only when a reflective object is within its field of view.

With LED current of 20 mA, the output of the OPB 706 is typically 750 μ A when the device is positioned 0.050 inch from a 90% reflective surface. Under similar operating conditions, the output of the OPB 707 is typically 35 mA.

A built-in light barrier in both devices prevents response to radiation from the LED when there is not a reflective surface within the field of view of the sensor. With no reflective surface, the maximum sensor output due to crosstalk between the sensor and LED is 0.200 μ A and 10 μ A for the OPB 706 and OPB 707.

The OPB 706 and OPB 707 and other low cost, high reliability OPTRON reflective transducers are immediately available. Custom designed versions are available on request.

Detailed information on the OPB 706 and OPB 707 reflective object sensors and other OPTRON optoelectronic products ... chips, discrete components, optically coupled isolators, and interrupter assemblies ... is available from your nearest OPTRON sales representative or the factory direct.



OPTRON, INC.

1201 Tappan Circle
Carrollton, Texas 75006, U.S.A.
TWX-910-860-5958
214/242-6571

People

Mueller urges development of new communications gear

George E. Mueller (pronounced Miller) has some advice for timid executives of computer-oriented communications firms. "Forget hang-ups about overregulation and unfair competition," he chides. They can damp the "bold, creative" actions that could lead to a bonanza in new equipment.

As chairman and president of System Development Corp., he has plenty of suggestions for products that such companies should be developing, ones that he thinks SDC could apply in its own design of computer and communications systems. He offered this counsel to the annual meeting last month of the Computer and Communications Industry Association, a group of independent manufacturers and suppliers.

Best known for directing the U. S. manned space flight program from 1963 until astronauts landed on the moon in 1969, Mueller at 59 heads a firm based in Santa Monica, Calif. Touching most parts of the worldwide communications business, it serves as prime contractor for designing and installing turnkey data-processing networks.

Data compression. Topping his list is a pressing demand for efficient data-compression techniques and gear. "We're simply going to have to get smarter about how we use our available bandwidth. The work done in facsimile is just a start, but compressing data by a factor of only five or so will not meet our needs."

Mueller also recommends that companies get busy using miniaturized logic technology, "to package an encoder-decoder in a phone receiver, fast enough to send a message directly over the line and reassemble it in a form we can use." No such economical instrument now exists, he points out.

Further, he would like the telephone itself to be improved. It is "now little better than a recording in handling the voice inflections that are important in face-to-face meetings." Mueller's suggestion: "stereo



Adviser. Data communications could use creative design, says SDC's Mueller.

with high-fidelity transmitters and receivers might do much to improve the personal interaction possible over phone lines."

Lack of such products is apparent to designers at SDC which Mueller has headed since 1971. Regarded by associates as exacting but fair, Mueller has directed the firm through a highly successful transition period. From a nonprofit status with \$45 million in revenues, 95% from the Government, primarily Air Force contracts, SDC has grown to a \$130 million operation, only 40% dependent on military customers. It is no longer nonprofit and indeed hopes to go public.

Lamond, Finch reemphasize National's digital technology

While development of consumer products is still a major concern at National Semiconductor Corp., the firm's rough treatment in the consumer market has triggered a de-emphasis on that area and a corresponding reemphasis on basic digital and linear technology. To do this, National has been quietly putting into place a new management team, two key men of which are Pierre Lamond and John Finch.

"Getting us on the right course, that's my principal concern since coming back," says Lamond, 46,

Precision quad op amps.

Precision.

PMI's new OP-09 and OP-11 are pin-compatible with the un-precision quads now on the market.

The quad op amp has finally come of age. With the introduction of the OP-09 and OP-11, PMI has made it a truly workable reality. Consider:

Low V_{OS} and other goodies.

Since quads can't be nulled—there aren't enough pins available—the user is at the mercy of whatever input offset voltage (V_{OS}) he happens to get. PMI refined the manufacturing process to get V_{OS} under control. We came up with the lowest V_{OS} of any quad op amp made today.

At the same time, we gave the OP-09 and OP-11 the highest gain and the lowest drift of any quad op amp. We expanded bandwidth, reduced offset and supply current, and increased the slew rate. Here it is in black and white:

OP-09/OP-11 Features

	TYP.	MIN./MAX.
• Low V_{OS}	0.30 mV	0.5 mV MAX.
• Low offset current	8.0 nA	20 nA MAX.
• Low supply current (Total for all 4)	3.5 mA	6 mA MAX.
• Voltage gain	250K	100K MIN.
• Slew rate	1.0 V/ μ S	0.7 V/ μ S MIN.
• Matched positive and negative slew rate for low distortion.		
• Bandwidth		2.0 MHz MIN.

We make them match.

Another important advantage: we guarantee that all four op amps will match in terms of V_{OS} and CMRR. Here's how we specify them:

Matching Characteristics

Parameter	Symbol	OP-09A/E OP-11A/E			OP-09B/F OP-11B/F			Units
		Min	Typ	Max	Min	Typ	Max	
Input Offset Voltage Match	ΔV_{OS}	—	0.5	0.75	—	0.8	2.0	mV
Common Mode Rejection	$\Delta CMRR$	—	1.0	20	—	1.0	20	μ V/V
Ratio Match		94	120	—	94	120	—	dB

(Match exists between all four amplifiers)

Circle 15 on reader service card

DUAL INSTRUMENTATION AMPLIFIER 2 OP AMP DESIGN
(1/2 CIRCUIT SHOWN)

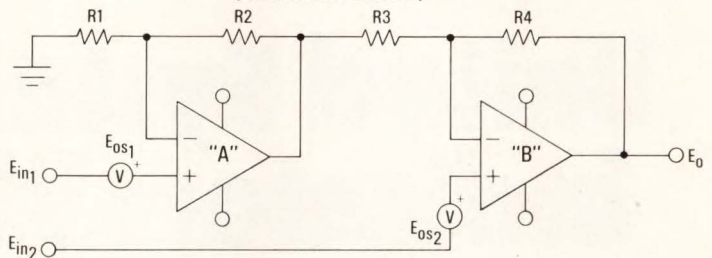

These matching dc characteristics should interest you. They reduce distortion, improve system performance, and simplify your design. But that's not all.

We've given all four op amps symmetrical positive and negative slew rates—an important thing to keep in mind for audio system design.

It's fair to say that the OP-09 and OP-11 are the most accurate, most advanced and the only **precision** quad op amps on the market. And they **are** on the market—available now, today.

Like to check one out? Be our guest. Just drop us a line on your company's stationery, telling us if you'd prefer an OP-09 (4136 pinout) or an OP-11 (148/4741 pinout). We'll be glad to send literature and a sample.

Precision Monolithics Incorporated
1500 Space Park Drive
Santa Clara, California 95050
(408) 246-9222.
TWX: 910-338-9222
Cable MONO.

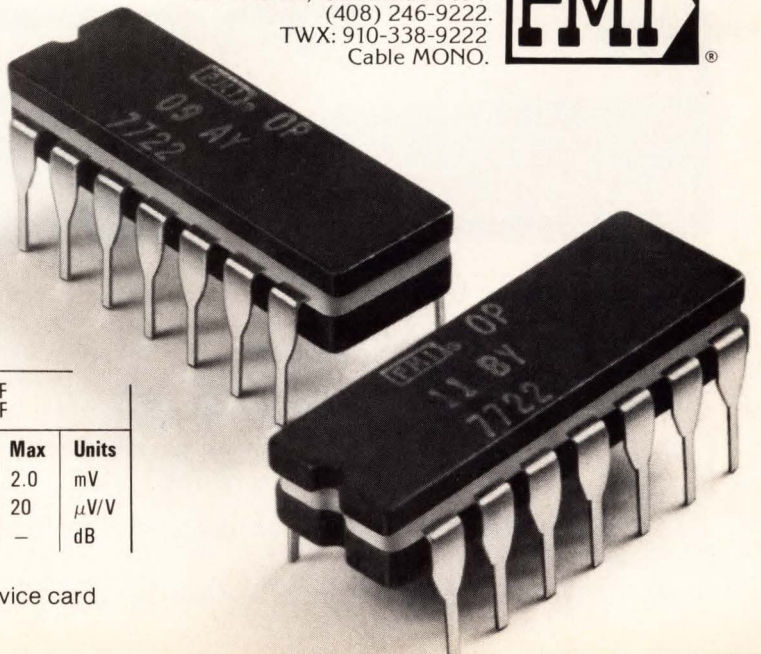

People

National's newly appointed vice president and director of technology. A founder of the Santa Clara, Calif., semiconductor manufacturer, he recently returned to his old company from a stint as president of Advent Corp. In reemphasizing basic technology, he says, "my major thrust is developing next-generation LSI technology for the EDP, industrial, and communications marketplace."

Four areas. Lamond has staked out four major areas of advanced technology for development: digital large-scale integrated circuits, subnanosecond logic arrays, charge-coupled devices, and magnetic bubbles. "We've already begun developing a 2-micrometer MOS process for memory and microcomputer chips," he says. "We'll use it first in 65-k CCD memories next year and then apply it to RAMS and microprocessors after that. We can do the 2- μ m process with electron-beam masks and standard photolithography, tools we already have.

"We're also putting increased emphasis on wafer fabrication techniques, such as achieving better tolerances and thinner, purer oxides and junction depths," he continues. "These become more and more critical as you reduce circuit geometries."

As for magnetic bubbles, "we've formed a program to look at the materials and circuit features of bubbles to see how viable the technique is for mass memories."

For John Finch, National Semiconductor's new vice president and general manager of semiconductor components, the big effort will be in manufacturing—putting the firm ahead in scaled n-channel metal-oxide-semiconductor processes and getting the new electron-beam mask-making machines onstream.

"In n-MOS especially, Intel doesn't have such a substantial lead anymore," says the 42-year-old process expert who joined National in 1967. "We are in development with a scaled n-MOS process equivalent of Intel's H-MOS [high-performance MOS]. Within a year or so, it will be National and Intel neck and neck in process technology."

+1 1.008 mV 240.5 ACV
 198.4 PSI 139.45 GPM
 -180.0 °C +1084.5 °F
 1.386 AMPS 2570.85 RPM
 220.0 OZ/SEC 1303 LBS

United Systems' Indicators Will:

- MEASURE voltage and current; ac, true rms or dc.
- CONVERT the output of any transducer/transmitter to display in engineering units.
- DISPLAY temperature (C or F) directly from thermocouple, RTD, or thermistor sensors.
- INTERFACE readily into your system by optional "single line enable" parallel BCD output.
- INDICATE when a predetermined limit is exceeded, through relay closure or logic level output from optional internal comparator alarm.

And with United Systems' exclusive adaptors these indicators change, in the field, to perform any measurement listed above and more!

For additional information contact your United Systems Representative or call the factory (513) 254-6251.

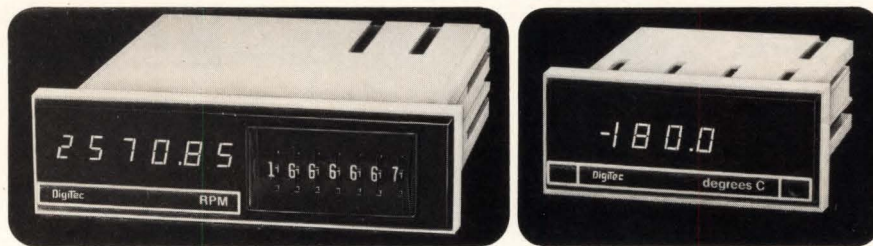

DigiTec.

**UNITED
SYSTEMS
CORPORATION**

918 Woodley Road, Dayton, Ohio 45403
(513) 254-6251, TWX (810) 459-1728

United Systems Corp: Precision measurements to count on



EAROM

In a class by itself.



GI's EAROM is the most advanced memory chip available. It can do more things than a RAM, ROM, PROM or EPROM.

EAROM is non-volatile. Unlike a RAM, it doesn't lose its data in a blackout, or from battery failure. Another thing. An EAROM is *electrically* erasable and reprogrammable. So you don't get stuck with costly inventories like you can with one-shot programmed ROMs and PROMs. With an EAROM you're never locked in. You can program and reprogram it. You can erase and rewrite it electrically over and over again—in circuit or at-the-bench without an ultraviolet light. And unlike UV EPROMs, stray sunlight or X-rays can't accidentally wipe out an EAROM's data. EAROM is word alterable, too. There's no need to clear the memory completely.

Only General Instrument Microelectronics makes a full line

BITS	MEMORY ORGANIZATION	PART NUMBER	READ ACCESS	ERASE/WRITE MODE
512	32 × 16	ER2051	3μs	16 bit word
1024	256 × 4	ER1105	2μs	32×4 block/4 bit word
1400	100 × 14	ER1400	2.8μs	14 bit word
		ER2401A	2μs	1024×4 block/4 bit word
		ER3400	650ns	4 bit word or 4 bit word
8192	2048 × 4	ER3401	950ns	1024×4 block/4 bit word
		ER2805	2μs	2048×4 block/4 bit word

of EAROMs with bit densities from 512 to 8192. In fact, we wrote the book on EAROMs. Find out how GI microcircuitry can help put your product in a class by itself. Write or call General Instrument Microelectronics, 600 West John Street, Hicksville, New York 11802. Telephone (516) 733-3107.

We help you compete



**GENERAL INSTRUMENT CORPORATION
MICROELECTRONICS**



Intel delivers Intellec[®] There's no shorter route

Intellec[®] is Intel's Microcomputer Development System that delivers in-depth support. And, in-depth support gets your microcomputer based products to market faster and easier.

Intellec is the only system that supports the entire line of Intel microcomputers. It's the only system with ICE In-Circuit

Emulation for the 8080, 8085, 8048 and Series 3000 microcomputers. And Intellec is the only development system with a resident high level language for microcomputer system programming.

We call that language PL/M. It has become the most widely used language for microcomputer programming and can cut months off your software devel-



in-depth support. from design to production.

opment cycle. And, because PL/M is resident in the Intellec system, you put an end to timeshare computer charges. You just can't get that kind of power and efficiency from any other system.

We've made Intellec easy to use. You communicate with the system in simple English-like statements. You can write application programs in small, manageable modules and link them together with other programs from the diskette library for loading into your microcomputer's PROM or EPROM memory.

To simplify hardware/software integration and system debugging, Intel's unique ICE modules give you a "diagnostic window" into the operation of your system. The ICE software system is the only one that lets you control, monitor and analyze all microcomputer functions using symbolic references for addresses



and data. And the new ICE-85™ provides expanded in-system emulation capability, extending the window to your entire microcomputer system.

You can count on Intel for in-depth support in other areas, too. Like user application assistance, complete documentation, training programs and design seminars worldwide, and a users' software library with over 275 programs and growing.

That kind of in-depth support is the reason more designers are using more Intel microcomputers and Intellec development systems than all others combined.

To find out how Intellec can get you on the road to faster and easier microcomputer development, contact your nearest Intel distributor or sales representative. For a local demonstration or a copy of the Intellec brochure, use the reader service card or contact us directly. Intel Corporation, 3065 Bowers Avenue, Santa Clara, California 95051. Telephone (408) 987-8080.

intel® delivers.

Circle 271 for technical information
Circle 272 for technical information and a demonstration



the widest selection of SCR power supplies in the whole wide world

The off-the-shelf selection is almost endless, with 1- and 3-phase rack-mounted power supplies from 500 to 10,000 watts DC. Call for complete information and prices, or write for our catalog.

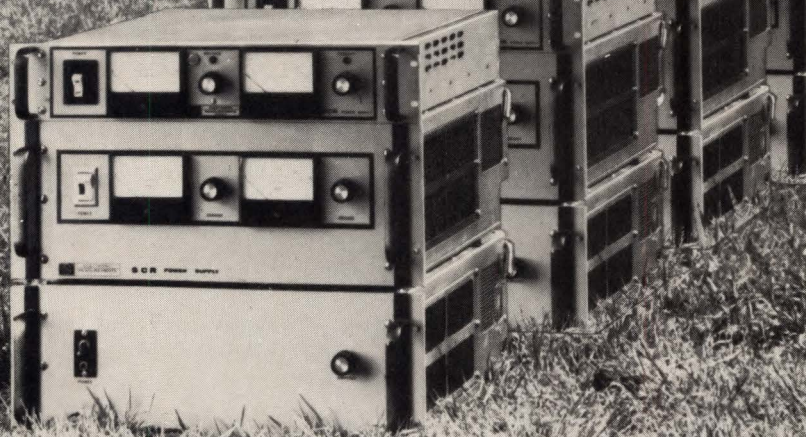

ELECTRONIC MEASUREMENTS INC.

405 Essex Road, Neptune, N.J. 07753
Phone (New Jersey) 201-922-9300 (Toll free) 800-631-4298
Specialists in Power Conversion Equipment

Meetings

Computer Networks Symposium, National Bureau of Standards and IEEE, NBS, Gaithersburg, Md., Dec. 15.

1978 Winter Consumer Electronics Show, Electronic Industries Association, Convention Center and Hilton Hotel, Las Vegas, Jan. 5-8.

Conference on Integrated and Guided Wave Optics, IEEE, Salt Lake Hilton, Salt Lake City, Utah, Jan. 16-18.

Reliability and Maintainability Conference, IEEE, Biltmore Hotel, Los Angeles, Jan. 24-26.

Internecon/Japan and International Microelectronics Exhibition, Industrial and Scientific Conference Management Inc. (Chicago), Harumi Exhibition Center, Tokyo, Jan. 25-28.

Power Engineering Society Winter Meeting, IEEE, Statler Hilton Hotel, New York, Jan. 29-Feb. 3.

Automated Testing for Electronics Manufacturing Seminar and Exhibit, Circuits Manufacturing Magazine (Boston, Mass.), Los Angeles Airport Marriott Hotel, Los Angeles, Jan. 30-Feb. 1.

CLEOS—Conference on Laser and Electro-Optical Systems, IEEE and OSA, Town and Country Hotel, San Diego, Feb. 7-9.

International Solid State Circuits Conference, IEEE, San Francisco Hilton, San Francisco, Feb. 15-17.

Computer Science Conference, ACM, Detroit Plaza Hotel, Detroit, Feb. 21-23.

Nepcon West and Semiconductor Hybrid Microelectronic Symposium and Exhibits, Industrial & Scientific Conference Management Inc. (Chicago), Anaheim Conference Center, Anaheim, Calif., Feb. 28-March 2.

Compon Spring, IEEE, Jack Tar Hotel, San Francisco, Feb. 28-March 2.

From only 90 seconds of transmission time, HP's new graphic plotter drew this chart in four colors, picked up its pens, and put them away.

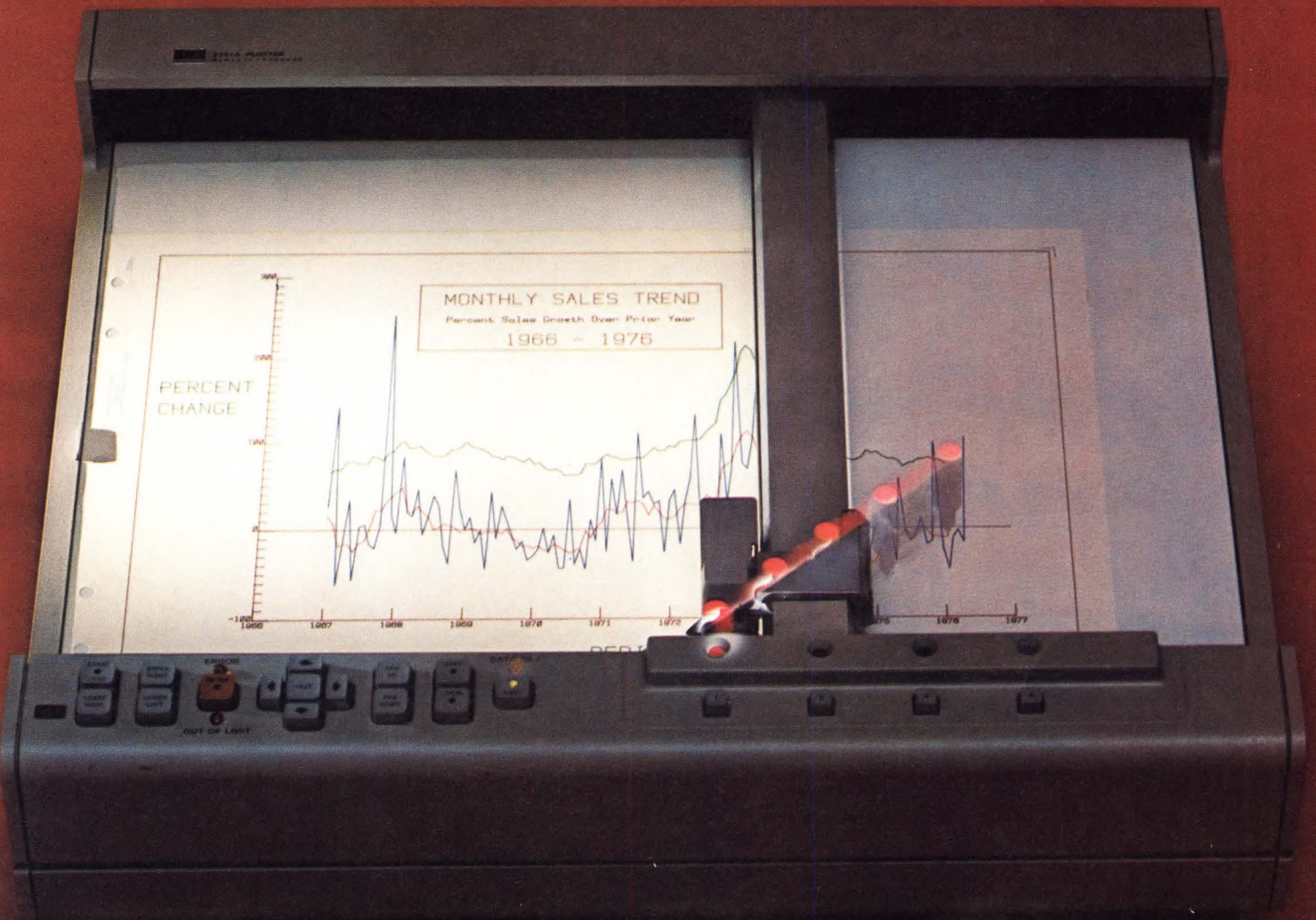

Neat, isn't it.

Getting this kind of graphics from complex computer data has always been a long, drawn-out problem. Now, arcs, circles, dashes, dots, and alphanumeric—routine shapes that normally take lengthy programs—are quickly drawn by single commands.

And, with only one transmission, any series of shapes and moves can be stored in the plotter's memory and repeatedly executed as macroinstructions.

But the neat trick is the way our plotter instantly changes colors via a program-

mable command or front panel control. Four long life HP pens stay tucked away until the plotter picks one out, draws, and puts it back (with the cap on).

You have to see it to believe it. HP's remarkable new Model 7221A (RS 232C interface) uses an internal memory and 40 commands that plot efficiently to save you money in computer and transmission time. And it costs just \$4,600 (domestic USA price only), with full service leasing available in the USA for as little as \$218 per month.

See your Hewlett-Packard

representative for complete details on how you can have economical high quality multi-color charts and diagrams of your computer-generated information with the new Model 7221A Graphic Plotter. It's the neat solution to the problem of long, drawn-out hard copy graphic displays.

11712

HEWLETT  **PACKARD**

1507 Page Mill Road, Palo Alto, California 94304

For assistance call: Washington (301) 948-6370, Chicago (312) 255-9800, Atlanta (404) 955-1500, Los Angeles (213) 677-1282

Forget our products.

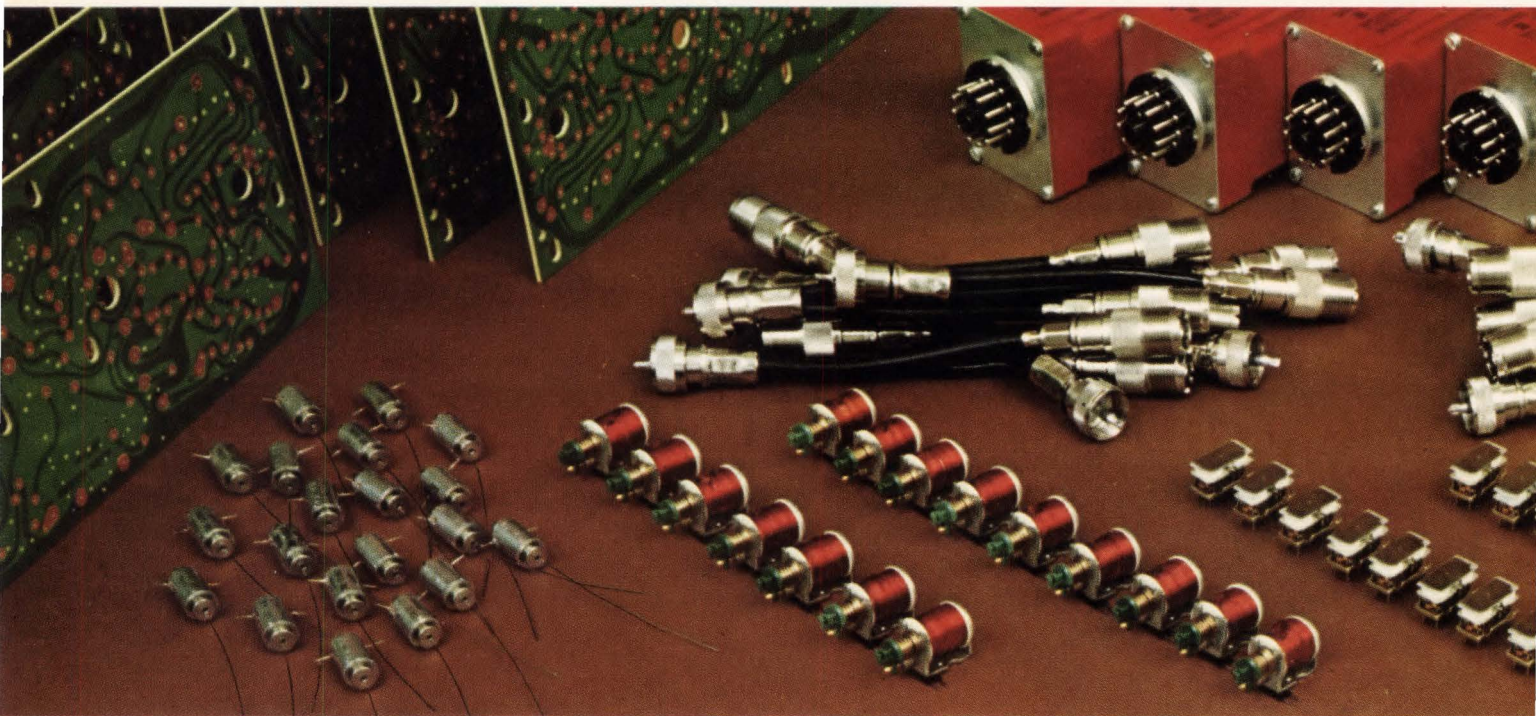

Major manufacturers forget them all the time. Polaroid. DEC. Honeywell. Tandy. Foxboro. Ford. Bendix.

Our products are easy to forget. Because, once installed, all of

Hi-G's quality products (transformers, solenoids, timers, printed circuit boards and others) do what they are meant to do. Keep right on working.

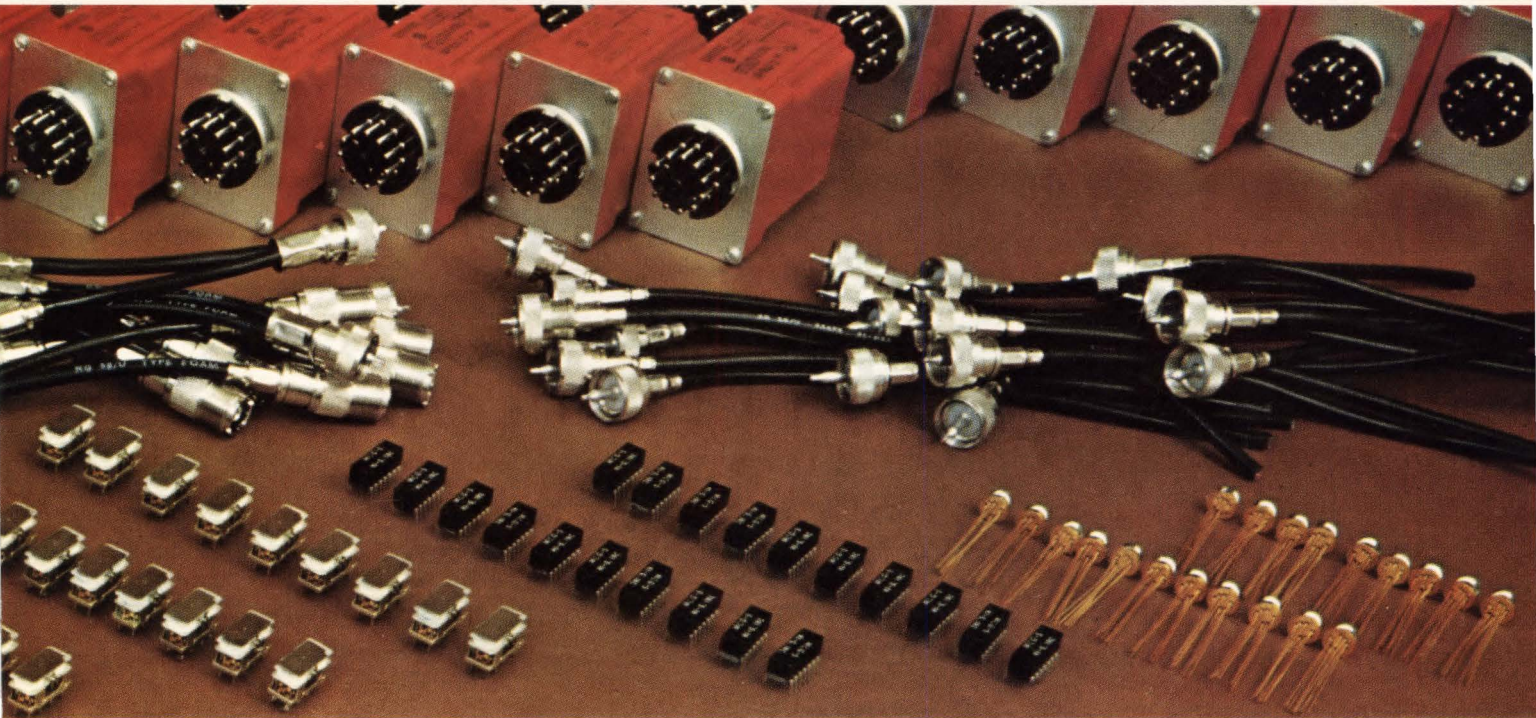

That's why Ingersoll-Rand depends on our time delay relays to preserve compressor life against insufficient oil pressure at start-up or on the job. Why the revolutionary 1978 Diesel Oldsmobile uses a Hi-G Magnetec solenoid to control the fuel supply. Why Tandy Communications Antennas/Radio Shack chooses communication connectors from Hi-G Cambridge Products for their CB radio antennas.

Our products work. And keep working. So it's fine with us if you forget them. Just remember our name. Hi-G Incorporated, 580 Spring Street, Windsor Locks, CT 06096.



Remember our name.

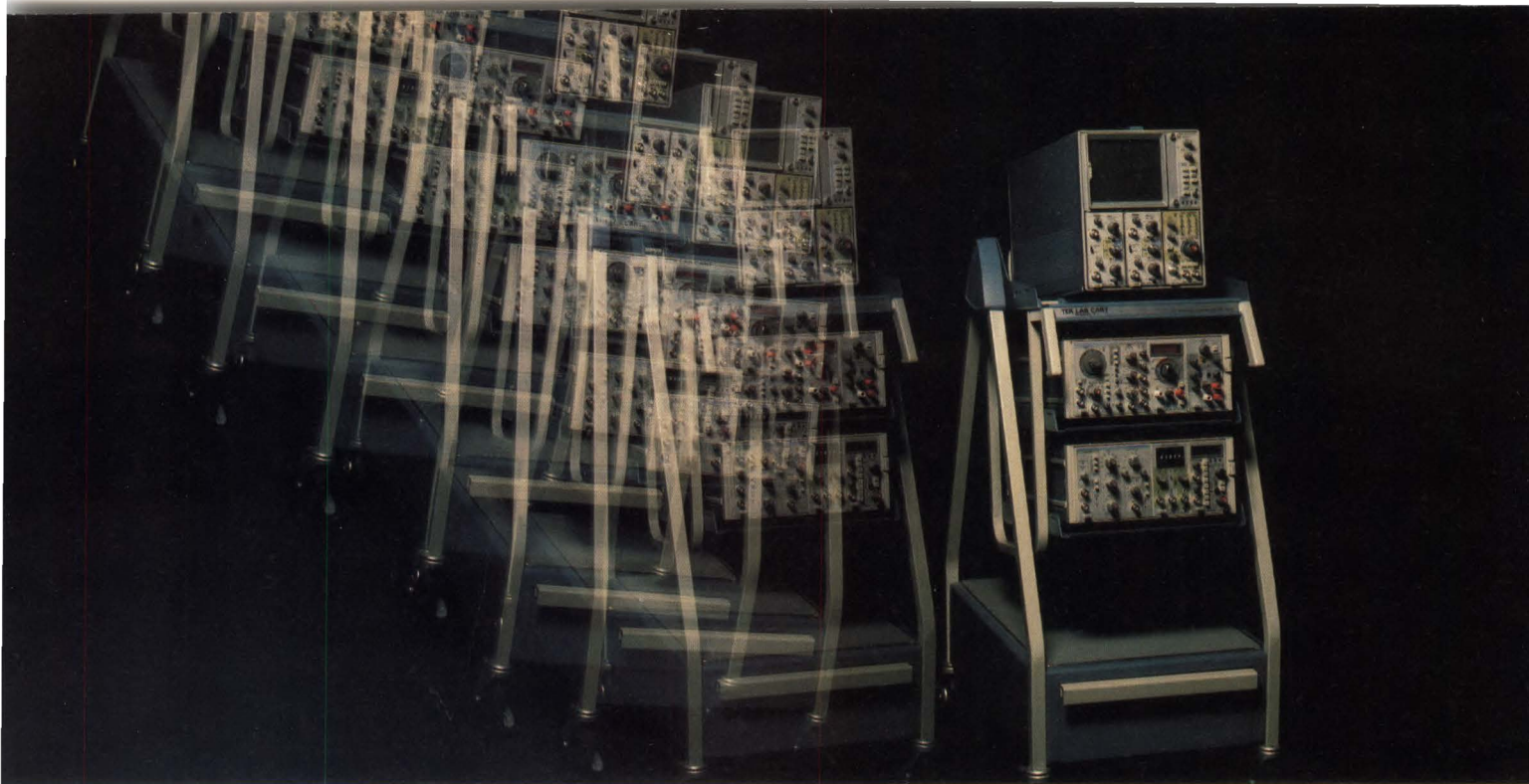

Get Rolling.

If you need test and measurement instrumentation that really moves, get behind the wheels of cart-mounted instrumentation from Tektronix.

You can load the upper tier of a Tek Model 3 Lab Cart with your Tektronix Oscilloscope, put one or two TM 500 Mainframes on the lower decks and fill them with your own configuration of TM 500 modular plug-ins:

- DMMs
- Counters
- Generators
- Amplifiers
- Power Supplies
- Plug-in Scopes
- Logic Analyzers
- Word Recognizers
- Custom Plug-ins

There are over 30 TM 500 instruments to choose from, so you can assemble a configuration that handles several specialized applications or use each individual instrument for general purposes.

Your entire instrumentation system plugs into a power distribution unit requiring a single line cord.



Your probes, accessories, additional plug-ins and documentation tuck away neatly in the bottom drawer. Now you're all set to go places.

You can travel to immovable machines and probe their inner workings . . . in one trip, not several. Or slip your mobile lab down a narrow laboratory aisle to give your bench more elbow room.

Or, zip across the production floor for a scope calibration. Tek instruments, Scopemobiles™ and Lab Carts have an internal common ground, an important feature if you get into sensitive digital circuitry.

And, if you need table top working space along with cart portability choose the TEK Rack Cart Model 7.

Like a moveable desk, the Rack Cart leaves a flat surface on top for charts, files and record keeping. And, 28" of

depth inside allows room to rackmount Tektronix instrumentation to the front or rear of the cart. A special option lets you rackmount a TM 500 six wide mainframe at an upward angle for easier usage.

With a rollabout test and measurement laboratory of Tektronix instruments, you've got a lot going for you. Flexibility. Accuracy. Configurability.

So, get rolling.

Call your Tektronix Field Engineer and ask him about taking a test stroll with the TM 500 family of modular instruments. They really go together.



TM 500 Designed for Configurability

For configurable, accurate, reliable test and measurement instrumentation, contact: Tektronix, Inc., P.O. Box 500, Beaverton, Oregon 97077, (503) 644-0161, Ext. 5283. In Europe: Tektronix Limited, P.O. Box 36, St. Peter Port, Guernsey, Channel Islands,

For Technical Data circle 24 on Reader Service Card
For Demonstration circle 25 on Reader Service Card

Tektronix
COMMITTED TO EXCELLENCE

Japanese 16-k RAMs really more reliable? Not so, says Brown

The notion that Japanese devices are inherently more reliable than corresponding American-built parts is "just plain hogwash," says J. Reese Brown of Burroughs Corp. Brown, one of the best-known memory-system device specialists, believes that the reliability spectrum of 4-k and 16-k dynamic parts is comparable for all manufacturers; **he believes that the Japanese are just careful not to ship bad parts to the U. S.** "I suspect they manufacture about the same number of poor parts as American suppliers, but are not shipping their garbage here." Brown delivered his appraisal at a meeting of Wall Street analysts held by Morgan Stanley and Co. late last month.

Still, Japanese production capacity for 16-k random-access memories continues to swell. Fujitsu Ltd. says it is turning out 175,000 devices a month and will boost that figure to 200,000 by Jan. 1. Some 40% of that total is for export. The other leading Japanese 16-k RAM producer, Nippon Electric Co., has at least that capability. These volumes are comparable to that of leading American manufacturers.

IEEE members back professional efforts, survey reveals

Even though most members of the Institute of Electrical and Electronics Engineers join to get the technical publications, **they support the institute's various plans to meet engineers' professional needs.** That is the main conclusion to be drawn from the first tabulation of a survey of members conducted this fall by the IEEE's U. S. Activities Board. Specifically, a majority of respondents favor mandatory licensing for practitioners, a legal defense fund in cases involving the code of ethics, and action against employers who ignore the guidelines for professional employment. Although a substantial majority indicated no personal awareness of age discrimination, well over half support action by the IEEE to eliminate any age discrimination that does exist.

SIA puts 1977 rise in semiconductor sales at 12.5%

Forecasts of 1977 semiconductor sales are being revised downward from the 15% to 20% increase over 1976 predicted by many at the beginning of the year. For example, the Semiconductor Industry Association says **the figure will hit \$3.86 billion, a 12.5% rise.** But Tony Davies, semiconductor analyst at the New York brokerage house of Wood Gundy Inc., is even more bearish: his forecast is 10.7%, which agrees with the estimate of analyst Ben Rosen of Morgan Stanley and Co. These figures contrast with those of some industry executives who still peg 1977 growth near 20% [*Electronics*, Nov. 24, p. 81].

3 firms offering fault analyzers for 488 interface bus

Designers putting together test systems built around the IEEE-488 standard interface bus are getting more help in debugging such systems. Hewlett-Packard Co. is offering a \$185 accessory probe for its 1602A logic-state analyzer that will help debug interface bus systems (see p. 32), and Fairchild Systems Technology, San Jose, Calif., is ready to announce a bus-fault analyzer, model 4810, a portable instrument **that can act as a talker, listener, or manual controller for the bus.** It has a 100-word memory that can store either 100 bus cycles or programmed commands for the bus when the 4810 acts as a controller. And early next year Tektronix Inc. of Beaverton, Ore., will also announce a bus-monitor attachment for its logic analyzer.

TI to have 16-k EAROM by mid-1978

Texas Instruments Inc. has started telling customers about the 16-k electrically alterable ROM that **it plans to have available in sample quantities in mid-1978**. Organized as 2,048 words by 8 bits, the read-only memory reportedly will need only three power supplies—one each for read, write, and erase—and can be accessed in about 450 ns. The firm is trying to patent its floating-gate-avalanche MOS cell structure.

TI's part will be the first American-made Famos-type electrically alterable ROM to reach the market. Nippon Electric Co. manufactures an 8-k device that is not yet being supplied in quantity, while General Instrument Corp., the largest supplier of such memories, makes only the slower nitride variety. Finally, Intel Corp., also is reported to be developing an 8-k Famos EAROM based on its ultraviolet version.

Development station from Mostek to be unbundled

Mostek Corp. will ease into the microcomputer systems business next month when it introduces a dual-floppy-disk development station for its version of Zilog Inc.'s Z-80 microprocessor. However, although it is designed for software development and debugging, all the system's constituent elements **can be purchased separately** and used by original-equipment manufacturers as building blocks for their end products.

Corning, Siemens to form U. S. optical communications firm

Corning Glass Works of Corning, N. Y., and West Germany's Siemens AG are forming a new optical-communications company. The two firms already have a joint venture (Siecor GmbH) in West Germany that manufactures optical cables using Corning waveguides. However, a U. S.-based operation is thought to be an essential element **if the two firms are to garner a healthy slice of the domestic fiber-optic communications systems market**. The new firm is expected to be based in Wilmington, N. C.

Addenda

The I^2L driver chip of the light-emitting-diode display included in Analog Devices Inc.'s AD2026 3-digit panel meter [*Electronics*, Sept. 30, 1976, p. 25] is being made available separately. **It is the first of a family of display-driver products. . . . Chip makers' interest in bubble memories continues to grow**. Intel Corp. has hired five specialists in magnetic-bubble materials and device techniques and has put a senior technologist, Gene Flath, in charge. The group reports directly to president Gordon Moore. National Semiconductor Corp. has begun a lower-level effort under technology director Pierre Lamond. And Texas Instruments Inc., the bubble leader among chip suppliers, will soon make available samples of a 262-k chip. Finally, Rockwell International Corp. has demonstrated the feasibility of a million-bit chip. All this activity bolsters the views of observers who predict a 1985 bubble memory market equaling that for dynamic RAMS. . . . Firing a shot at 16-pin designs by Texas Instruments and Fairchild, **Intel and National Semiconductor are pushing to make 18-pin packages an industry standard** for 65,535 bit charge-coupled device serial memories. The two companies have agreed that National will use Intel's tapes and working plates to make the 2464 device, which is due on the market in 1978. . . . Datapoint Corp. has come up with a new systems approach to expandable minicomputing. Called the Attached Resource Computer, Datapoint's interconnection scheme **lets the user upgrade processing power or data-retrieval capacity**.

While others promise to improve 2901 Bit-Slice performance, Signetics delivers the promise.

Introducing the Signetics 2901-1. It's 30% faster than the 2901, and distributors have it now.

When the 2901 microprocessor slice gained wide industry acceptance, Signetics began an intensive program to improve bipolar bit-slice performance. That effort has resulted in the 2901-1, the best 4-bit slice around.

Signetics 2901-1 does everything the 2901 does, but does it better and faster. With a typical cycle time of 65 nsec, the 2901-1 offers the speed and microinstruction flexibility to handle many applications.

It's great for emulating minicomputers—or for designing high-performance controllers for tape/disk systems and communications networks. And it's available today in large production volume.

Full 2901-1 Product Support.

There are many good reasons to select the Signetics bit-slice for your high-performance application. Aside from the fact that the part is very reliable, available today and 30% faster than the 2901 — Signetics provides unmatched product support.

Check the table below for some of the key ICs supporting the 2901-1. In it you'll find cost-saving LSI peripherals like our 8X02 Control Store Sequencer. Generating a 10-bit address for microprogram memory sequencing, this single IC greatly simplifies bit-slice implementation. Soon, other exciting ICs will be added to the 8X02 Sequencer family.

Signetics offers the most complete selection of Bipolar Memory ICs, including 24 PROMs and 22 RAMs. You can also choose from more than 150 standards in Schottky and Low-Power Schottky.

Microprogramming Made Easier. With our Microassembler, you get software support which makes it easier to write microprograms. This powerful design tool frees you from the task of hand-coding binary ones and zeroes. Instead, it lets you tailor the Microassembler to the specific needs of your system.

Besides producing PROM programming tapes, our Microassembler also generates listings that can serve as your microprogram's primary documentation.

Of course, the 2901-1 is fully backed by Signetics applications engineers, both at the factory and in the field. Their in-depth microprocessor knowledge can work to extend your design resources.

The Signetics 2901-1 microprocessor slice: reliable—and backed by peripheral circuits, software support and knowledgeable applications engineers. Count on it for complete design flexibility now—and in the future. Available today! For details, use the coupon below, or contact your local Signetics distributor.

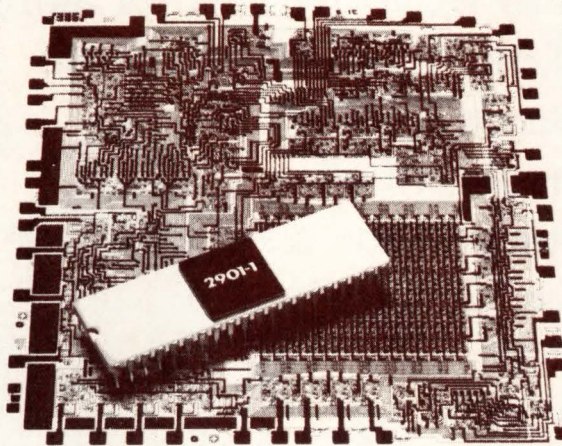

signetics

a subsidiary of U.S. Philips Corporation

Signetics Corporation
811 East Arques Avenue
Sunnyvale, California 94086
Telephone 408/739-7700

2901-1 KEY SUPPORT CIRCUITS

Available Now		Available Now	
8X02*	Control Store Sequencer	82S09*	Bipolar 64x9 RAM
82S115*	Bipolar PROM 512x8	82S16*	Bipolar 256x1 RAM
82S140/141*	Bipolar PROM 512x8	8T26A*	Inverting Bipolar Quad Bus Transceiver
82S146/147*	Bipolar PROM 512x8 (Fast)	8T28*	Non-inverting Bipolar Quad Bus Transceiver
82S136/137*	Bipolar PROM 1024x4	8T97*	Non-inverting Bipolar Hex Tri State Buffers
82S180/181*	Bipolar PROM 1024x8	8T98*	Inverting Bipolar Hex Tri State Buffers
82S184/185*	Bipolar PROM 2048x4	74S182	Look-Ahead Carry Block
82S190/191	Bipolar PROM 2048x8	3001*	Microprogram Control Unit
82S100/101*	Bipolar Field Programmable Logic Array		
82S102/103	Bipolar Field Programmable Gate Array		

*Second source available

To: Signetics Information Services, 811 E. Arques Ave., P.O. Box 9052, Sunnyvale, CA 94086

- Please send 2901-1 data file.
 My need is urgent: have an applications engineer phone me.

() _____ ext. _____

Name _____ Title _____

Company _____ Division _____

Address _____ MS _____

City _____ State _____ Zip _____

Please also send literature for the following 2901-1 key support circuits: EM128

"Siliconix VMOS are down. Bipolars'

"VMOS power FETs, introduced by Siliconix in 1975, have always been better than bipolars—more rugged, more reliable, faster and simpler. Today, we're lowering our prices as we move further along the learning curve, and our economical plastic package brings superior VMOS technology within reach of all designers. At 96¢ apiece,* the new TO-202s will replace bipolars in a broad range of power applications, particularly in interfacing with computers and in telecommunications."

*VN46AF in quantities of 100-999

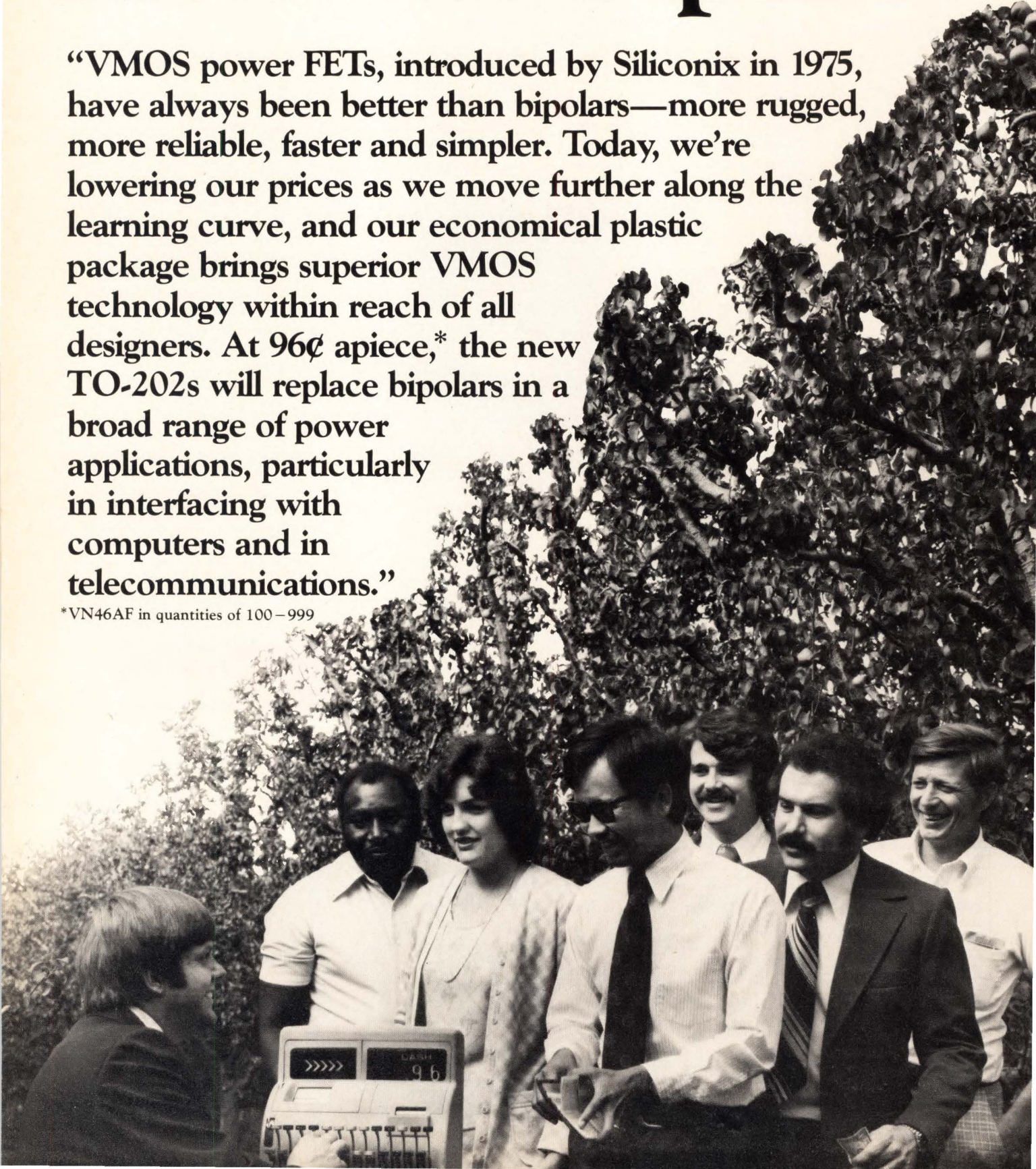

power FET prices time is up."

Siliconix VMOS power FETs in plastic:
TO-202 package

Part #	$V_{DS(on)}$ ($I_D=1$ Amp)	Price:1-29	31-99	100-999
VN46AF 40	3.0V	\$1.33	\$1.12	\$0.96
VN66AF 60	3.0V	\$1.39	\$1.16	\$1.00
VN88AF 80	4.0V	\$1.54	\$1.29	\$1.10

All three devices are guaranteed over the temperature range of -55°C to 150°C ; their maximum power dissipation is 12.5 watts, and their current rating is 2.0 amperes.

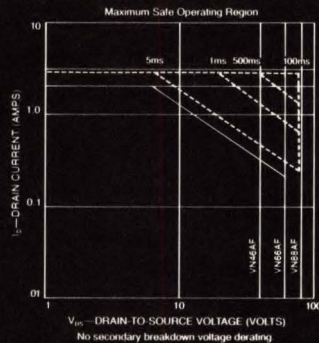

Other VMOS power FETs introduced by Siliconix are also available:

Part #	Package	P_{DISS}	V_{DS} ($I_D=1.0$ Amps)
2N6656	TO-3	25W	35
2N6657	TO-3	25W	60
2N6658	TO-3	25W	90
2N6659	TO-39	6.25W	35
2N6660	TO-39	6.25W	60
2N6661	TO-39	6.25W	90

"Until 1975, MOS field-effect transistors (FETs) were restricted to small-signal, low-power applications. To control high currents, designers used bipolar devices. Then Siliconix, using Vertical MOS technology, introduced the VMOS power FET — combining the reliability of FETs with the power of bipolars.

"Today, Siliconix' new plastic TO-202 package means that VMOS power FETs are not only superior to bipolars in performance, but also competitive with them in price. They'll simplify designs and reduce component count in most systems because they eliminate pre-amplifiers, driver transistors, and external protective circuitry required for bipolars. And they can be inserted by machine, a time- and cost-saving advantage in high volume production.

"Anyone who has designed with bipolars knows the failures that can result from thermal runaway, secondary breakdown and current hogging. You don't have to worry about these problems with VMOS power FETs; their positive temperature coefficient eliminates hot-spotting and provides uniform current density, making them fail-safe. Consider how this inherent reliability will reduce your system interruptions and maintenance costs. And VMOS power FETs are faster than bipolars in switching operations — as much as 100 times faster. With all these advantages packed into the low-cost TO-202, you'll be able to eliminate bipolars' problems completely from many system designs.

"The high input impedance of VMOS and its threshold voltage range allow it to interface directly with CMOS, MOS and TTL logic families. And the VMOS power FET is the only interface device with a switching time comparable to that of ECL, so it will interface with a simple

level shift — without losing speed. These features make the TO-202s ideal for data processing applications: computer peripherals, micro- and minicomputer systems, and process control equipment. They're also ideal for use in telecommunications: as telephone relay replacements, Touch-Tone muting switches, audio amplifiers, central office systems and analog switches.

"Our new line of VMOS power FETs in plastic may mean the end of the line for bipolars. We want you to discover for yourself how they can improve system design, so use the coupon to send for our detailed brochure. To order parts, contact any of our franchised distributors: Alliance, Century, Components Plus, Future, Hamilton/Avnet, Industrial Components Inc., Pioneer Standard, Pioneer Washington, Quality Components, Semiconductor Specialists, Wilshire, Wyle/Elmar, Wyle/Liberty, or RAE."

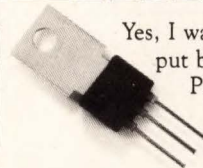

Yes, I want to find out for myself how Siliconix put bipolars on the list of endangered species. Please send me your brochure.

Name/title _____
 Company _____
 Address _____
 City/State/Zip _____

Siliconix Incorporated,
 2201 Laurelwood Road, Santa Clara, CA 95054,
 (408) 246-8000.

EL 12/5/77

 Siliconix

RF TRANSFORMERS

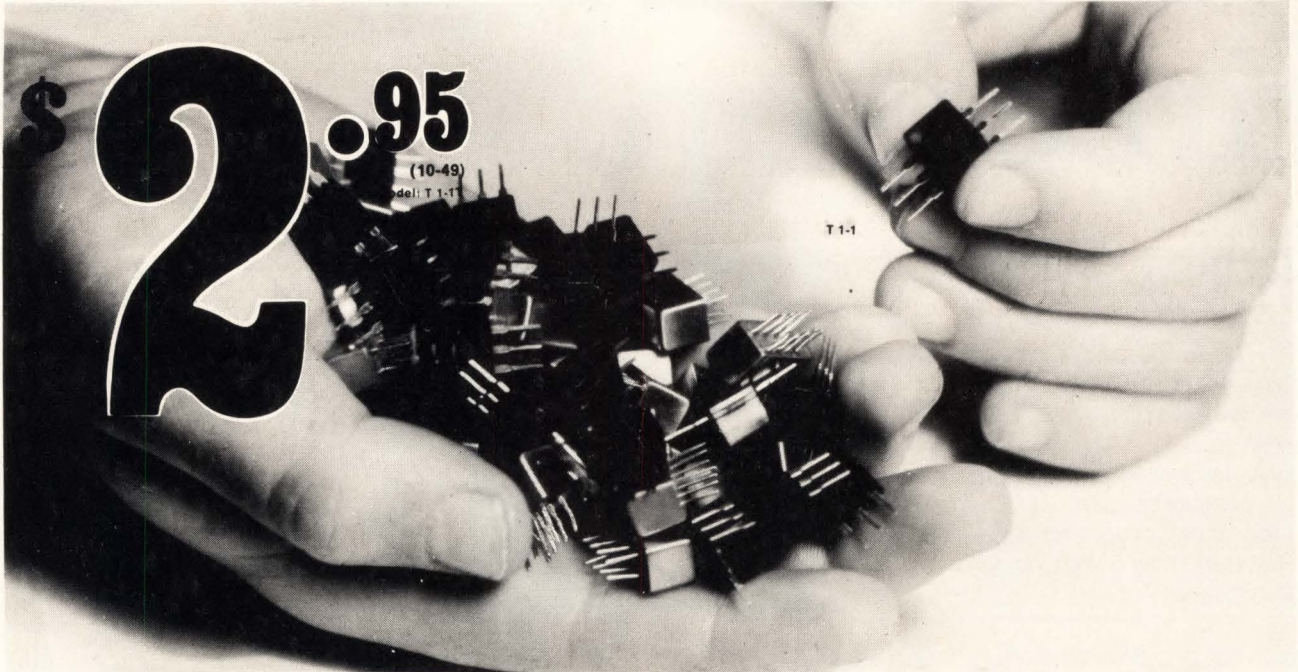

Have it your way! 36 models to choose from, 10KHz-800MHz

It costs less to buy Mini-Circuits wideband RF transformers. The T-series (plastic case) and TMO series (hermetically sealed metal case) RF transformers

operate with impedance levels from 12.5 ohms to 800 ohms and have low insertion loss, 0.5 dB typ. High reliability is associated with every transformer. Every

production run is 100% tested, and every unit must pass our rigid inspection and high quality standards. Of course, our one-year guarantee applies to these units.

DC ISOLATED PRIMARY & SECONDARY							DC ISOLATED PRIMARY & SECONDARY CENTER-TAP SECONDARY							
Model	TMO 1-1	TMO 1.5-1	TMO 2.5-6	TMO 4-6	TMO 9-1	TMO 16-1	Model	TMO 1-1T	TMO 2-1T	TMO 2.5-6T	TMO 3-1T	TMO 4-1	TMO5-1T	TMO 13-1T
Metal Case	T 1-1	T 1.5-1	T 2.5-6	T 4-6	T 9-1	T 16-1	Metal Case	T 1-1T	T 2-1T	T 2.5-6T	T 3-1T	T 4-1	T 5-1T	T 13-1T
Plastic Case	T 1-1	T 1.5-1	T 2.5-6	T 4-6	T 9-1	T 16-1	Plastic Case	T 1-1T	T 2-1T	T 2.5-6T	T 3-1T	T 4-1	T 5-1T	T 13-1T
Freq. Range, MHz	.15-400	.1-300	.01-100	.02-200	.15-200	.3-120	Freq. Range, MHz	.05-200	.07-200	.01-100	.05-250	.2-350	.3-300	.3-120
Impedance Ratio	1	1.5	2.5	4	9	16	Impedance Ratio	1	2	2.5	3	4	5	13
Max. Insertion Loss	MHz	MHz	MHz	MHz	MHz	MHz	Max. Insertion Loss	MHz	MHz	MHz	MHz	MHz	MHz	MHz
3 dB	.15-400	.1-300	.01-100	.02-200	.15-200	.3-120	3 dB	.05-200	.07-200	.01-100	.05-250	.2-350	.3-300	.3-120
2 dB	.35-200	.2-150	.02-50	.05-150	.3-150	.7-80	2 dB	.08-150	.1-100	.02-50	.1-200	.35-300	.6-200	.7-80
1 dB	2-50	.5-80	.05-20	1-100	2-40	5-20	1 dB	.2-80	.5-50	.05-20	.5-70	2-100	5-100	5-20
Price, Model TMO	\$4.95	\$6.25	\$5.95	\$5.95	\$5.45	\$5.95	Price (10-49)							
(10-49) Model T	\$2.95	\$3.95	\$3.95	\$3.95	\$3.45	\$3.95	Model TMO	\$5.95	\$6.25	\$6.25	\$5.95	\$4.95	\$6.25	\$6.25
							Model T	\$3.95	\$4.25	\$4.25	\$3.95	\$2.95	\$4.25	\$4.25

UNBALANCED PRIMARY & SECONDARY					
Model	TMO 2-1	TMO 3-1	TMO 4-2	TMO 8-1	TMO 14-1
Metal Case	T 2-1	T 3-1	T 4-2	T 8-1	T 14-1
Plastic Case	T 2-1	T 3-1	T 4-2	T 8-1	T 14-1
Freq. Range, MHz	.015-600	.5-800	.5-600	.15-250	.2-150
Impedance Ratio	2	3	4	8	14
Max. Insertion Loss	MHz	MHz	MHz	MHz	MHz
3 dB	.015-600	.5-800	.5-600	.15-250	.2-150
2 dB	.02-400	2-400	.5-600	.25-200	5-100
1 dB	.05-200		2-250	2-100	2-50
Price, Model TMO	\$5.45	\$6.25	\$5.45	\$5.45	\$6.25
(10-49) Model T	\$3.45	\$4.25	\$3.45	\$3.45	\$4.25

Designers Kit Available

(TK-1) — 2 transformers of each type T1-1, T2-1, T4-1, T9-1, T16-1 **\$32.00**
 (TMK-2) — 2 transformers of each type TMO-1, TMO2-1, TMO4-1, TMO9-1, TMO16-1 **\$49.50**

WE'VE GROWN

Customer acceptance of our products has been so overwhelming, we've been forced to move to larger facilities — THANKS.

International Representatives: □ **AFRICA:** Afitra (PTY) Ltd. P.O. Box 9813, Johannesburg 2000, S. Africa □ **AUSTRALIA:** General Electronic Services, 99 Alexander Street, New South Wales, Australia 2065 □ **ENGLAND:** Dale Electronics, Dale House, Wharf Road, Frimley Green, Camberley Surrey □ **EASTERN CANADA:** B.D. Hummel, 2224 Maynard Avenue, Utica, NY 13502 (315) 736-7821 □ **FRANCE:** S.C.I.E. - D.I.M.E.S. 31 Rue George - Sand 91120 Palaiseau, France □ **GERMANY, AUSTRIA, SWITZERLAND, DENMARK:** Industrial Electronics GMBH 6000 Frankfurt/Main Klüberstrasse 14 West Germany □ **INDIA:** Gaekwar Enterprise, Kama Mahal, M.L. Dananukar Marg, Bombay 400 026 India □ **ISRAEL:** Vectronics, Ltd. 69 Gordon Street, Tel-Aviv Israel □ **NETHERLANDS, BELGIUM, LUXEMBOURG:** Cormex Veldweg II, Hattem, Holland

OUR NEW ADDRESS AND PHONE NO. IS

Mini-Circuits
MINI-CIRCUITS LABORATORY

A Division of Scientific Components Corp

2625 East 14th Street Brooklyn, New York 11235 (212) 769-0200
 Domestic and International Telex 125460 International Telex 620156

□ **NORWAY:** Datamatik AS, Ostensjovien 62, Oslo 6, Norway □ **SINGAPORE & MALAYSIA:** Electronics Trading Co. (PTE) Ltd. 87 Bukit Timah Road, Singapore 9, Malay Peninsula □ **SWEDEN:** Integerad Elektronik AB Box 43, S-18251, Djursholm, Sweden

U.S. Distributors: □ **NORTHERN CALIFORNIA:** PENN-STOCK Co. Foothill Office Center, 105 Fremont Avenue, Los Altos, CA 94022 (415) 948-6533 □ **SOUTHERN CALIFORNIA, ARIZONA:** Crown Electronics, 11440 Collins Street, No. Hollywood, CA 91601 (213) 877-3550
NEW YORK: MICROWAVE DISTRIBUTORS COMPANY
 61 Mall Drive, Commack, N.Y. 11725 516 543-4776

Circle 30 on reader service card

Big bubble chips point the way to low-cost memories

Rockwell is developing 1-megabit bubble memory chips—but production is at least three years off

For designers of mass memory systems, magnetic-bubble chips still cannot compete on a cost-per-bit basis with magnetic disks and tapes. That is why Rockwell International's design of a 1-megabit bubble chip is important, since a capacity that big promises to make bubbles cost-competitive.

"The significance of our megabit chip is that it verifies production economies," explains Rockwell's John L. Archer. As manager of applied magnetics in the Electronics Research division, Anaheim, Calif., he spearheads the firm's bubble memory work.

Moving force. Agreeing with Archer is Steve Cottrell, senior analyst of Creative Strategies Inc., a market research firm in San Jose, Calif. In a recent study on bubble memories (and semiconductors), Cottrell sees the availability of megabit chips as the moving force behind sales growth—to \$53 million in 1980 and \$81 million in 1981. His figures are low compared to other estimates, because, as he sees it, only the megabit chip and its millicent-per-bit potential will start people buying in volume.

Cottrell predicts very little growth through 1978 or until 250- and 500-kilobit chips become available. Applications will be in relatively slow, high-density storage, he points out, for such things as operational pro-

Megabit bubble memory at Bell also

Bell Laboratories, where the bubble memory was invented, also has built bubble memory chips containing over 1 million bits of data. This was done to explore the feasibility of producing 1-megabit devices in large volume. The bubbles on the 1-megabit devices have submicrometer features, a 1.7- μm diameter, and an 8- μm period.

Magnetic-bubble chips with up to 68,121 bits of information are in production at the Western Electric Co. in Reading, Pa., and pilot production has begun on 272,484-bit bubble memory chips. The 68-k chips are being tested in a system that plays recorded messages at a Michigan Bell Telephone facility [*Electronics*, Feb. 17, p. 38]; production systems will be available next spring. A fully serial arrangement of 3- μm -diameter bubbles in a 16- μm period, with a 2- μm finest feature, is used in the chips. The 272-k devices use major-and-minor-loop technology and have 1.7- μm -diameter bubbles each in an 8- μm period, with a 1- μm finest feature.

"Our present objective is to fabricate 1-megabit bubble memory chips with a 4- μm period," says Joseph E. Geusic, head of Bell's Magnetics department in Murray Hill, N. J. At the 1-megabit/4- μm level, he asserts, "it looks like bubbles will be competitive with large electromechanical disk-file storage systems."

grams for minicomputers and microcomputers, or in point-of-sale terminals where the bubbles' lack of volatility is a big plus.

In developing a fully operational major-and-minor-loop 1-megabit chip during a program begun in February, "we might have scooped a few people," says Archer. The 10-by-9.5-millimeter chip has a density of 1.6×10^6 bits per square centimeter, 10 times greater than Rockwell's earlier 102,400-bit chips [*Electronics*, Sept. 30, 1976, p. 29]. The new megabit device uses the same technology as the smaller version: magnetic garnet film grown on a gadolinium-gallium-garnet substrate. It has been operated successfully at frequencies up to 300 kilohertz over a temperature range of -25°C to 75°C .

The megabit device "could sell eventually for as little as 10 milli-

cents per bit," says Archer, but he adds that availability is at least several years off. "A 262-k chip actually could be a better bet for the near term," he says, since it would have a potentially low price and about twice the speed. "Access time would be better because the loop size would be half that of the megabit chip, and the block length would be 256 bits, against 512 bits for the megabit," he notes.

Potential users looking at bubbles for systems operating at 100 to 200 kHz, the clock rate of the rotating magnetic field, "are more interested in performance than in cost right now," says the Rockwell engineer. He has, however, nothing to say on whether Rockwell is working on a 262-kilobit chip.

Doubled resolution. For the 1-mb chip, the Anaheim division was able to double resolution of standard

Electronics review

400-mil-field photolithographic masks, thereby quadrupling bit densities. "With photoresolution of 1 micrometer, we are designing bubble diameters of 1.8 μm for the megabit chip," he explains. This is much more demanding than processing 4- μm -diameter bubbles for a 262-k chip, he points out. Much of the high-resolution work was associated with Rockwell's program to build a solid-state bubble memory recorder for the National Aeronautics and Space Administration [*Electronics*, Jan. 6, 1977, p. 31].

In the so-called field-access bubble memories being built by Rockwell, Bell Laboratories, and others, "it's a designer's rule of thumb to separate bubbles by four to five times their diameter so their magnetic properties won't interfere," Archer points out. Thus, Rockwell's megabit chip has 8- μm cells for its

bubbles with their 1- μm diameters.

Bubble memory prices are evidently a ticklish question for manufacturers, possibly because so far the memories have been available only in such small quantities. For example, Texas Instruments Inc. is mum on its earlier volume production projection of 40 to 50 millicents per bit for its 92,304-bit memory device introduced last year [*Electronics*, Sept. 30, 1976, p. 29].

"We get more conservative as we get closer to reality," says a TI spokesman. He notes a \$200-per-chip price in quantities of less than 10. Rockwell's own eight 100,000-bit chip systems, offered at \$5,000 each, are no longer available.

After perfecting the 1-Mb device, Rockwell expects the next density level will yield a 4-Mb chip, a jump that will require X-ray or electron-beam lithography. □

Instruments

Hewlett-Packard develops probe for tracking problems on interface bus

The logic-state analyzer, with its combination of hexadecimal and binary displays, has proven to be an ideal tool for troubleshooting microprocessor-based systems. Now, Hewlett-Packard Co. is applying it elsewhere—to monitor the digital transactions on the IEEE-488 interface bus, the standard for connecting instruments into a test system.

"We have designed a finger pointer," says Charles Small, project engineer at HP's Colorado Springs, Colo., division, of the new 10051A test probe. An accessory for the company's 1602A logic state analyzer, it is a circuit pod built onto a 16-wire flat cable that plugs into the interface bus connector.

"Although the bus makes it easy to connect instruments from different manufacturers into a system, it's often difficult to find which instruments have failed when there's a breakdown," Small explains. "For example, data may be lost if one instrument stops sending too quickly

or another instrument prematurely closes off the conversation. Our new test probe looks at sequences of commands flowing on the bus, and from these sequences we can identify the instrument causing problems."

The \$185 10051A joins the 59401A bus system analyzer in HP's arsenal of bus development tools. The 59401A stores 32 characters for monitoring the bus lines. It can also take over control of the bus, whereas the smaller test probe is simply a passive bus watcher.

Other options. Until now, a designer could use either the 59401A to debug a system or single-step a calculator controller through the program, checking signals with an oscilloscope. HP extends the logic state analyzer to troubleshoot a system built around a digital bus. But as memory and microprocessor costs decrease, designers of programmed logic systems will likely produce specialized instruments aimed at debugging the 488 bus.

Fairchild System Technology is, for example, readying a new bus-fault analyzer (see p. 25). Other instruments may also soon appear, and at prices below HP's two-year-old \$2,700 59401A, and, perhaps, even below the \$1,995 price of the \$1,800 1602A and its 10051A probe.

Analyzer signals. HP's new probe contains logic circuitry to decode and convert the commands on the bus to signals compatible with the analyzer. This unit then stores the signals and translates them for alphanumeric display. The probe also triggers the analyzer to store information on the basis of commands, data, or a combination of the two. As many as 64 16-bit characters can be stored.

The probe can, for example, track down the cause of an abnormal handshake—the standard series of signals that indicate that one instrument is ready to send while another is ready to receive. This is done by setting the logic analyzer to trigger on the first bus transaction involving a data byte following an abnormal handshake.

Analyst. Test probe for troubleshooting IEEE 488 bus works with HP's logic state analyzer. Data sequences, displayed on readout, indicate when system malfunctions.



The operator can then step through the command and data sequences occurring before and after the abnormal handshake. These are stored and displayed until the cause of the problem is determined. □

Memory

Micro-Bit still pushes that solid-state tube

For a while there were three, but now there is just one. The only organization still pushing to develop a solid-state memory in a vacuum tube that combines the capacity of rotating magnetic disks and drums with the speed of semiconductors is Micro-Bit Corp. of Lexington, Mass.

In contrast, General Electric Co. is looking to sell its technology, even though it demonstrated the technical feasibility of its beam-addressed metal-oxide-semiconductor memory system earlier this year. Stanford Research Institute, for its part, ceased following up its development of a similar system when funding from the military stopped.

Micro-Bit, however, is "very optimistic," a spokesman says, about prospects for its version of a beam-addressable memory system [*Electronics*, May 1, 1975, p. 104]. The development recently of a two-stage prototype tube with 128 million bits of memory in a single glass envelope feeds this optimism.

Micro-Bit, a privately held firm owned principally by computer manufacturers Control Data and Amdahl and by Exxon Enterprises and Sprague Electric, will "be ready to ship production systems with over 200 million bytes of memory capacity and less than 20-microsecond access time by late 1979," says marketing manager Robert Beese. "Before the end of this year, we'll have a demonstration system running with 4 million bytes of capacity," he adds.

Two-foot tube. The smaller system will be built around an earlier single-stage deflection tube about 2 inches in diameter and 24 in. long. It has a

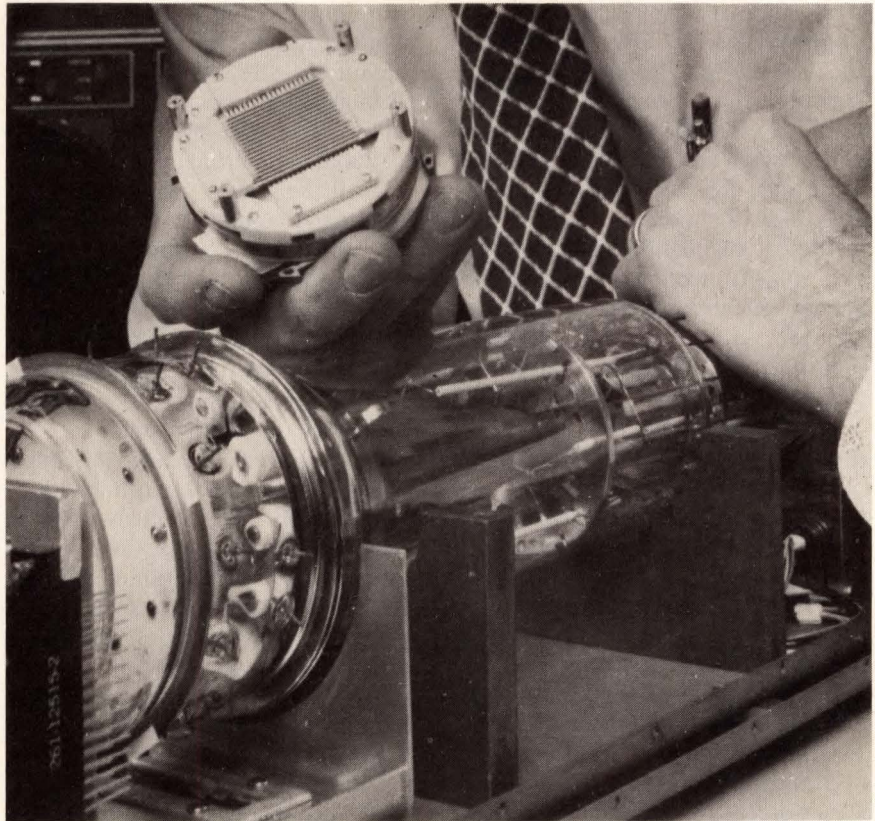

Beamos. Once it is placed inside a GE memory tube, the array of tiny lenses focuses electron beams onto information storage sites contained in a metal-oxide-semiconductor target.

memory capacity of 4 megabits. As do the other tubes, it stores data as small areas of charge contained in an oxide layer grown on a silicon substrate. An electron beam both writes the data and reads it out of this metal oxide semiconductor.

Micro-Bit's demonstration system will use eight of these data tubes, but the final system toward which the firm is aiming will use its new 128-million-bit tubes. Similar to the 32-megabit tubes developed by GE, each has an array of lenses as a second stage that allows the tube's electron beam to be directed simultaneously at multiple targets on the MOS memory. The Micro-Bit tube has a 32-by-32 array (1,024 lenses), compared with a 17-by-17 array (289 lenses) in the GE tube.

As for General Electric, it has quietly decided to discontinue what it called its Beamos program begun in 1971. "It was a business and not a research decision," says Virgil L. Stout, research and development manager in the Electronics Science

and Engineering sector of GE's R&D center in Schenectady, N. Y.

"To get the mileage that can be achieved, it's best to build a computer around [the memory]—or at least a memory system," explains Laddie L. Stahl, operations manager of electronic systems programs at GE. To do so requires a "tremendous range of skills in areas such as solid-state physics, electro-optics, and circuit detection. General Electric went out of the computer business, and we decided in early summer not to go into memory systems as a business."

The GE tubes had an access time of 30 μ s, or three times longer than a 100-megabit tube the firm was in the final stages of developing when the program was discontinued. Since summer, however, the company has been quietly making the rounds trying to sell or license the technology. A GE team made a formal presentation to Sperry Univac in Blue Bell, Pa., and had discussions with Honeywell Information Systems Inc. of Waltham, Mass. So far, however,

it has not met with success.

Army likes it. One organization that hopes GE finds a buyer or licensee is the Army. "We spent several hundred thousand dollars, perhaps one tenth of what GE spent, in sponsoring their work in beam-addressed memories," says Irving Reingold, chief of the beam, plasma, and display technical area in the Army's Electronics Technology and Devices Laboratory at Fort Monmouth, N. J. "We're still interested. But with our present limited monies and priorities, we have to put the program on the shelf for a while."

GE's work "was successful for high-density computers," says Reingold. "It is also an economically viable approach for high-density memory applications. While it's not competitive with semiconductor memory at lower densities of about 10^6 or 10^7 bits, it is very competitive with other memory technologies at 10^{12} and 10^{14} bits."

Stanford Research Institute in Palo Alto, Calif., funded by the Air Force's Avionics Laboratory, had a working model more than three years ago [*Electronics*, Oct. 3, 1974, p. 44], but the Air Force ended the project over a year ago and says it has no interest in the technology. □

Filters

Tunable chip uses programmable CCD

Just over the horizon for charge-coupled devices is the programmability associated with the microcomputer. An early example is a transversal filter—a key element in data-processing and communications systems—whose characteristics can

be tailored by data in a programmable read-only memory. Moreover, the filter, called the R5602 by its developer, Reticon Corp. of Sunnyvale, Calif., is the first commercially available monolithic unit.

Until now, the only monolithic transversal filters for analog signal processors were custom large-scale integrated CCDs designed by suppliers like General Electric, Texas Instruments, Westinghouse, and Hughes Aircraft. Often, however, the filtering is handled by blocks of discrete analog components.

Tuning levels. Reticon has produced a 16-pin dual in-line device that can be programmed—that is, tuned—at three levels. At the factory, it can be programmed much like a ROM via a single metal mask into one of four types of filters, two low-pass and two bandpass, each in narrow- and broadband versions. In addition, each of these types can be further customized—that is, its characteristic curve can be tailored—on the basis of information supplied by the user.

Finally, the user can electronically tune the device from 1 to 100 kilohertz by changing its input clock, and therefore the sampling frequency. In a low-pass filter, this tunes the edge of the passband; in the bandpass filter, it changes the center frequency. By comparison, most discrete and hybrid filters are only slightly tunable mechanically.

The R5602 is a 64-element bucket-brigade device, says Reticon's president, John Rado, making use of the fundamental metal-oxide-semiconductor structure as a capacitor. Its input circuitry samples an analog signal, converts it into a charge packet, and then transfers the sample down an analog delay line under control of a two-phase clock applied

to the electrodes. Filtering is done by splitting the electrodes of the bucket-brigade elements in a variety of ratios to form capacitors for the filter's tap-weight function.

As the sampled signal moves down the line, it induces a current in these capacitors proportional to the product of the tap weight and the signal amplitude. The differences between the signals from each pair of electrodes are then summed for reconstructing the desired weighting function; this is done in an external differential amplifier. With the clock driver and control circuitry on chip, the only other external device is an input sampling clock.

High rolloff. A feature of the 64-tap split-electrode device is its high transition, or roll-off, rate. Typically, these are about 200 decibels per octave, going as high as 400 db per octave in some cases. According to Rado, these are extraordinarily high values when compared with those of conventional eight-pole filters, which have only a 48-to-50-dB-per-octave value and take up a whole circuit board. "What you get with the R5602, then, is a monolithic device that is the equivalent of a 32- or 64-pole filter," says Charles Gopen, Reticon's marketing manager. "That's something that requires several printed-circuit boards of hybrids and discretos now."

A typical application is in generating single-sideband signals, where one sideband is rejected and the other passed, within very tight tolerances. Another application is in data-acquisition systems, between the transducer and the analog-to-digital converter, to band-limit the input signal without distortion.

The device operates with sampling rates of 1 megahertz and a rejection in the stopband of about 50 dB. Price

Powerful. Programmable bucket-brigade filter from Reticon does the job of several boards full of components in one monolithic device.

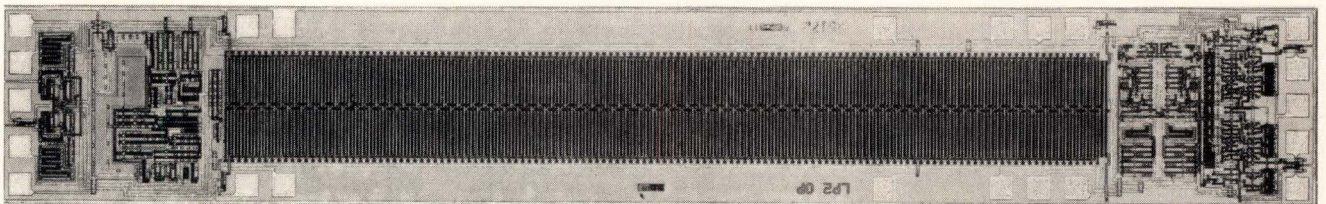

SCIENCE/SCOPE

A new short-range missile seeker technology -- based on an M-band frequency of 94 GHz -- has been shown to penetrate adverse weather better than electro-optical or infrared seekers. It also delivers better resolution than does conventional radar. A prototype 94 GHz seeker, developed by Hughes under joint Air Force-Navy funding, has undergone laboratory and tower testing in active and passive modes against tanks and trucks. Helicopter captive flight tests have been completed at the Naval Weapons Center, China Lake, California.

Results indicate that the M-band provides a better match of resolution and penetrating characteristics for use in fog, rain, heavy clouds, battlefield smoke or dust than any other portion of the spectrum. Though still developmental, the 94 GHz seeker is projected as a small, relatively inexpensive, terminal guidance unit for short-range missiles, guided projectiles or longer range weapons equipped with a mid-course guidance system.

Negotiations are underway for two additional satellite programs for meteorological service to the U.S. and Japanese Space Agencies. NASA has selected Hughes to build, test and deliver three Geostationary Operational Environmental Satellites (GOES-D, E and F). The heart of the spacecraft in this series will be a Visible Infrared Spin-Scan Radiometer Atmospheric Sounder (VAS) to produce day and night cloud cover photos of an Earth-portion from a geostationary orbit plus vertical temperature soundings of various atmospheric levels. The instrumentation payload also will contain a Space Environment Monitoring system consisting of three separate sensors designed to monitor solar emission activities.

Hughes Industrial Products Division in Southern California has opportunities for Electronic Engineers, Physicists, Technicians and Glassblowers with experience in CRT's, laser applications, microelectronics, infrared detectors, silicon crystal growth, industrial automation, image and display products, and liquid crystal displays. Please send resume to: Hughes Aircraft Company, Professional Employment, 6155 El Camino Real, Carlsbad, CA 92008.

New laser instrument application with forty-millionths-of-an-inch accuracy foretells a revolution in manufacturing standards. Such unprecedented precision was produced in Hughes radar fabrication shop through a linkup of a laser interferometer (used to measure distances) with a computer-controlled Ekstrom Carlson machine, designed to contour and profile aircraft radar antenna quads.

Automatically compensating for changes in temperature and air pressure, the interferometer lets a machinist position a part within one/ten-thousandths of an inch -- double the machine's original accuracy. In this unique application, accurate measurements to 0.000040-inch have been recorded. Changes in height, depth and width can be monitored and corrected to the virtual elimination of error. Quality control inspectors can cross-check findings against their standard measurement techniques. And the increased accuracy is seen as reducing the need for total inspection of parts after fabrication and the number of rework parts.

Creating a new world with electronics

HUGHES

HUGHES AIRCRAFT COMPANY

is about \$10 each in quantities of 1,000. There is a one-time programming fee, varying from \$5,500 to \$9,500, for customizing the monolithic filter via the metal mask.

The only major semiconductor firm with a line of transversal filters is National Semiconductor Corp., Santa Clara, Calif. It has a family of pc-board and hybrid products and is reported to be developing a monolithic filter, probably using the CCD approach that relies on an MOS capacitor to store information. □

Photovoltaics

Spectrolab nixes role in low-cost program

In an important defection from the U. S. government's low-cost silicon solar array program, Spectrolab Inc. has declined to participate in the terrestrial solar cell program. The Sylmar, Calif., subsidiary of Hughes Aircraft Co. late last month dropped out of negotiations for the program's next big step—a buy of 190 kilowatts of solar cells. The firm is a major supplier of photovoltaic cells for space use.

Weak profits. “A weakening profit potential for flat-plate solar electric-power modules prompted de-emphasizing the business,” is the way Gary Wrench, president of Spectrolab explains the company's decision.

Although Wrench is not saying it directly, he apparently feels that he cannot make money at the price levels quoted during the negotiations. Motorola Semiconductor in Scottsdale, Ariz., a recent entry in the terrestrial business, says it is quoting prices of \$12 to \$15 per watt. This is well enough below the per watt prices of \$15 and up that had been anticipated by Spectrolab. In the past, others have voiced the opinion that the goal of \$1 and \$2 per watt by 1980 was too ambitious [*Electronics*, Sept. 29, p. 58].

The Energy Research and Development Administration has awarded five contracts worth \$2.9 million to

buy 190 kilowatts of solar cells. The contractors are Solarex Corp., Solar Power Corp., Sensor Technology, Motorola Semiconductor, and Arco Solar Corp. Some 40 kw of cells to have been built by Spectrolab were divided among the five. An extra 10 kw is being held “in reserve,” says a spokesman at Jet Propulsion Laboratory, Pasadena, Calif., which administers the program for ERDA.

Spectrolab, a principal supplier in earlier Government solar cell buys, would have had to expand production facilities to build the cells. Instead, Wrench wants to concentrate on such things as improving the cell's conversion efficiency, reducing material costs, and building parts for concentrator systems. Sales of solar cells for space are actually getting better, he asserts.

Good competitor. Robert H. Willis, president of Solar Power Corp., North Billerica, Mass., says he is sorry to see Spectrolab drop out of the buy “because they're good, honest competitors. They're scientifically knowledgeable, and that kind of competition is always welcome.”

One winner in the procurement believes the inclusion of Motorola hurt not only Spectrolab but “maybe all of us, because of what we see Motorola's game is—market share and low price.” Low prices promised by the Government may be causing potential commercial customers to delay their purchases, thinks another source close to the low-cost project. “The market in photovoltaics has really gone to pot in the last 3 to 4 months,” he says. □

Packaging & production

Sandia circuits survive 300°C

Designing circuits to operate at +125°C, the upper end of the military temperature range, would be considered a hot enough problem by most engineers. Imagine, then, the predicament faced by designers at Sandia Laboratories in Albuquerque, N. M., who had to build analog

hybrid circuits to operate for 1,000 hours at up to +300°C.

But they are doing it, and with commercially available components at that. “There's no magic to creating 300°C hybrids,” says John D. McBrayer, a semiconductor device engineer at the facility, which specializes in research and development projects for the Department of Energy and the military. “Anyone can do it with careful circuit design and pretested components. In fact, in the future we expect to be able to make the same components operate to even higher temperatures.”

McBrayer and his colleagues, D. W. Palmer and C. R. Hickam, are designing their hybrids for low-voltage circuitry in measurement sensors lowered deep into geothermal wells. But their approach can be applied in circuitry used in any high-temperature environment.

Device limits. The severest limit the designers faced was on their choice of active devices. Obviously, not everything works at 300°C, and of the discrete and integrated-circuit devices they tested only junction and metal-oxide-semiconductor field-effect transistors were found suitable. Gallium-arsenide and discrete bipolar devices, metal-emitter-semiconductor FETS, and even ceramic vacuum tubes were not.

With the FETS—and both n- and p-channel chips are being used—the Sandia engineers found the transfer functions of the devices change very little over the +25° to +300°C range. MOS devices, on the other hand, show a slow degradation. Discrete bipolar devices have excessive leakage currents, while the common-junction isolation of bipolar ICs breaks down at the high temperatures. As for gallium-arsenide devices, McBrayer found their lives shortened by internal oscillations.

For the passive components, conductors, resistors, and small-value capacitors are screen printed on conventional 96% alumina substrates. Of several conductor inks tested, only a fritless gold material, DuPont 9910, had adequate bond-pull strength over time. For the capacitor dielectric, DuPont 8299

How to get green LED lamps for half the usual price.

If you order red lamps, we'll give you from 7½% to 12% green for the same low price as red. A limited-time offer to introduce you to our new guaranteed-brightness GaP green lamps. Just look at these prices:

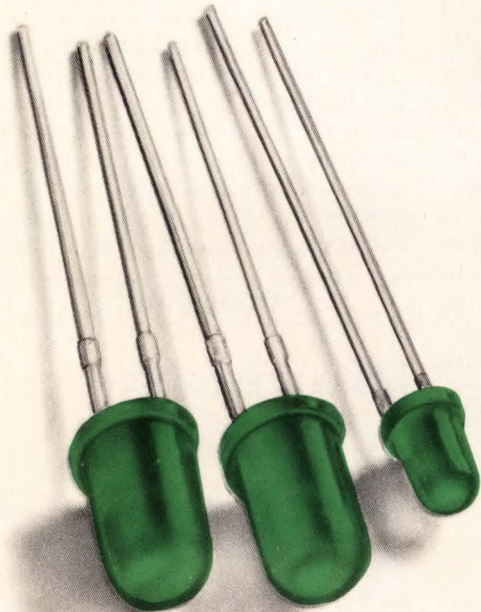

Lamp size	Color	Litronix Part No.	Competitive equivalent	Litronix price in quantities of:				
				10K	25K	50K	100K	250K
T-1	Red Green	RL-209A GL-211	TIL-209A TIL-211	10¢	9.7¢	9.5¢	9¢	8.5¢
T-1-¾	Red Green	RL-4403A GL-4950	HP5082-4403 HP5082-4950	10.5¢	10.2¢	10¢	9.5¢	9¢
Percent green in total quantity ordered →				7½%	8½%	10%	11%	12%

Orders, of course, must specify a single delivery date.

Litronix recently affiliated with Siemens to bring you the broadest selection of optoelectronics available anywhere. Phone your local distributor or contact Litronix at 19000 Homestead Road, Cupertino, Calif. 95014. Phone (408) 257-7910.

**From the New Giant
in optoelectronics**

litronix

An Affiliate of Siemens.

Circle 37 on reader service card

Electronics review

was chosen. For the resistive inks, Sandia found several manufacturers of inks with temperature coefficient specified for 25°C to 300°C.

Costly tests. Perhaps the costliest element in designing the circuits was the time required for screening and pretesting the semiconductors. Placed in temperature chambers at 300°C, the field-effect devices were monitored for parameters like gain transconductance and leakage.

Probing the chips during these tests was a problem, because conventional semiconductor test gear could not be used at the high temperature, McBrayer points out. The solution was to bond the FET chips to a bumped film carrier made by Pactel Corp., Westlake Village, Calif. This carrier, conventionally used by the semiconductor industry to handle chips, consists of electrically gold-plated copper patterns deposited on a reel of polyimide film. Pactel then evaporates 2-mil-square aluminum-coated nickel bumps on the gold-plated fingers of the patterns.

The chips' aluminum-plated contacts are ultrasonically bonded to these bumps. This gives an aluminum-to-aluminum interface between chip and carrier and avoids the risk of purple plague inherent in a gold-to-aluminum interface. After testing, each frame of the film carrier with its chip is ultrasonically bonded to the hybrid substrate. □

Business

Wema's chief seeks Washington impact

"I'm the first Wema executive from 'back East,'" quips J. Jan Collmer, and the lanky Texan's election last month to a one-year term as Wema board chairman underscores the organization's geographic diversity, now that it is no longer confined to West Coast electronics members. "The Wema acronym has ceased to have any specific meaning, though it still tends to be associated with our former name, Western Electronic Manufacturers Association," Coll-

mer says. "There's even consideration being given to changing it."

Already by far the largest of the electronic industries' trade associations, with its more than 1,000 member and associate firms, Wema is intent on further expanding both the number and geographic base of its members. "That expansion is important in improving our strength in dealing with Washington," explains Collmer, 43, who is also president of Varo Inc., a Garland, Texas, manufacturer of high-power semiconductors for consumer and industrial applications and night-vision components and equipment. Last year, Varo, which Collmer joined in 1960, had \$75 million in sales. At Wema, he succeeds Kenneth Oshman, president of Rolm Corp., Santa Clara, Calif.

Washington is where Wema, with a \$1.7 million annual budget that is up from last year's \$1 million, wants to make its mark. During Collmer's tenure it will focus its efforts against the Administration's tax reform proposals and against legislation extending the Government's ability to renegotiate contracts.

This year, Wema was primarily responsible for the defeat of a bill authored by Rep. Joseph G. Minish (Dem., N. J.) that tried to extend the life of the Renegotiation Board. The board was set up during the Korean War to renegotiate Government contracts that have resulted in "excess profits." It has no authority over contracts awarded after September 1976, but it is still working on a four-year backlog. The bill would also allow renegotiation by product line, instead of by company.

Vigilance needed. "We expect to see the renegotiation bill surface again, and we'll continue battling it, because improved profitability is the key incentive for cost reduction," Collmer says. "If those profits are renegotiated back to the Government, there's no motivation to cost-reduce our products, and many of our members have testified that they would refuse to do business with the Government under such an arrangement."

Wema's second great concern lies



Focused. Tax reform legislation and the Renegotiation Board are high on the list of J. Jan Collmer's concerns at Wema.

in the area of capital formation. "The Administration's tax reform proposals are extremely prejudiced against the formation of capital," Collmer says, and his association has set up a task force to gather data that shows this.

"At worst, Wema would like to see the retention of the existing capital gains tax structure," he argues, "but preferably, we'd like to see capital gains taxes reduced, particularly for the high growth areas that require new investment."

Wema will voice its position on other issues as well—in support of free trade, for example. "We would hate to see the U. S. develop a protectionist approach against the Japanese," Collmer says. The association will also increase its services to member firms: it has formed a workers' compensation insurance company in California that will be expanded to other states, and it is looking at other forms of group insurance and benefits, he says. □

Consumer

Matsushita shows its new video disk

The video disk sweepstakes gained an important entry late last month. The Japanese, who have previously been indifferent to disks while sew-

Get Smart.

ADDS *Regent* · Smart for the price of Dumb.

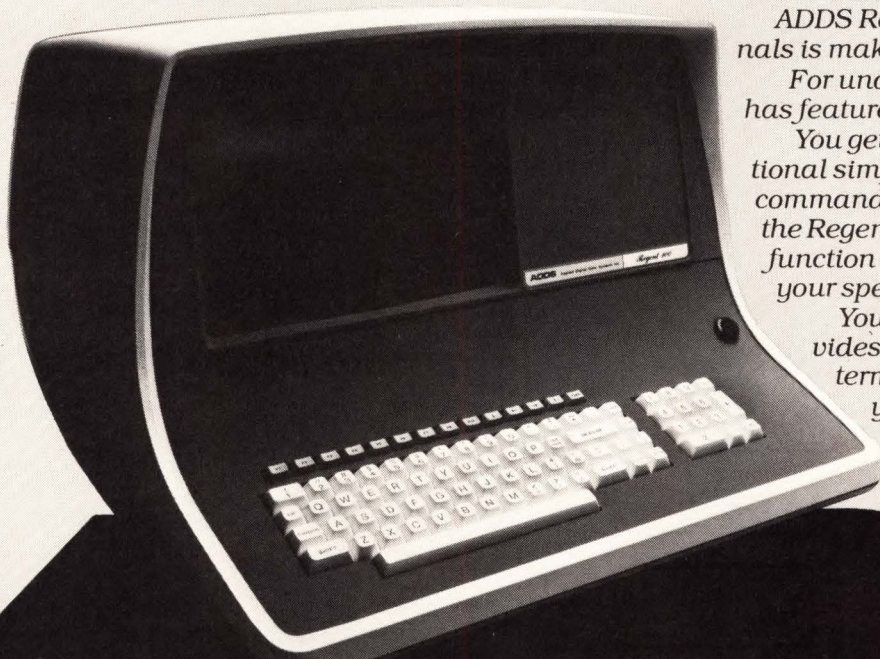

Time was, if a man bought a Dumb terminal, he was considered pretty smart. Times change.

ADDS Regent family of Smart terminals is making Dumb look dumb.

For under \$1000* our Regent 100 has features no smart man can resist.

You get cursor controls for operational simplicity and extensive remote commands that make it easy to control the Regent from the computer. Optional function keys customize Regent to your specific application.

You get a Status Line that provides current information on the terminal's operating status. And, you get visual highlights such as blinking, zero intensity, half intensity, underline and reverse video.

You also get self diagnostics.

In other words, you get Smart. Or Smarter: Our Regent 200 has everything our 100 has plus buffered transmission, auxiliary port and editing options.

You can't get a whole lot more.

Get Smart. Get ADDS.

Quality, Reliability and Integrity. It all adds up to ADDS.

*In moderate quantity.

ADDS Applied Digital
Data Systems Inc.
100 Marcus Blvd., Hauppauge,
New York 11787 516-231-5400
Dept. 250

Name _____

Firm _____ Title _____

Address _____

City _____ State _____

Phone _____

Circle 39 on reader service card

TOTAL FREQUENCY CONTROL

FROM **ERIE**

HIGH FREQUENCY AT CRYSTALS

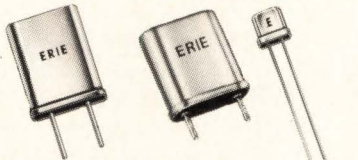

Erie AT Crystals are used over the frequency spectrum from 950 kHz to 200 MHz. Low temperature coefficient, extremely high Q, economical. Used in TCXO and VCXO oscillators, temperature controlled and, non-controlled oscillators, and filter applications. All size cans.

LOW FREQUENCY CRYSTALS



Low frequency crystals are available from 1 kHz to 1MHz in a broad variety of crystal holders and mounting configurations. Erie is a leading source for all types of high quality, Low Frequency Crystals.

CRYSTAL OSCILLATORS



Erie offers a broad range of economical as well as highly sophisticated Crystal Oscillators. These small size oscillators are available in a wide range of frequencies. Hermetically sealed crystals assure long term stability. Design assistance available.

CRYSTAL FILTERS

Erie quartz crystal filters are specified for use in communications receivers . . . as well as for radar, sonar and space applications.



Write for brochure describing Erie Crystals, Filters, Oscillators and Ovens.

ERIE

ERIE FREQUENCY CONTROL DIV. OF
ERIE TECHNOLOGICAL PRODUCTS
Carlisle, Pa. 17013
717/249-2232

Electronics review

News briefs

Raytheon buying maker of word-processing systems

Raytheon Co. is acquiring Lexitron Corp. of Chatsworth, Calif., for about \$15 million. A manufacturer of stand-alone word-processing systems, Lexitron will become an operating unit of Raytheon Data Systems Co. of Norwood, Mass., which produces minicomputers, data terminals, and telecommunications systems. Lexitron president Richard O. Baily will continue in his present post. Lexitron's sales are estimated at \$21 million for 1977, when the 6-year-old firm hopes for its first-ever profitable year.

IBM researchers check out bubble lattice memory

A bubble lattice memory was tested successfully at IBM Corp.'s San Jose, Calif. Research Laboratory in a program to gain fundamental understanding of this new technology. The 1,024-bit device, built in a film of yttrium iron garnet, contains all the elements for reading and writing needed in a complete storage device. The lattice memory stores information as differences in the magnetic structure within the thin tubular walls of the bubbles; conventional field-access bubble devices rely on the presence or absence of the entire bubble to indicate 1s and 0s. Thus, lattice bubbles can be packed closer together, offering higher-density storage.

Suit filed to bar Cobilt's projection printer

Perkin-Elmer Corp. of Norwalk, Conn., is suing Computervision Corp., charging that a projection printer to be introduced next year infringes on patents relating to P-E's Micralign projection mask-alignment system, the industry leader. The suit, filed in San Francisco, seeks money damages and an injunction against production and sale of the CA-3000 projection printer by Computervision's Cobilt division, Santa Clara, Calif. The patents at issue cover the scanning annular-field optical system that enables the high-resolution performance essential to microcircuit production.

ing up the burgeoning consumer market for video recorders using magnetic tape, are now in the race.

Matsushita Electric Industrial Co. announced in Tokyo a disk system that returns to relatively simple technology—disks stamped from polyvinyl chloride, the same method and the same cheap material used for ordinary long-playing phonograph records. Carrying the LP record technique further, the system, called Visc II by Matsushita, relies on an extremely fine diamond needle driving a piezoelectric transducer to reproduce information contained in grooves.

The company has eschewed more exotic techniques like the laser readout still being developed by the team of Philips-MCA or the capacitance pickup of RCA [*Electronics*, April 3, 1975, p. 72]. Instead, Visc II resembles the developmental Teldec system of Telefunken and Decca, which also relies on a mechanical stylus to read the crests and valleys

recorded on specially coated disks.

But Matsushita has gone beyond Teldec. Its disk need not be specially coated, turns at 450 revolutions per minute instead of Teldec's 1,800 rpm, and will play for one hour on each side, compared with Teldec's 10 minutes.

Except for the diamond stylus and pickup cartridge, Matsushita says all components for a player are readily available and could be produced for between \$480 and \$600. Video tape systems are now list-priced in the U. S. at about \$1,000. Groove depth on the 300-millimeter-diameter disk is about 1 μ m, with the undulations that carry information at the bottom of each groove about 0.1 μ m high. The Philips MCA 300-mm disks spin at 1,800 rpm, but their pitch is only 1.6 μ m yielding a half-hour playing time. In comparison, LP records spin at 33 $\frac{1}{3}$ rpm and have a groove pitch of about 100 μ m.

Spacing between hills on the Matsushita disk, corresponding to

MICROCOMPUTER USERS.

Single Board Real Time Analog I/O Systems
 ...Widest Selection, Fast Turnaround, Lowest PRICES

**GUARANTEED
 5 DAY DELIVERY**

Single Board Analog I/O Systems		DT1161	DT1162	DEC LSI-11	DT1184	DT1185	DT1186	DT1167	DT1151	DT1141	DT1142	DT1144	DT1155	INTEL SBC-80 SERIES	DT1841	DT1842	DT1843	DT1131	DT1132	COMPUTER AUTOMATION LSI 2 & 3	DT1133	DT1134	DT1122	DT1123	NATIONAL IMP & PACE	DT1191	DT1195	PCS SUPERPAC	DT1181	DT1182	DT1184	ZILOG MCB SERIES (Z-80)	DT1185			
Analog Inputs	16 channels																																			
	32 channels																																			
	64 channels																																			
	10mV to 10V range																																			
	0 to 10V, ±10V, ±5V ranges																																			
Analog Outputs	1 to 5V (4 to 20mA) range																																			
	8 bit resolution																																			
	12 bit resolution																																			
	2 channels																																			
	4 channels																																			
Features	8 channels																																			
	0 to 10V, ±10V, ±5V ranges																																			
	4 to 20mA range																																			
	point plotting																																			
	8 bit resolution																																			
12 bit resolution																																				
programmable gain																																				
100KHz throughput																																				
program I/O & interrupt																																				
DMA interface																																				
power required: +5V only																																				

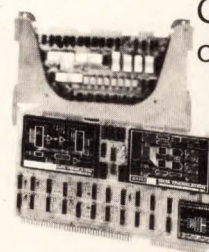
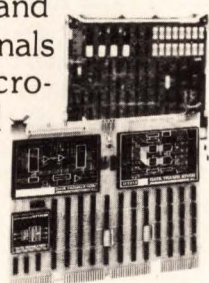

These single board systems provide the most cost effective and fastest way to get analog signals into and out of your micro-computer. Just plug in the board and hook-up your analog signals. Get a headstart on solving your system's problems without the headaches of designing an analog front end.

Concentrate on the software and other key system requirements... and let us take care of your analog problems. We've seen them all and solved them in these systems...no mysteries, no tweaking.

Prices are surprisingly low, with 8-bit models starting at \$295 and 12-bit models at \$395 both in OEM quantity.

Send for full technical data or call us.

DATA TRANSLATION
INC
 4 Strathmore Rd., Natick MA 01760
 (617) 655-5300 Telex 94-8474

Circle 41 on reader service card

SALES OFFICES: AZ, Scottsdale 602-994-5400; CA, Cupertino 408-257-5131; CA, Santa Ana 714-540-3245; CO, Denver 303-837-1247; IA, Cedar Rapids 319-362-0503; KS, Prairie Village 913-649-4000; MD, Fulton 301-953-3724; MA, Natick 617-655-5300; MO, St. Louis 314-997-1515; NM, Albuquerque 505-292-1212; NM, Las Cruces 505-523-0601; NY, Rochester 716-334-2445; UT, Salt Lake City 801-466-6522; VA, Arlington 703-527-3262; WA, Bellevue 206-455-1246.



MITEL

WINNER OF THE 1977 IEEE TOP CANADIAN COMPONENT AWARD

MITEL'S MD4301 CMOS/LSI DETECTOR/TIMER

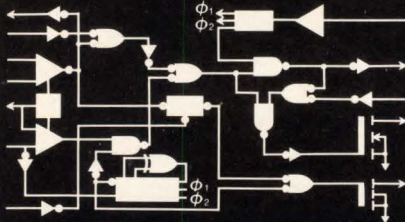

- 6.5 V to 12.5 V Operation
- Fet Input Amplifiers
- Low-Battery Warning
- Led DRIVER—Over 20 mA
- Standby Current—Less than 25 μ A
- On-Chip DRIVER—Over 300 mA
- Audio Oscillator—1 Hz to 20 KHz
- DC or AC Output Signals

IDEAL FOR

- Smoke/Fire Detectors—Ion Chamber and Photoelectric Types.
- Gas Detectors—Natural, Propane, Silane, Etc.
- Temperature Detectors—Freezers, Stoves, Furnaces, Environment.
- Pressure Detectors—Weights, Forces, Strains, Movements.
- Timers/Controllers—Burn-In Units, Sprayers, Heaters, Etc.

For more information write or phone.

18 AIRPORT BLVD.
BROMONT, QUEBEC, CANADA
JOE 1L0
(514) 534-2321
TLX.: 05-267474



MITEL

Semiconductor

Circle 42 on reader service card

Electronics review

the recorded wavelength, is about $0.5 \mu\text{m}$ at a maximum recording frequency of 10 megahertz. The video luminance signal is recorded as a frequency-modulated carrier with a synchronized tip frequency of 4.3 MHz and a white peak frequency of 6.3 MHz. The company declines to reveal how the color subcarrier and the two 20,000-kilohertz-bandwidth audio channels are recorded. The cartridge is carried on a radial trolley with zero tracking error, and a mechanism keeps the cartridge synchronized with the spiral groove while maintaining low tracking force.

Matsushita, which already supplies RCA, Sylvania, Magnavox, and General Electric with video tape recorder systems, will license its disk system. It did not indicate when it would enter production itself. First, it must line up disk manufacturers, as well as program material. \square

IEEE

USAB to trim professional action

The U.S. Activities Board, which oversees professional programs of the Institute of Electrical and Electronics Engineers, learned late last month who would head it next year—and he has a lot of IEEE members worried. The reason: 58-year-old Bruno Weinschel, founder and president of Weinschel Engineering Co., a manufacturer of microwave calibration equipment in Gaithersburg, Md., has concentrated almost solely on technical activities during his 32 years in the institute. He has been little involved with the tumultuous efforts within the institute to fashion professional and career-oriented programs.

Tightened procedures. "I have one ambition as head of USAB," says Weinschel, who will carry the title of IEEE vice president. "I want to heal the rifts and tighten up the operating procedures. I think I can do it because I have the confidence of the technical side of the institute." \square

It is this emphasis of Weinschel, who was nominated by the board of directors and elected at the annual IEEE Assembly, that worries proponents of greater concern for the socioeconomic affairs of members. Their complaint is that Weinschel has little empathy for members' career aspirations.

They fear he will scuttle advocacy programs such as lobbying in Washington for a pending bill that would safeguard engineers against wage-busting practices in service-contract companies. They also expect Weinschel will downplay the IEEE's stepping in as *amicus curiae* in legal cases that involve engineers in such matters as questions of ethics and age discrimination. "I don't know a lot about some of these programs, but my feeling is we have spent too much time and resources considering the number of engineers involved," Weinschel says. "We may stay with it at a much lower level."

The anticipation of just such a response has a former member of USAB commenting, "The fox is not only guarding the chicken coop, he is inside getting ready for a feast." But Weinschel denies he is intent on "cutting the legs off USAB," pointing out that he favors a broad range of programs. These include establishing portable pensions, stronger employment guidelines, a clearcut code of ethics, and improving engineers' patent rights.

Project orientation. Weinschel hopes to set up projects-oriented committees that would operate like IEEE standards committees with bare-bones budgets and travel paid by interested companies when necessary. He is also intent on developing technical white papers underscoring trends that will directly affect engineering employment.

One example is a long-range study of the computer industry to learn if U.S. manufacturers are "5 or 6 years away from what just happened to Zenith in color tv." This type of study would analyze the economy, the threat posed by the Japanese computer industry, and the R&D spending necessary to maintain America's superiority. \square

In September we said:

**You
like
our
EPROM.**

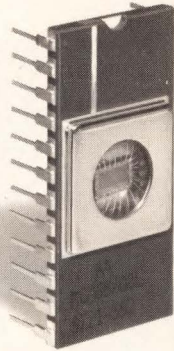

**You'll
love this
new PROM.**

It's our new MCM2708P, the first inexpensive 2708-type PROM. It's inexpensive because it's the first ever in a plastic package.

Use the one-time programmable MCM2708P. It's exactly plug-in compatible with 2708 EPROMs. Program it just as you would program the EPROM, and save dollars by the handful.

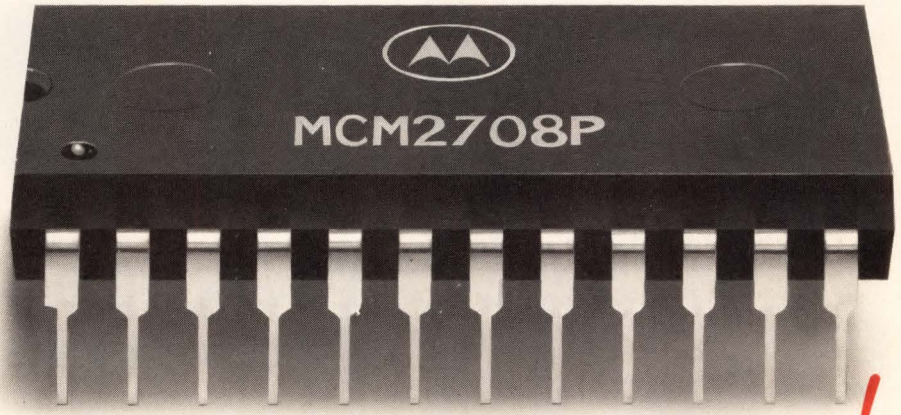

Now, *lower* *Better!*
You'll love our new EPROM/PROM prices, too.

Get your MCM2708P data sheet from Motorola Semiconductor Products Inc., P.O. Box 20912, Phoenix, AZ 85036, or circle the reader service number.

*Frit-Seal
Available Soon!*

Device Number	Function	100-999 Price
MCM2708P	8K PROM	\$14.20 <i>\$7.90</i>
MCM2708L	8K EPROM	\$21.00 <i>\$13.50</i>

Contact your authorized Motorola distributor or any Motorola sales office for the MCM2708L and the new MCM2708P.



MOTOROLA Semiconductors

The mind to imagine... the skill to do.

**If this ad doesn't
don't know what we
will.**

**WHEN
RAN
THERE'S A
THEY DIDN'T**

A/D Converters
Accuracy: 0° to +70°C
Power Supplies Required
External Active Components Required
System Cost
Price @ 100 pcs.

No spec	1 count
2	1 (+5V)
4	2
Higher	0
\$9.97	Yes

The LAE36 Reference... plus the other external components you might need for your panel meters and digital

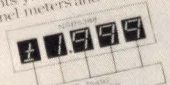

DVM BLOCK DIAGRAM
multimeters, Regulators, Digit Drivers... NSB & NSN Series seven Segment displays... and Resistor Arrays.

accuracy (0.025%...
And the bipolar ADD2501...
A complete converter on a chip...
including the reference. All it needs are a few passive external elements and a display. \$7.95.
The new monolithic A/D Converters from National...
Hello more reliability.
Hello less cost.
Goodbye Motorola.

National introduces its answer to the Motorola MC14433. The ADD3501 3 1/2-digit A/D converter... manufactured using National's standard MM74C Series CMOS process.
As you can see from the chart, it offers more performance and requires fewer external components than Motorola.
Fewer components means lower system cost and greater reliability.
The ADD3501 uses pulse width modulation as a conversion technique, rather than

dual slope. Which means...
entirely better temperature...
long term stability.
And our out-of-range...
condition is "OFL," not just...
The ADD3501 is...
available now from National...
distributors. Pick up a...
samples and give us a...

One-stop shopping for digital panel meter and multi-meter components. Other ways to convert you.

IN FACT, THERE ARE SEVERAL.

In fact, there are several.

A/D CONVERTERS

	Motorola MC14433	National ADD3501	Intersil 7106/7
Accuracy: 0° to +70°C	No Spec	± 1 count max	± 1 count max
Power Supplies Required:	2	1 (+5V)	1 (+5V to +9V)
Additional IC's required:	4	2	0
LCD Compatible	No	No	Yes
System Cost:	Higher	Lower	Lowest
Price @ 100 pcs:	\$9.97	\$9.95	\$9.25
All Display drives on chip:	No	No	Yes
Floating Differential Input:	No	No	Yes
Floating Reference:	No	No	Yes

DELIVERY. If price and performance aren't your only criteria, think about this: Intersil is shipping the ICL 7106 and 7107. Now.

ONE CHIP. LED or LCD. Intersil offers you one chip simplicity. Now. And a whole family of

A/D, D/A converters that mean you can stop beating the bushes for your converter needs.

DRIVES LCD DISPLAYS. Requires no active external components. Includes back plane drive circuitry.

ARIZONA—Liberty Electronics, Kierulff Electronics. CALIFORNIA—Elmar Electronics, Intermark Electronics Inc., Kierulff Electronics, Liberty Electronics, Schweber Electronics. COLORADO—Century Electronics, Elmar Electronics, Kierulff Electronics, Schweber Electronics. FLORIDA—Arrow Electronics, Diplomat/Southland, Inc., Schweber

Electronics. GEORGIA—Arrow Electronics, Schweber Electronics. ILLINOIS—Schweber Electronics, Kierulff Electronics. INDIANA—Advent Electronics, Inc., Sheridan Associates. MARYLAND—Arrow Electronics, Schweber Electronics. MASSACHUSETTS—Arrow Electronics, Kierulff Electronics, Schweber Electronics. MICHIGAN—Schweber Electronics, Sheridan Sales. MINNESOTA—Arrow

Electronics, Schweber Electronics. MISSOURI—LCOMP. NEW JERSEY—Arrow Electronics, Diplomat IPC, Corp., Schweber Electronics. NEW HAMPSHIRE—Arrow Electronics. NEW MEXICO—Century Electronics. NEW YORK—Arrow Electronics, Components Plus, Harvey Federal Electronics, Schweber Electronics. NORTH CAROLINA—RESCO. OHIO—Arrow Electronics, Schweber

NATIONAL THIS AD, REASON MENTION US.

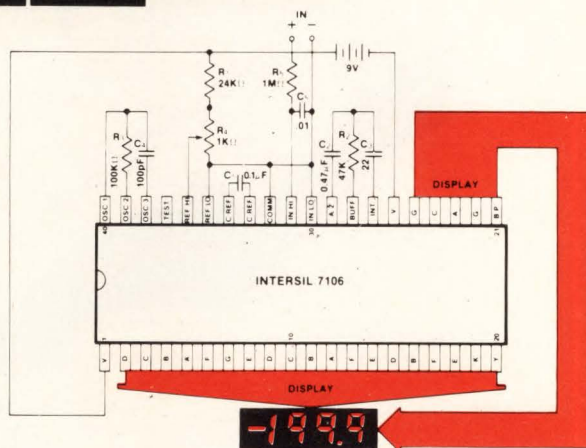

TRUE DUAL SLOPE. The ICL 7106 and 7107 are true dual slope...rather than pulse width modulation or digital auto-zero. Then, consider Intersil's better noise rejection and true integration of input signal. And they can handle differential inputs from 200mV to 2.000V full scale.

4-1/2 DIGIT ACCURACY. Other Intersil IC, 8052A/7103A, offer 20,000 count accuracy with immediate availability.

THEIR AD SAID: "The new monolithic A/D from National. Hello reliability. Hello less cost. Goodbye Motorola"

OUR AD SAYS: Goodbye National.

HERE'S HOW WE MAKE IT STICK: Prototype a working DPM for either \$24.95 (LED), or, \$29.95 (LCD). With our prototyping kits. Just send your check or P.O. to your local Intersil Distributor with the coupon below.



INTERSIL

10710 North Tantau Avenue
Cupertino, California 95014, U.S.A.
Telephone: (408) 996-5000

You're talking tough. Here's your chance to prove it. Send me:

- Prototyping Kit #ICL 7106EV (LCD) \$29.95 complete.
 - Prototyping Kit #ICL 7107EV (LED) \$24.95 complete.
 - I believe you, send your App. Note: #A016, A017, A018, A023 and 7106/7107 D.S.
- I've enclosed a check, Purchase Order.

Name _____
Company _____
Address _____
City _____ State _____ Zip _____
Country _____

(If outside the United States)

Electronics, Sheridan Associates, Sheridan Sales.
OKLAHOMA - Component Specialties.
PENNSYLVANIA - Schweber Electronics,
Sheridan Sales. TEXAS - Component Special-
ties, Schweber Electronics. UTAH - Century
Electronics. WASHINGTON - Kierulff Elec-
tronics, Liberty Electronics. WISCONSIN -
Arrow Electronics. CANADA - CESCO,
L.A.E. Ind. Elect. Ltd., Zentronics Ltd.

Circle 45 on reader service card

California Improved* Octal Buffers

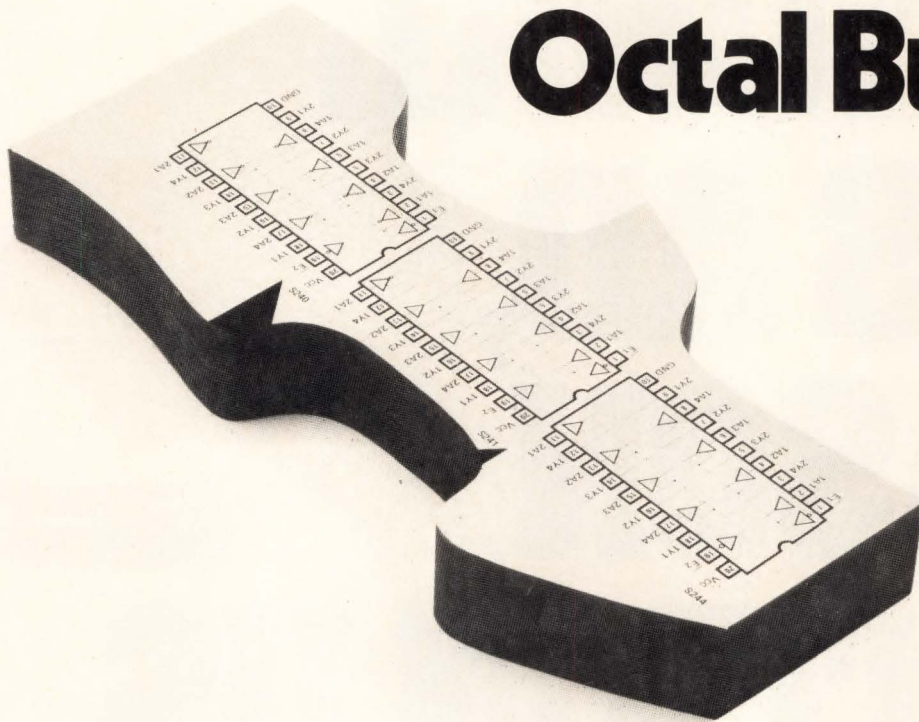

The 20 pin Octal Interface Family

Monolithic Memories introduces another member of a growing family of 20 pin Octal Microprocessor Interface devices.

Now you can get Octal Latches, Registers, and Buffers from the World Leader in LSI Bipolar memory. Our years of experience in producing LSI Bipolar memories are your guarantee of high quality devices, on time deliveries and competitive pricing.

As the preferred second source, we give you everything that T.I. does, but it doesn't stop there.

Check the chart and see the improvements we've made. Look at all of our options. See if we shouldn't be your first choice for Octal Interface.

For more information phone, TWX or write.

TYPE	California Improved*	PART NUMBER	
		S	
LATCH		SN54/74S373	
	32 mA I _{OL}	57/67S373	
	INVERTING OUTPUTS	57/67S380	
	INVERTING OUTPUTS AND 32 mA I _{OL}	57/67S382	
REGISTER		SN54/74S374	
	32 mA I _{OL}	57/67S374	
	INVERTING OUTPUTS	57/67S376	
	INVERTING OUTPUTS AND 32 mA I _{OL}	57/67S378	
BUFFER		SN54/74S240	
		SN54/74S241	WATCH THIS SPACE
	WATCH THIS SPACE	SN54/74S244	WATCH THIS SPACE

Europe
Monolithic Memories, GmbH
Mauerkircherstr. 4
8000 Munich 80
West Germany
Tel: (089) 982601, 02, 03, 04
Telex: (841) 524385

United States
Monolithic Memories, Inc.
1165 East Arques Avenue
Sunnyvale, CA 94086
Tel: (408) 739-3535
TWX: 910-339-9229

Far East
MMI Japan KK
Parkside-Flat Bldg.
4-2-2, Sendagaya Shibuya-Ku
Tokyo 151, Japan
Tel: (3) 403-9061
Telex: (781) 26364

**We deliver more
Octal Interface
than anybody
except T.I.**

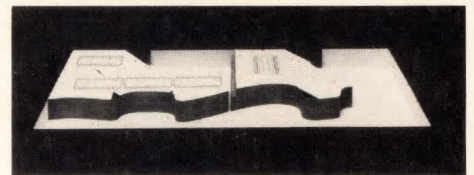

Monolithic Memories

OTA readies new studies on EDP, telecommunications

Citing telecommunications and computers as emerging fields of congressional interest, the Office of Technology Assessment is preparing four preliminary analyses in case its board of congressmen calls next year for full-fledged assessments. The studies (and the committees that will receive them) include: electromagnetic pollution, its effects, and standards to regulate radiation-source intensities (House Interstate and Foreign Commerce); electronic mail, its long-term effects on jobs and other socio-economic factors (House Post Office and Civil Service); law enforcement and the effectiveness and impact of computerized information systems (House Judiciary); and new issues on tax-system computerization and access to returns (House Judiciary). **A fifth electronics-oriented study for the House International Relations Committee will cover international technology transfers** in terms of U. S. competitiveness, employment, trade balances, and national security. All will be under the technology office's new director, Russell Peterson, who is scheduled to start his new job on Jan. 16 [*Electronics*, Nov. 10, p. 49].

NASA sets tests for first portable X-ray device

Using a second-generation Army fiber-optic image-intensifier tube and an 18- or 25-mm viewing diameter, a National Aeronautics and Space Administration research team headed by Lo I Yin has developed a prototype hand-held portable X-ray machine. Called Lixiscope—for low-intensity X-ray-imaging scope—the unit is powered by a penlight battery. It was developed at Goddard Space Flight Center, Greenbelt, Md. Three prototypes will begin six to nine months of clinical evaluation in January at selected medical and dental centers.

Approximately the size of a human fist, the cylindrical prototype contains a viewing screen in the center. At the rear, **mounted on an extendable rod, is a smaller metal cylinder not much larger than a thimble**, containing an interchangeable radioactive source of 10 to 20 millicuries—cadmium 109 and iodine 125 are being tested. The object to be examined is placed between the source and the scope, and the Lixiscope is triggered, unshielding the source. Low-dosage X rays pass through the object and are absorbed by a phosphor screen, which converts them to visible light. The fiber-optic night-vision unit collects the light, intensifies it with incident light by a factor of 40,000, and channels it to the viewing screen for display.

Addenda

The Office of Management and Budget wants industry comments by Jan. 20 on proposed revisions of Federal procurement policy circular A-76 **that will favor government purchases of goods and services from commercial sources** over in-house efforts. A key issue in dispute is calculation of Federal pensions in Government payroll costs. The OMB proposes to raise it to 20.4%—a compromise between the 14.1% now used and the 24.7% factor used earlier. . . . Prospective suppliers of data-transmission hardware to Satellite Business Systems Inc., McLean, Va., **are waiting for the 'product-opportunity conference' being prepared by the company**. SBS, which is aiming for early 1981 operation of its satellite net, just completed a day-long briefing for 50 teleconference equipment vendors covering image and document scanners, image enhancement, storage and display devices, and audio components and systems.

Licensing the Lixiscope

The National Aeronautics and Space Administration is touting a new—and possibly its best—example of technology transfer. It is a small handheld X-ray machine powered by a penlight battery and called a Lixiscope—for low-intensity X-ray imaging scope (see p. 47). Conceived by NASA's Lo I Yin at Goddard Space Flight Center, the Lixiscope employs a second-generation image-intensifier tube that uses fiber optics and was derived from the Starlight scope used by riflemen in Vietnam for night combat.

There is indeed a certain irony that the Lixiscope, with its great potential for peaceful use, should evolve from a weapon of war. The greater irony lies in the fact that NASA's Technology Utilization Office, which licenses its aerospace spinoffs to industry, has thus far received its only Lixiscope queries from Japanese instrument makers, according to Yin. On the American industrial front, technology transfer by any Federal agency has proved pretty much a flop from the beginning. Now that American corporate uninterest is magnified by inquiries from Japan—the nation that many U.S. electronics executives charge can compete only when they have an unfair advantage.

NASA believes the Lixiscope's potential applications range all the way from on-field examination of possible bone fractures in athletes to measurement of solar gamma ray bursts in the 10-to-500-kilovolt region by researchers aboard the space shuttle. Between those extremes are markets in dentistry, emergency surgery, and such industrial uses as examination of large-scale integrated circuits or gas pipeline welds for defects. NASA's Yin puts the Lixiscope's production cost at \$5,000.

Another transistor radio?

What will American managers say in years to come should Japan license Lixiscope technology and perfect a new instrument for the world's largest medical market—the United States? The old argument that Japan subsidizes its industries through the Ministry of International Trade and Industry will not work. This time it would be an American subsidy. The prospect recalls the visit of Sony Corp.'s Akio Morita and others to Bell Laboratories in order to license the transistor shortly after its development in 1947. Bell staffers “laughed at us when we told them we planned to make transistor radios,” Morita recalled in a conversation several years ago. He smiled broadly as he recalled the story.

But members of the Electronic Industries Association were not laughing in 1959 when

they petitioned the Federal government to limit transistor imports from Japan on the ground that they were eroding the U. S. industrial base and thereby threatening national security. Neither did they laugh three years later when their case was dismissed.

“The cases are legion,” contends H. William Tanaka, an American lawyer in Washington who regularly represents Japanese electronics interests. He cites the 1962 example of Sony's development of the 8-inch, transistorized, portable monochrome television receiver. “Again, instead of laughing at Sony, if domestic producers had taken the risk to design, manufacture and market small-screen TVs, would the Japanese now occupy the market that they do in larger-screen sets?” Tanaka clearly believes the answer is no. He argues his case in detail elsewhere in this issue (see p. 72), but there are other issues that American manufacturers should consider as well.

A risky business

A key one is the question of American corporate willingness to take a risk—with its own money—and develop new markets with new products and let the customer decide. It is disturbing to face the prospect that competitive risk-taking may be on the decline, but there is increasing evidence to that effect. One instance is the slowing of U. S. corporate investment in research and development. A Carter Administration plan to stem that decline next year with more Federal R&D money appears to be more of a stopgap than a solution [*Electronics*, Nov. 24, p. 59].

Another bit of evidence appeared during the National Academy of Engineering annual meeting last month, when the audience seemed most impressed by what the NAE's corporate panelists did *not* say. Virtually every speaker was able to itemize complaints about what the Federal Government was doing to hamper American industrial development. The lists embraced everything from high taxes and excessive controls on occupational health and safety and the environment down to insufficient Federal funds for Federal research and development. Not once did any speaker volunteer what his company or industry proposed to do for itself to enhance its own competitive standing in the hierarchy of modern technology. It was enough to make a listener wonder if U. S. corporate management has forgotten the favorite saying of an earlier entrepreneur, Ben Franklin, that “God helps them that help themselves.”

Ray Connolly

There's a better way to measure or monitor mechanical motion—

magnetically-activated 'Hall effect' integrated circuits

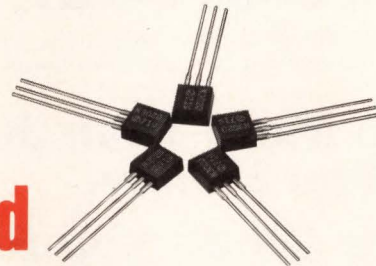

- Convert mechanical motion to electronic signals by sensing changing magnetic fields.
- Excellent for position sensing, thickness determination, weight measurement, speed control, pressure monitoring.
- Provide contactless switching—no contacts to wear, no contact welding.
- Highly reliable under adverse environmental conditions.

- None of the contamination problems suffered by mechanical or photo-electric switches.
- No moving parts to cause spurious signals often associated with conventional switches.
- Economical transistor-style package.
- Ideal interface between mechanical motion and electronic controls, counters, etc.

TYPE UGN-3020T DIGITAL SENSORS

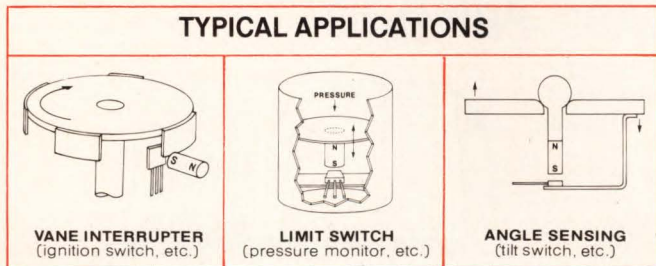

- Designed for use with readily-available samarium cobalt or sintered alnico VIII permanent magnets.
- Operate at any voltage from 4.5 to 24 VDC.
- Constant amplitude output, independent of frequency up to at least 100 kHz.
- Higher sensitivity, wider operating temperature range, smaller physical size, more economical than any other device of its type.

TYPE UGN-3501T LINEAR SENSORS

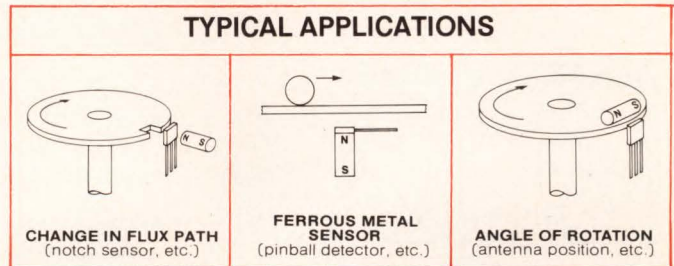

- Voltage output of these devices is proportional to magnetic field intensity.
- Will operate if slightest change in flux path is made.
- Operate at any voltage from 8 to 12 VDC.
- Hall cell and linear differential amplifier integrated in one monolithic device to simplify problems relating to handling of millivolt analog signals.
- Exceptional temperature stability.

Call your nearest Sprague stocking distributor for price and delivery information. For easy-to-understand application engineering assistance, write or call John Haussler, Hall Cell IC Product Manager, Sprague Electric Co., 70 Pembroke Rd., Concord, N.H. 03301; telephone 603/224-1961. For complete technical data, write for Engineering Bulletins 27404.11 and 27500 to: Technical Literature Service, Sprague Electric Co., 35 Marshall St., North Adams, Mass. 01247.

45S-7131



THE BROAD-LINE PRODUCER OF ELECTRONIC PARTS

FIRST COMPUTER CORPORATION

And **FIRSTLAB™**—A New Family

DEC® Lowers Prices.

Digital Equipment Corporation recently announced substantial price reductions for selected components and certain packaged systems.

And So Does FIRST.

First Computer will pass these reductions along to you, and will provide our regular discounts from these low prices.

We Do More Than Just Save You Money.

Service When You Buy.

● Fast Delivery.

Prompt delivery of factory fresh LS1-11 microprocessor components and products is provided off-the-shelf. Plus, we stock complete microprocessor based computers and can rapidly deliver both standard and custom systems in 30 to 60 days!

● Personalized Service.

Each customer and order is handled on a personalized basis. We can help you configure your system or select the proper components. Quick replies to requests for information and courteous treatment are assured.

● Added Value.

Valuable software enhancements for the systems delivered by FIRST COMPUTER are available from our continually growing software library, including the new FIRST-SORT-11™. Custom configurations are built to order, fully integrated, and thoroughly tested prior to shipment.

● Hard Disk System Upgrade.

The RK05® Hard Disk units are now available for upgrading of your 11V03® computer systems, providing up to 20,000,000 bytes of storage.

● Something Special? Custom Configurations.

We will custom build systems to your specific requirements, with no resulting delay in delivery. We can also package your system in a functional, attractive desk, and provide additional memory, interfaces, terminals, and peripherals.

In addition to a full line of PDP 11/03® computing systems, you have your choice of four 100% pure DEC 11/03® Lab systems.

NEW LAB-IN-A-BOX™ PDP 11/03®

- 16K words (32K bytes) of MOS memory standard.
- Most economical member of the FIRSTLAB™ family.
- Supports all lab options in a single chassis.
- 500,000 bytes of Diskette storage standard.

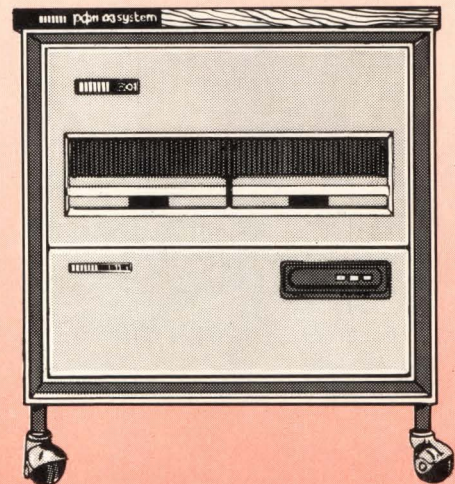

NEW BIGLAB™ PDP 11/03®

- 16K words (32K bytes) of MOS memory standard.
- 500,000 bytes of Diskette storage standard.
- Attractive, functional desk console.
- Capability for expansion to the maximum 11/03® configuration.

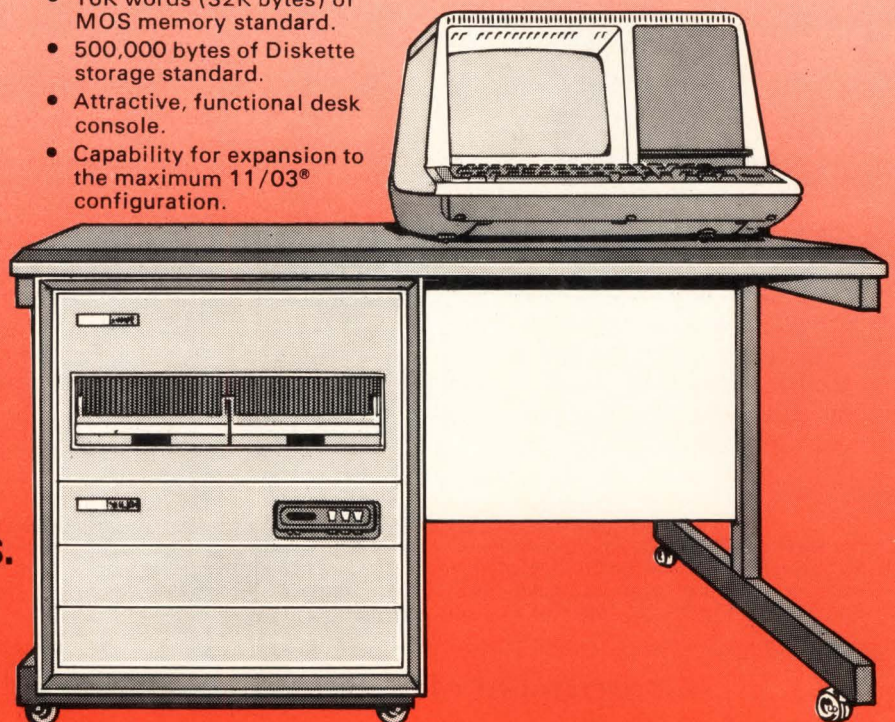

Announces Lower Prices Of PDP 11/03[®] Lab Systems.

The **FIRSTLAB[™]** family:

- **LAB-IN-A-BOX[™]**
- **BIGLAB[™]**
- **DECLAB[®]**
- **SUPERLAB[™]**

NEW SUPERLAB[™] PDP 11/03[®]

- 28K words (56K bytes) of MOS memory standard.
- 7.5 Meg bytes of Disk standard.
- Expandable to 20 Meg bytes of Disk.
- Capability for expansion to the maximum 11/03[®] configuration.

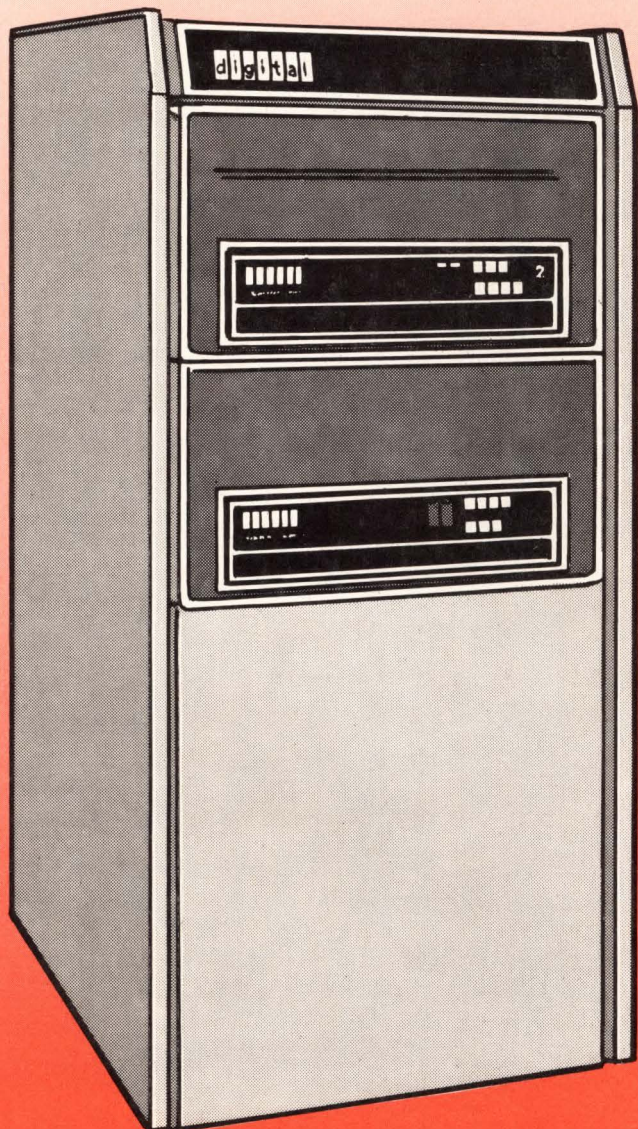

Service After You Buy.

- **No Matter Where You Are,
World Wide Field Service.**

All systems delivered by FIRST COMPUTER consist entirely of DEC[®] products and conform fully to DEC[®] specifications, thus qualifying for on-site field service by DEC's[®] own factory trained technicians *world wide*.

- **Warranty**

We provide the same warranty as DEC[®].

- **And Something More, PEP**

Our Priority Exchange Plan (PEP) can assure you of meeting your needs for critical spare parts.

More For Your Dollar.

You can buy custom DEC 11/03[®], DECLAB[®] equivalent, or DEC 11V03[®] computing systems with up to a 20% savings from FIRST COMPUTER. Why spend more and wait?

SAVING YOU MONEY.

SAVING YOU TIME.

TWO GREAT IDEAS, ONE GREAT COMPANY.

FIRST COMPUTER CORPORATION

764 Burr Oak Drive

Westmont, Illinois 60559

Computer systems • Components • Accessories

Call **FIRST** first to find out
how much you can save—
(312) 920-1050

® Registered trademark of Digital Equipment Corporation, Maynard, Mass.
™ Trademark of FIRST COMPUTER CORPORATION, Westmont, Ill.

**"We've cut up to 80%
of our negative costs and
reduced our lab labor
time by half thanks to
reprographic techniques."**

**Bill Williams, Manager,
Still Photo Services Lab,
General Dynamics Corporation,
Fort Worth, Texas.**

"The F-16 Air Combat Fighter that General Dynamics is manufacturing for the U.S. Air Force and five allied nations is based upon thousands of engineering drawings—many eight-foot J size. And most of them have funneled through our Still Photo Services Lab for reproduction.

"When you're creating a new airplane, designs and specifications are often changed—until you're sure you're producing the finest aircraft for the mission defined by the Air Force. So, new drawings are needed. It's much easier to use reprographic techniques and make small changes photographically than it is to redraw everything.

"Before we installed our new Kodak Supermatic processor and process camera, we shot everything same-size and tray-processed. We'd shoot our J-size drawings in sections and then splice the whole thing together. I claimed my technician used a four-inch brush to opaque pinholes in negatives.

"Now we shoot the drawings down five to seven times, opaque the reduced-size negative, and come back to a full-size second original with absolute accuracy. All the Kodagraph products go through the processor—so do a lot of our publicity photos. One person processes the same number of line drawings that two technicians did when we were using a wet line. And our savings on negative material alone run between 50 and 80 percent."

Reprographics can help you, too.

Send for more details about General Dynamics' use of reprographic techniques, plus, a complete listing of Kodak products and other applications. Write: Eastman Kodak Company, Graphics Markets Division, Dept. R04805, Rochester, N.Y. 14650.

**VERSATILITY IN
REPROGRAPHICS**



Circle 52 on reader service card

Yen's rise means drop in sales, says Matsushita

The 10% increase in the value of the yen since September will mean significantly lower profits in the second half of Matsushita Electrical Industrial Co.'s fiscal year, says president Yoshihiko Yamashita. In addition to the drop in profits, export sales probably will decline 10% to 20% from their present level of a quarter of the firm's sales, he says. **Twice already this year, Matsushita has adjusted prices for the appreciation of the yen,** with the firm itself absorbing a third of the increases. A new round of price increases will be shared equally by consumers and the company—unlike the other two rounds, distributors cannot be expected to absorb any of the new appreciation, the company feels.

Japanese set makers push for drops in prices of components

Japanese manufacturers of TV and stereo equipment are pushing components makers to reduce prices by 2% to 8% and thus absorb part of the exchange loss brought about by the rising value of the yen. **In a similar move earlier this year, the set makers sought similar reduction, but settled for discounts of 1% to 3%.** This time around, the components makers are fighting price cuts even harder, because they are afraid of being forced below the break-even point. However they are in a weak position, since demand is dropping.

\$2 billion predicted in 1978-1983 sales of electronic-warfare gear

The international electronic warfare equipment market excluding the U. S. from 1978 to 1983 will be \$2 billion, with the major markets being Western Europe and the Mideast, forecasts Frost and Sullivan Inc. of New York. **"The expanding air forces and navies of Western Europe represent more than one-half the total market,"** the market research firm says. The major air force segment will be for active jamming devices, for a total of \$665 million, while passive and warning systems are expected to receive a total of \$190 million. Spending for naval equipment in Western Europe is pegged at \$230 million for the period. In the Mideast, the growing air forces of Iran, Saudi Arabia, and Israel, plus those of other Arab nations, should result in air force spending of slightly over \$300 million with active jamming systems again being the largest segment—\$190 million. **An emerging market is Japan,** the firm says, with expenditures of \$48 million to \$80 million in the period, mostly on R&D. Other countries around the world will spend another \$300 million.

Four French firms get OK to develop facsimile gear

After a bitterly fought contest, the French post office has decided to split its contract for the development of facsimile transmission equipment, worth around \$1.5 million, among four French firms. CIT-Alcatel, Matra, Sagem, and Thomson-CSF will develop prototypes of a machine that will transmit a 21-by-29.7-cm page in 2 min. **The work could make France the first country in the world to have a significant electronic mail system.** The unit is slated for a basic annual production of 120,000. Meanwhile, LETI, the electronics laboratory of France's atomic energy agency, is working with post office researchers on a 1,728-element optical reading and writing array for facsimile units.

Simplify your life and save a little real estate.

Introducing RM5 cores . . . another small accomplishment from The Cube.

Designing filters with standard pot cores? Or transformers with 3E2A material specs? And you just don't have enough space for the core set, connection terminals and mounting clips. We can make your job a little easier.

Save up to 40% of PC board real estate

Using our new RM5 square cores and bobbins, you can save up to 40% in mounting requirements compared to standard pot cores. You save real estate with no loss in performance specs. And, you save assembly time.

Like a pot core set, the square core is assembled from core halves enclosing a wound bobbin. The wound bobbin is placed in the bottom core half; the top core is put in place; two simple spring clips hold the set together; pins at the bottom of the clips fit the standard 0.1" PC board grid, firmly anchoring the assembly. That's all there is to it!

The new RM5 square core give the circuit designer the same classic combination of high Q, high stability of inductance, reliability and repeatability of characteristics as our established RM6 and RM8 cores. For filter applications it is available in 3D3, 3B7, 3B9 and 4C4 materials. For transformer applications it is available in 3E2A material. And it is produced in ungapped, fixed-gap and adjustable gap styles. For complete specs on RM square cores, bobbins and hardware, call on The Cube.

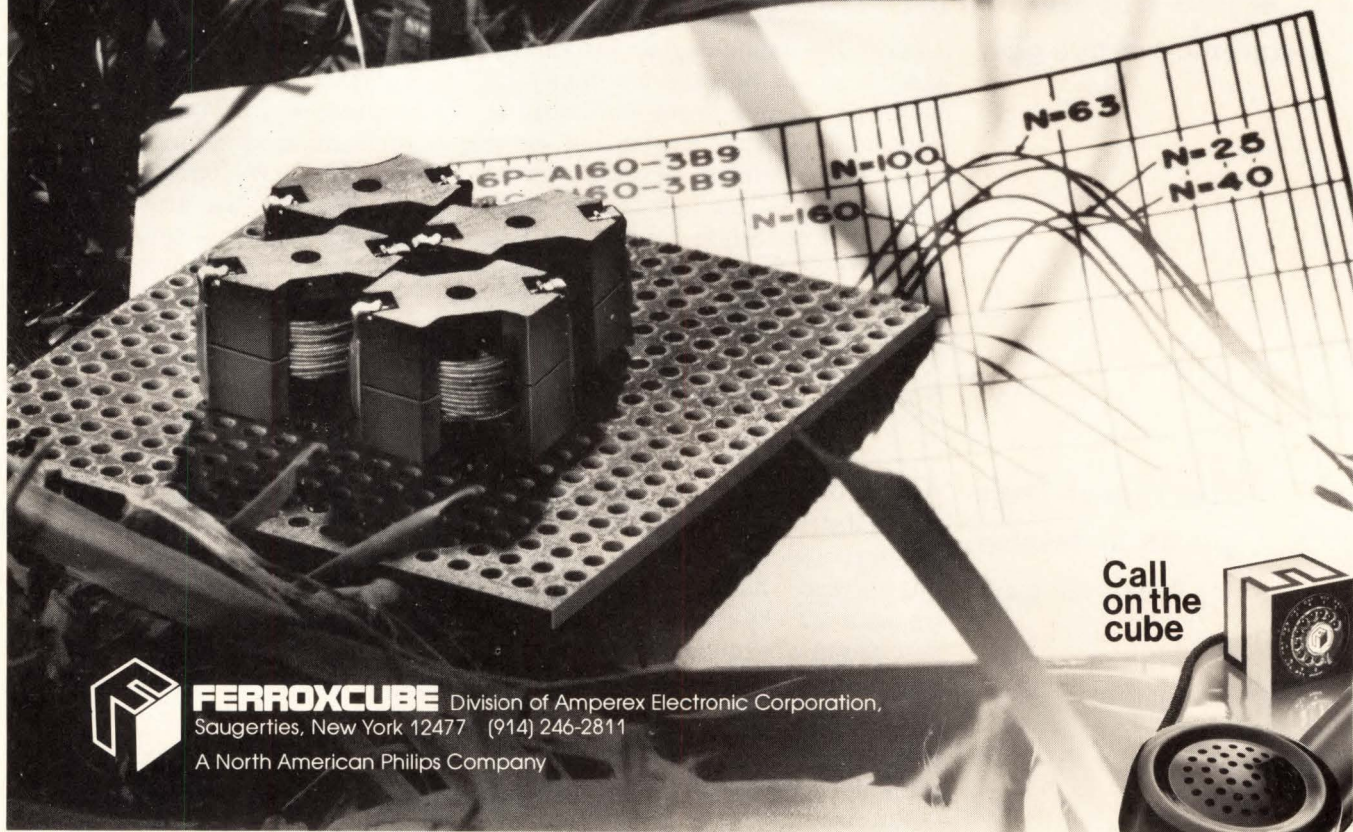

Call
on the
cube



FERROXCUBE Division of Ampere Electronic Corporation,
Saugerties, New York 12477 (914) 246-2811
A North American Philips Company

System with 13 8080s aids operators in small phone offices

Telephone operators still handle plenty of calls, usually the complicated ones like credit-card, person-to-person, and so on. To make life easier for them, Great Britain's Standard Telephones and Cables Ltd. has devised an automated system using an array of 13 distributed microprocessors and fitting into existing phone systems.

The new OPAS, for operator-position-assistance system, will cut the number of operations required to set up a typical call from 33 to 17—automatically logging call details and eliminating the need to make out toll tickets. Once recorded, the details are used for both routing and record keeping. For example, OPAS can make unlimited repeat attempts to set up a connection.

Developed by the British Post Office and production-engineered by STC, the new system will soon go into use in Sweden and Great Britain. Architecturally, it marks a major departure from highly centralized computer-controlled operator-assistance systems that other equipment makers offer.

For example, Bell Telephone Manufacturing Co. of Belgium, an ITT subsidiary as is the British firm, has its MAP system. This setup can service 446 operator positions with its powerful minicomputer and is designed for installation in a big exchange when the telephone network is being expanded. In contrast, OPAS is designed to handle 32 operator positions in already functioning small exchanges. Moreover, its multiprocessor configuration has the advantage of modularity.

13 microprocessors. The new equipment can be readily incorporated into existing operator positions by the provision of a keypad, a display unit, and logic interface circuitry. The operator keys such information as the caller and called numbers directly into the system. As

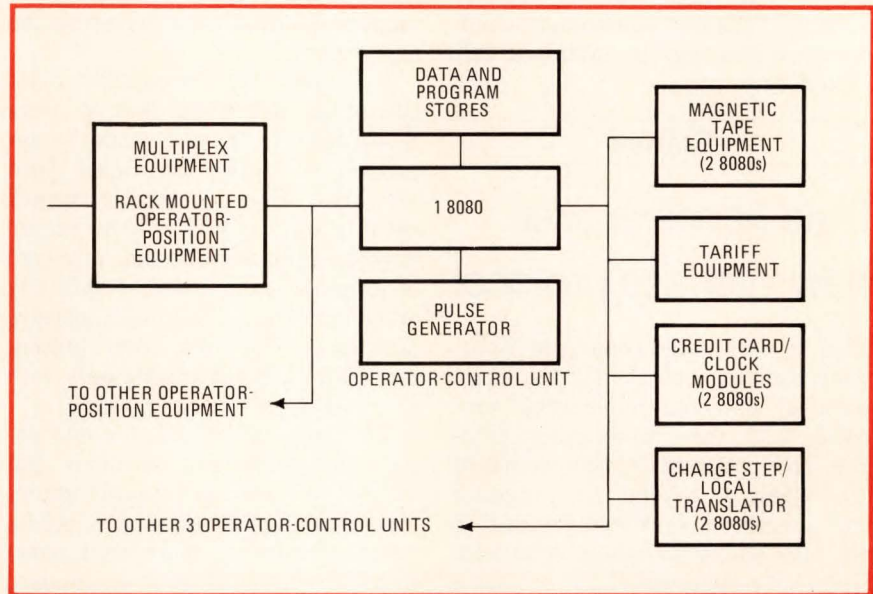

Distributed 8080s. STC's new operator-position-assistance system—OPAS—reduces the number of steps operators must take in handling typical calls from 33 to 17.

data is entered, it appears on a novel dc electroluminescent display panel.

System functions within OPAS are split among 13 Intel 8080s in a 32-station configuration such as the one the Swedish telecommunications administration is buying to route mobile telephone calls through its network. Each of the four operator control units has a microprocessor that enables the unit to control data transfers between as many as eight operators and the common equipment (see figure). The 8080 also formats the display data. If one of the units goes down, its load may be split between two adjacent units.

The common peripheral modules include the credit-card unit, the tariff unit, and the charge-step/local translator, which compares area codes to work out toll charges and, in the British system, automatically routes both long-distance and local calls. As requested by the operator, the control unit calls up the tariff rate, credit-card information, routing information, and the like.

The distribution of functions

among the various microprocessor-controlled modules and the duplication of modules contribute to the system's high reliability. Also important for reliability are the maintenance monitor and diagnostic units, with an 8080 in each.

The monitor unit is in continuous touch with the operator control units and the peripherals. It can detect a malfunction but not the reason for it. It will switch out the faulty element, whose load is transferred to duplicate units on peripherals, and will signal the fault to the maintenance engineer. It also compiles a broad range of management statistics.

With the aid of the diagnostic unit, the engineer can track down the fault. He applies test patterns to the system to diagnose the problem.

At other times, the diagnostic unit routinely tests spare circuit boards, which are in a hot standby module that contains the last of the 13 microprocessors along with spares for the system's other boards. A board failure is signalled to an engineer, who can replace a faulty card

with one from the stock in the standby unit.

The British firm believes there will be follow-on Swedish business to this first \$700,000 order. Also in the next few months, the British Post Office will take delivery of its version of the new equipment, which is known as ACRE, for automatic call recording. □

France

Data handlers offer new interface protocol

Despite widespread support by European common carriers for the international data-communications protocol X.25, the French group Inforep has proposed a new standard that would go beyond that to reduce the amount of hardware needed to tie into packet-switching networks. The CCITT-approved X.25 specifies a standard way of converting data-transmission formats at user interfaces into the format demanded by a network.

The problem with X.25, says Inforep, an influential group of computer users, is that it requires some form of black box between the user interface and the network. Members of the group are already discovering the costliness of such hardware as they gear up to use Transpac, the French public packet-switching network due next June.

Virtual terminal. So the group is proposing a protocol that goes beyond X.25 to allow communication without the costly conversion hardware. Its proposals are based on the concept of a virtual terminal: a single module—probably software—at the user's central processor. This module would take care of line protocols between each terminal at the node and the user's processor, as well as providing the commands for the terminal. The terminal operator would address messages to the network and receive them from it, and the central processor would take care of both the line protocol and terminal operation.

In effect, Inforep looks upon the interconnection protocol as a matter of dealing with terminal-to-terminal communication, where X.25 considers it a matter of dealing with interface-to-interface communication. X.25 could become just one of a number of protocols handled by the new approach.

For users, the proposal's chief advantage would be that it frees them from a single vendor's approach to tying terminals into networks. Every central-processor manufacturer would have to set up its node equipment so that any type of terminal could converse with any other type without adding expensive hardware. Moreover, most present processors are compatible only with terminals from the same maker.

The proposed standard would entail some changes in terminals. But instead of specific microprogrammed emulation of another manufacturer's terminal or more black boxes to convert the equipment to standard protocols, there will be a small amount of microprogramming in the

terminal to allow it to accept the standard virtual-terminal software and to intercept any specific physical commands that may be sent down the line to the terminal.

Consideration. Inforep's proposal is under consideration by the French standards authority, Afnor. Moreover, IRIA, the national information-processing and automation research institute, is working with a Thomson-CSF division on a prototype that will fit the proposed protocol.

Reaction of equipment makers is not yet known, but there is little reason to believe they will favor a concept that permits users to easily match equipment from different manufacturers. On the other hand, the Paris-based computer maker CII-Honeywell Bull is also proposing a virtual-terminal standard. Inforep's vice president, Jean-Claude Albrecht says that proposal comes very close to his group's protocol. He notes that the move is a significant turnabout from previous company policy, which held that protocols are the business of vendors, not users. □

Around the world

CAT scanner displays image in seconds

Now in production at Siemens AG's plant in Erlangen, West Germany, is a whole-body CAT scanner that provides an instant picture, thanks to the incorporation of a PDP 11/04. Competing units may perform the body scan for computerized axial tomography [*Electronics*, Oct. 14, 1976, p. 89] in as few seconds as Siemens' Somatom, which reduces the amount of radiation to which the patient is exposed. But the Somatom's instant-picture feature further reduces the radiation by cutting the number of scans that occur as the image is built up and displayed.

A Siemens-developed image processor using pipeline principles implements the feature. With these principles, processing of the radiation-absorption data from body tissues keeps pace with the measuring process itself. Thus the computer tomogram is ready right after the end of the scan. Controlling the data-processing procedure is the 11/04, which also coordinates operation of the CAT scanner's parts and supervises data exchange among them.

Low-cost process gives low-loss glass-fiber cables

Great Britain's Pilkington Brothers Ltd. is phasing in a new manufacturing process for low-attenuation glass fibers [*Electronics*, Nov. 10, p. 53]. Developed at the Catholic University of America, it uses relatively low-cost, widely available materials. The technique removes impurities from borosilicate glass by phase separation. This leaves a very pure rod with a high silica content and a microscopic honeycomb structure. The rod is chemically treated so that its interstices absorb material of the required refractive index. Then it is drawn into fibers with an attenuation of 20 dB/km. Cost is around 68¢ a meter for a 50-km package of single-fiber cable, but the firm expects that to drop to around 17¢ once volume production begins.

**Now, a new generation
of semiconductor-grade
molding compounds.**

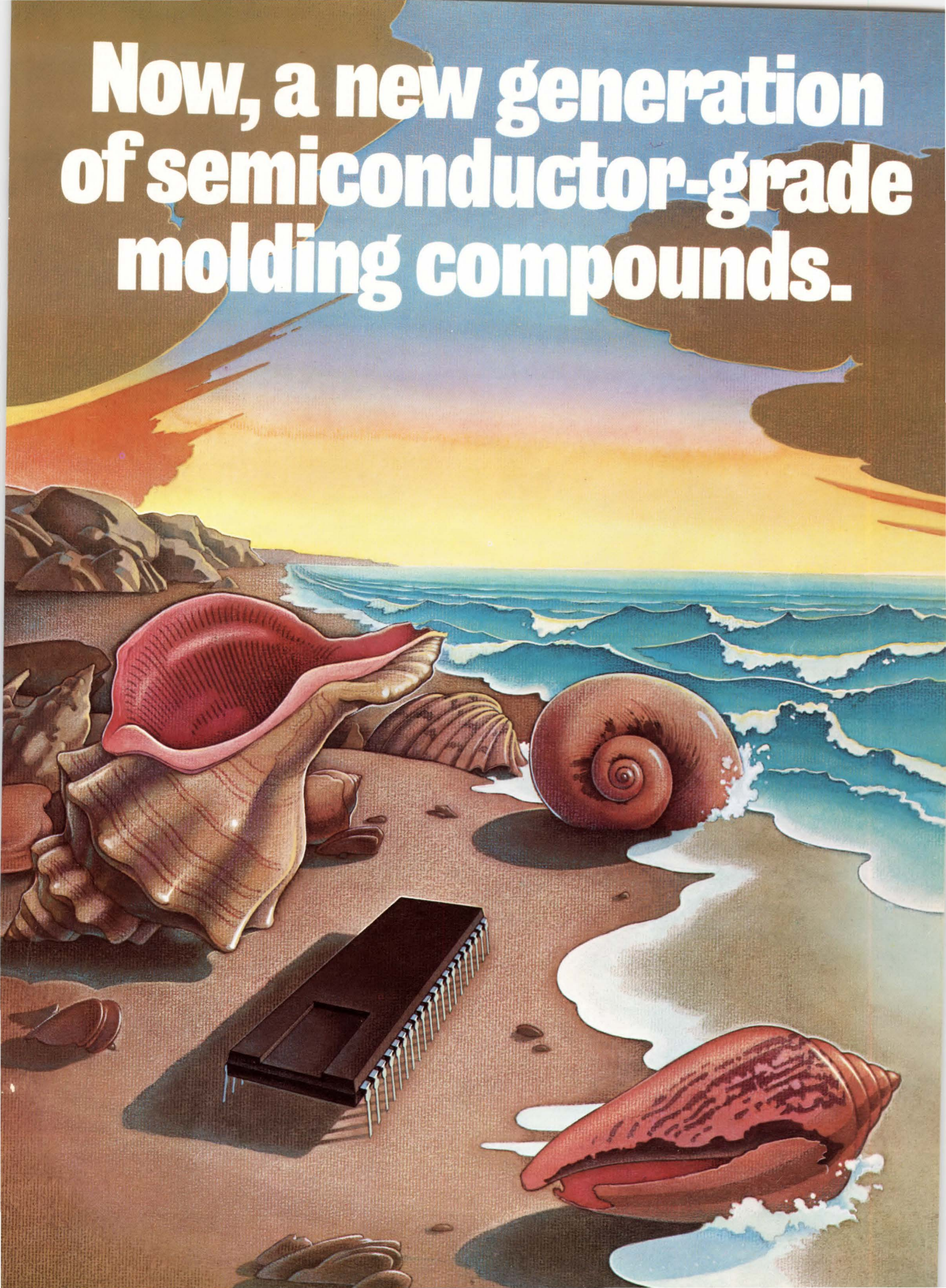

Dow Corning 631 molding The advantages of silicone. The advantages of epoxy. And something more.

At first it might appear pretentious to announce a new generation of semiconductor-grade molding compounds. "New generation" implies a product so outstanding, so totally unique, that it overshadows all existing technology. But that is precisely what we have developed. We've taken the best advantages of silicone. The best advantages of epoxy. And put them together in one very unique product. Dow Corning® 631 silicone/epoxy molding compound.

What this new generation of molding compound means to you is that now you have the best advantages of silicone and epoxy in one product specifically designed for integrated circuit applications. And it means something more. It means that now every other molding compound is second best.

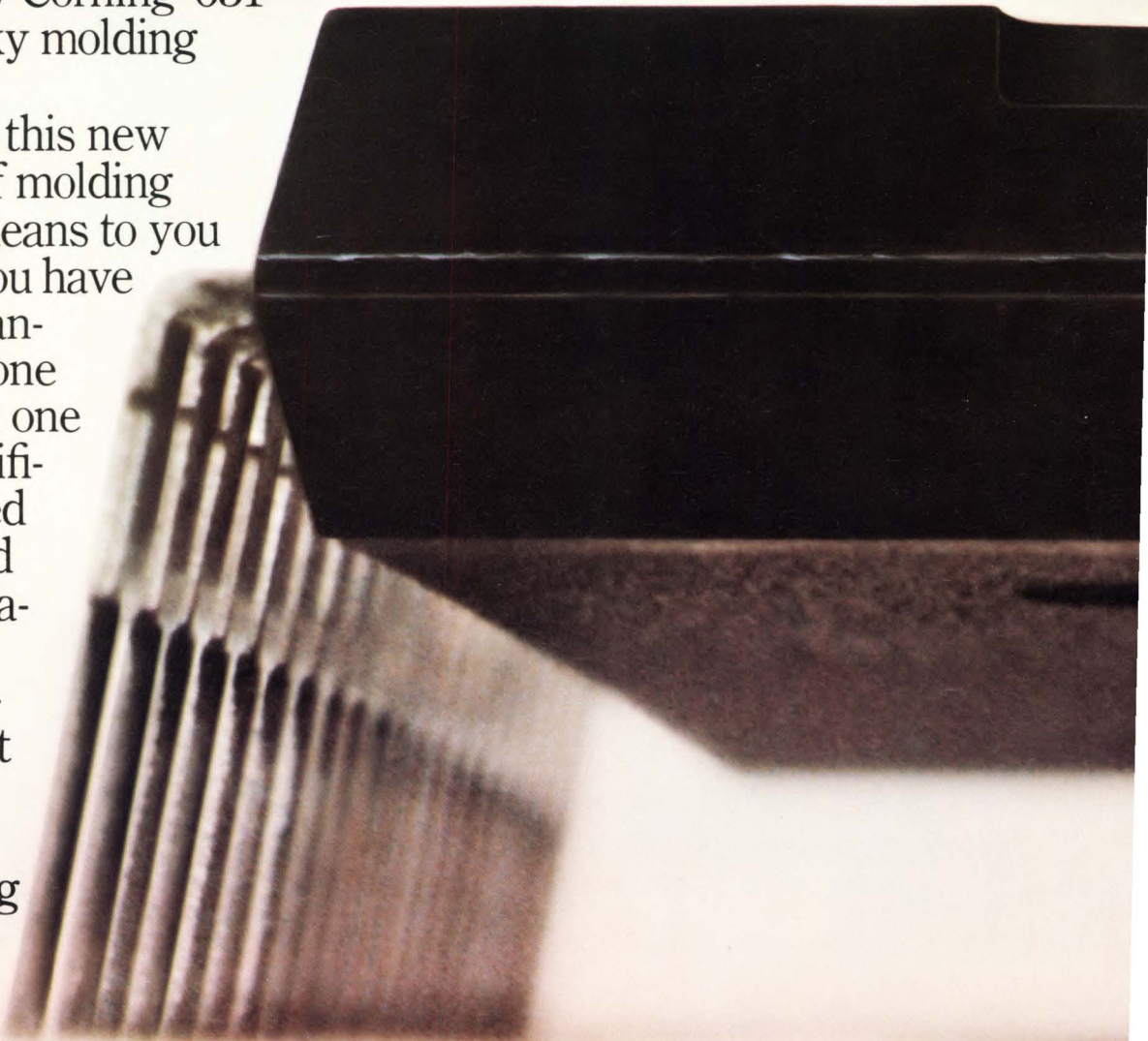

compound.

Dow Corning 631. Better than silicone.

Dow Corning 631 silicone/epoxy molding compound represents a breakthrough in a very real sense. It's the only molding compound that combines the compatibility and ease of molding of silicone compounds with the salt atmosphere resistance of epoxy compounds. The graph at right proves our point. After 600 hours' exposure to corrosive salt atmosphere, none of the devices that were molded in Dow Corning 631 silicone/epoxy compound failed. That's a major advantage over ordinary silicone molding compounds.

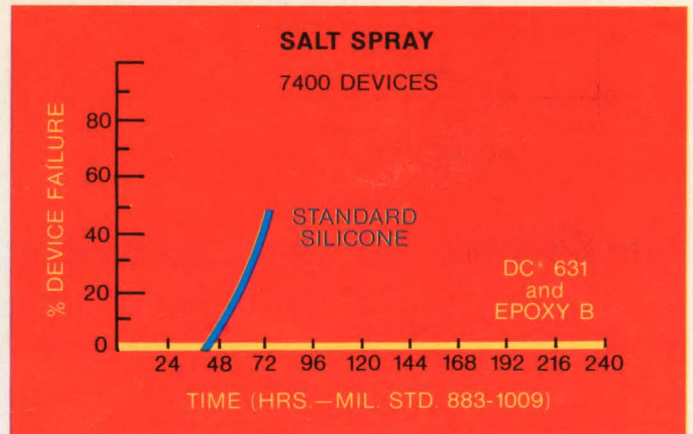

Dow Corning 631. Better than epoxy. Dow Corning 631's advantages over silicone are only half the story. It's also the only molding compound that combines the high strength and strong lead seal of epoxy with the

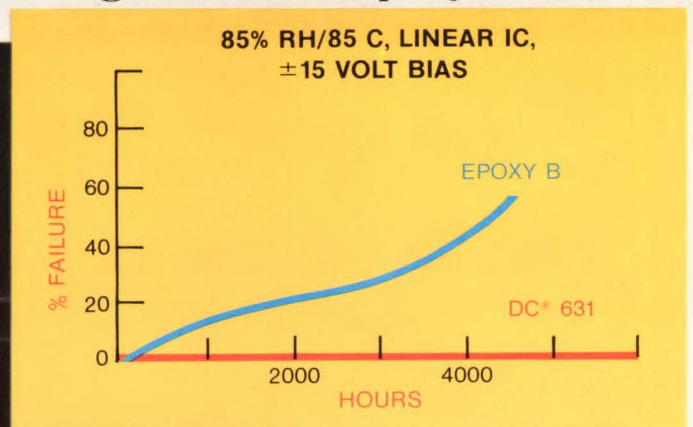

outstanding moisture resistance of silicone. The autoclave resistance of Dow Corning 631 is very nearly as high as that of an all-silicone molding compound. And look what happened on 85°C/85% R.H.-bias testing.

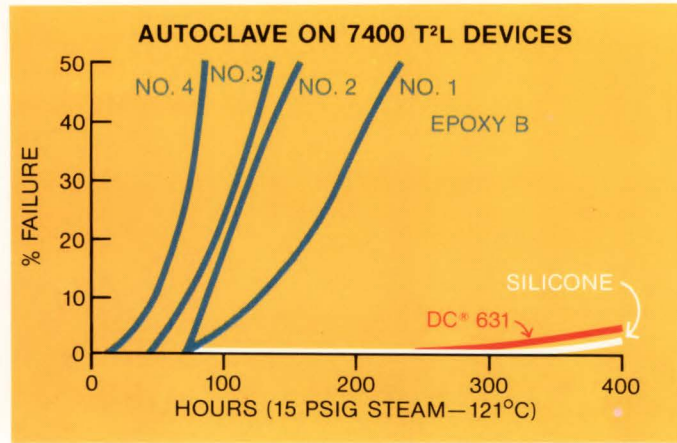
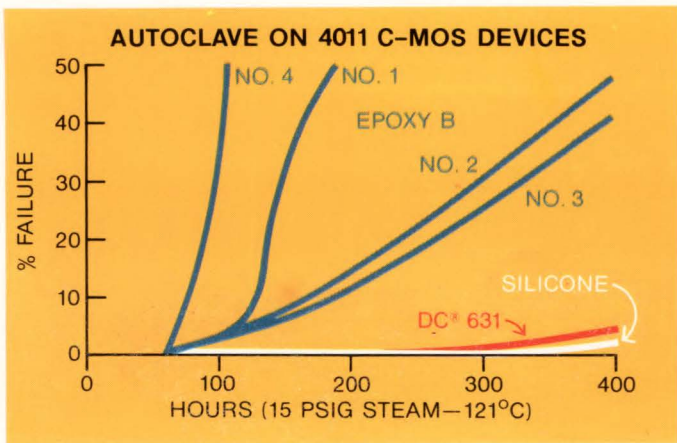

Dow Corning 631. Unmatched design flexibility. Dow Corning 631 silicone/epoxy molding compound gives you the compatibility, the moisture resistance and the unmatched ease of molding of silicone compounds. It gives you excellent 85/85-bias protection. It gives you the high strength, the strong lead seal, and the superb salt spray resistance of epoxy compounds. And it gives you all those advantages in one product. You can solve a problem with Dow Corning 631 that you wouldn't even approach with conventional molding compounds.

You have our word on how good Dow Corning 631 is. But we don't want you to just take our word for it. We want you to see for yourself. For samples and more information, write Dow Corning Corporation, Box 1767, Midland, Michigan 48640. Or, for immediate attention, call (517) 496-4682.

**Dow Corning 631 silicone/epoxy molding compound.
Now everything else is second best.**

Hong Kong

Dow Corning Asia, Ltd.
P&O Building, 9th Floor
21 Des Voeux Road C
Ph. 5-258035/7

Toronto

6747 Campobello Road
Mississauga, Ontario L5N 2M1
416/826-9700

Brussels

Dow Corning International, Ltd.
Chaussee de la Hulpe, 177
1170 Brussels, Belgium
Ph. 02/673.80.60

Munich

Dow Corning GmbH
8 Munchen 50
Pelkovenstrasse 152
Ph. 89/14861

France

Dow Corning SarL
140 Avenue Paul Doumer
92500-Rueil Malmaison, France
Ph. 1/977.0040

São Paulo

Dow Corning do Brazil Ltda.
Caiza Postal 4102-01000
São Paulo, Brazil
Ph. 52-2572, 52-8672

Mexico City

Dow Corning de Mexico, S.A.deC.V.
Paseo de las Palmas 751, Piso 5
Mexico 10, D.F., Mexico
Ph. 905 5 40 31 10

DOW CORNING



Cost efficiency you can put your finger on . . . CORTRON® SOLID STATE KEYBOARDS

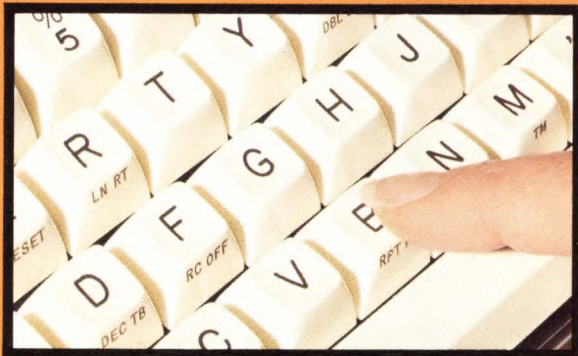

Get your hands on a CORTRON Solid State Keyboard, and you'll soon find out why you can't judge all keyboards on initial price alone.

It's after installation that cost efficiency becomes most important. In life expectancy, ability to endure extreme environments, high speed operation without "misses," accuracy, downtime caused by beverage spillages, reliability, serviceability and human engineered features. That's where a CORTRON Solid State Keyboard really pays off.

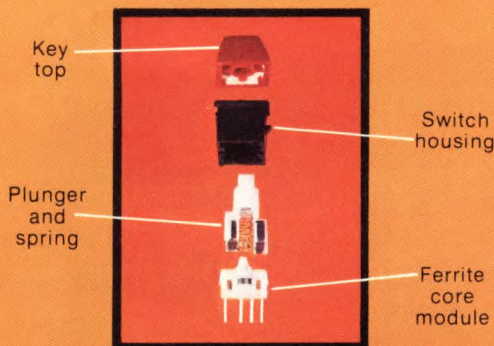

Unique contactless key switch makes the difference. Utilizing ferrite core switching technology, the CORTRON Key Switch is mechanically simple (only 4 basic parts!) and has an ultra reliable 100 million cycle life test rating. CORTRON Keyboard Professionals can translate what this can mean to you in cost efficiency terms of MTBF (mean time before

failure). CORTRON has actual customer experience of MTBF in excess of 40,000 hours.

They'll also explain other advantages you'll gain over competitive technologies such as Hall effect, reed switch, and capacitive switching. All in all, you'll find the CORTRON Key Switch offers unusual built-in protection against costly service calls and the hardship of downtime.

"Human engineered" keytops and key placement options give CORTRON low profile alpha numeric keyboards the familiar "typewriter feel" that promotes operator productivity and efficiency.

Nothing left to chance. CORTRON solid state keyboard materials, components, sub-assemblies, and final assembly are 100% inspected and tested to assure your specifications are met with plenty of room to spare.

These are just a few of the cost efficiency benefits CORTRON offers you and your customers.



Cost efficiency you can put your finger on. For a greater insight into the cost efficiencies attainable with a CORTRON Solid State Keyboard, write or call for details: CORTRON, A Division of Illinois Tool Works Inc., 6601 West Irving Park Road, Chicago, Illinois 60634. Phone (312) 282-4040. TWX 910-221-0275.



CORTRON
A DIVISION OF ILLINOIS TOOL WORKS INC.

THE KEYBOARD PROFESSIONALS

Circle 57 on reader service card

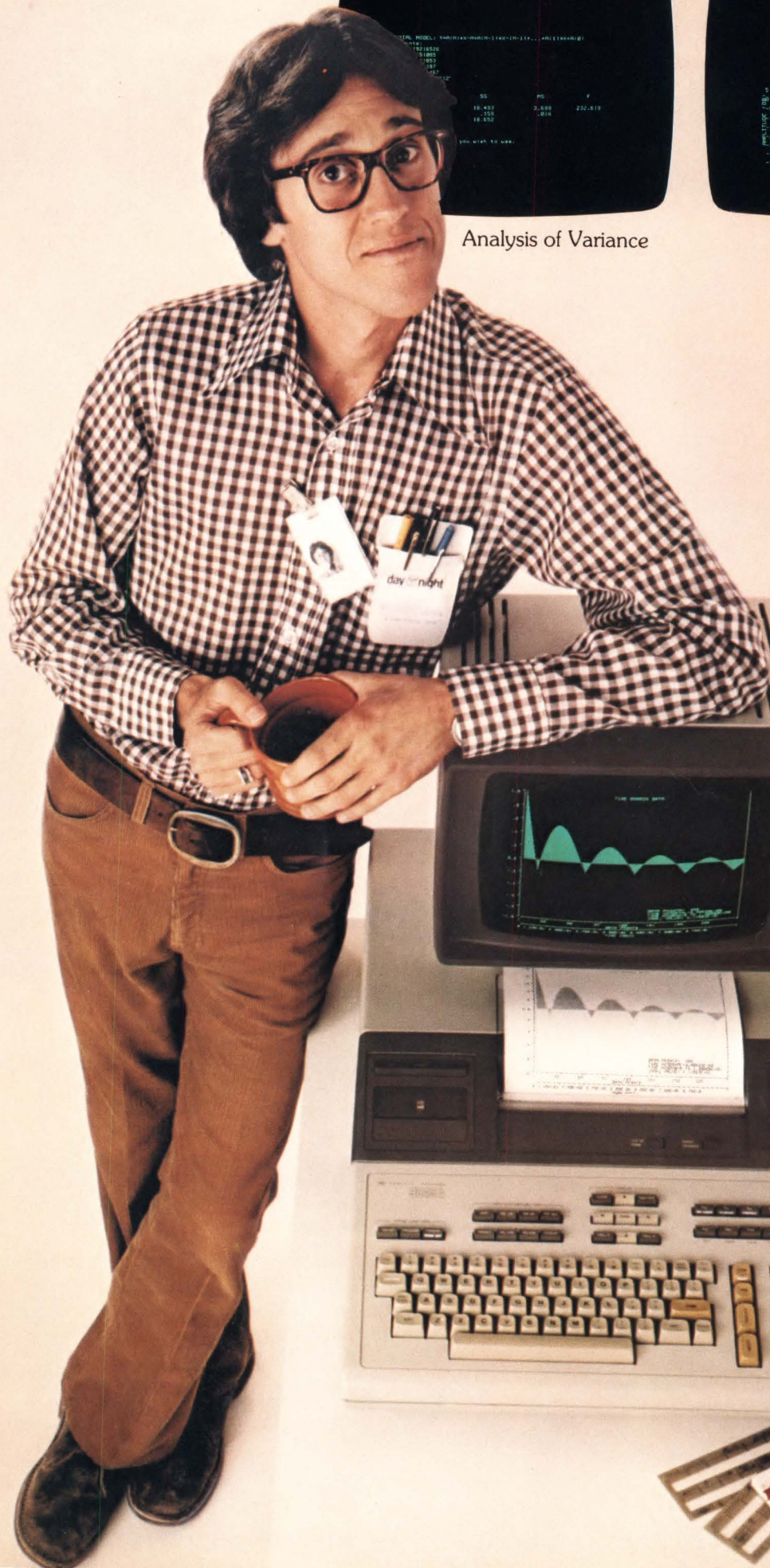

Analysis of Variance

Engineering Analysis & Schematics

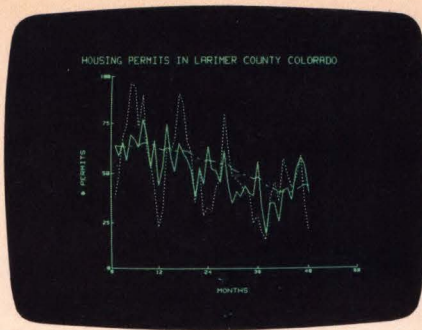

Time Series Analysis

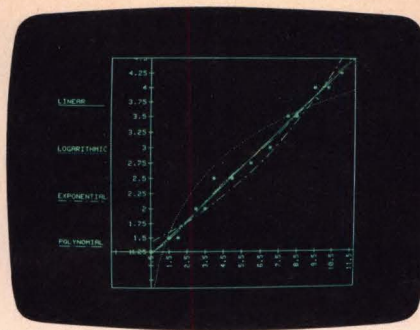

Regression Analysis

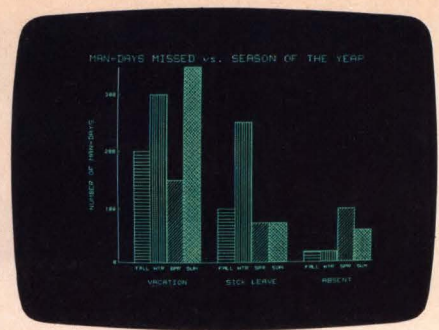

Business Analysis

With our new friendly computer, solving problems won't seem like work anymore.

Introducing System 45. Formally, it's called the HP System 45 Desktop Computer, but you'll come to regard it as a valuable friend. It fits in your workstation, ready to go the instant you have a problem. Gives you the ability to perform more thorough analyses, faster, and with less effort than you ever imagined.

System 45's friendliness comes from the integration of several problem-solving capabilities in one compact chassis. It puts powerful graphics, high performance I/O, big memory, and mass storage all together at your fingertips. Most important, System 45's design enables you to fully exploit these capabilities without getting involved in its internal operating routines.

The power to handle big tasks. Though small enough to go wherever your work demands, System 45 is big enough to handle 85 x 85 matrix inversions or tenth-

order ordinary differential equations. You can easily handle most of the problems you've been assigning to a big computer: Clin-lab data base management, thermal analysis, high-speed data acquisition and control, state variable analysis, structural analysis for virtually any geometry, production scheduling and control, or electronic circuit analysis—to name but a few.

Conversational Problem-solving. Solutions are straightforward because you communicate with System 45 in conversational BASIC. The dialog is so relaxed it seems almost human. Type in your data and commands and System 45 presents your formatted results on its high-resolution CRT. Need hard-copy? A single command exactly duplicates your plot, drawing or data table on the optional built-in printer.

A logical growth path. Like any true friend, System 45 will stick by you as your problems grow and change. You can expand the mem-

ory, add performance options, or plug-in your choice of peripherals, including floppy and hard discs. For more convenience and versatility, you can round out your system with a selection of programs from our growing software library.

Ask for an introduction. To learn more, drop us a line in Loveland, home of the friendly computers. Or call your local HP Sales Office for an introduction to the System 45.

Please have a salesman call. E12877
Phone _____

Please send more information.

My application interest is:

Engineering Design.

Numerical Analysis.

Data acquisition and control.

Name _____

Company _____

Address _____

City/State/Zip _____

P.O. Box 301, Loveland, Colorado 80537

HEWLETT  PACKARD

P.O. Box 301, Loveland, Colorado 80537

For assistance call: Washington (301) 948-6370, Chicago (312) 255-9800, Atlanta (404) 955-1500, Los Angeles (213) 877-1282

4077

Circle 59 on reader service card

THE WORLD'S MOST POWERFUL 16-BIT MICROCOMPUTER HAS A WHOLE NEW DIMENSION.

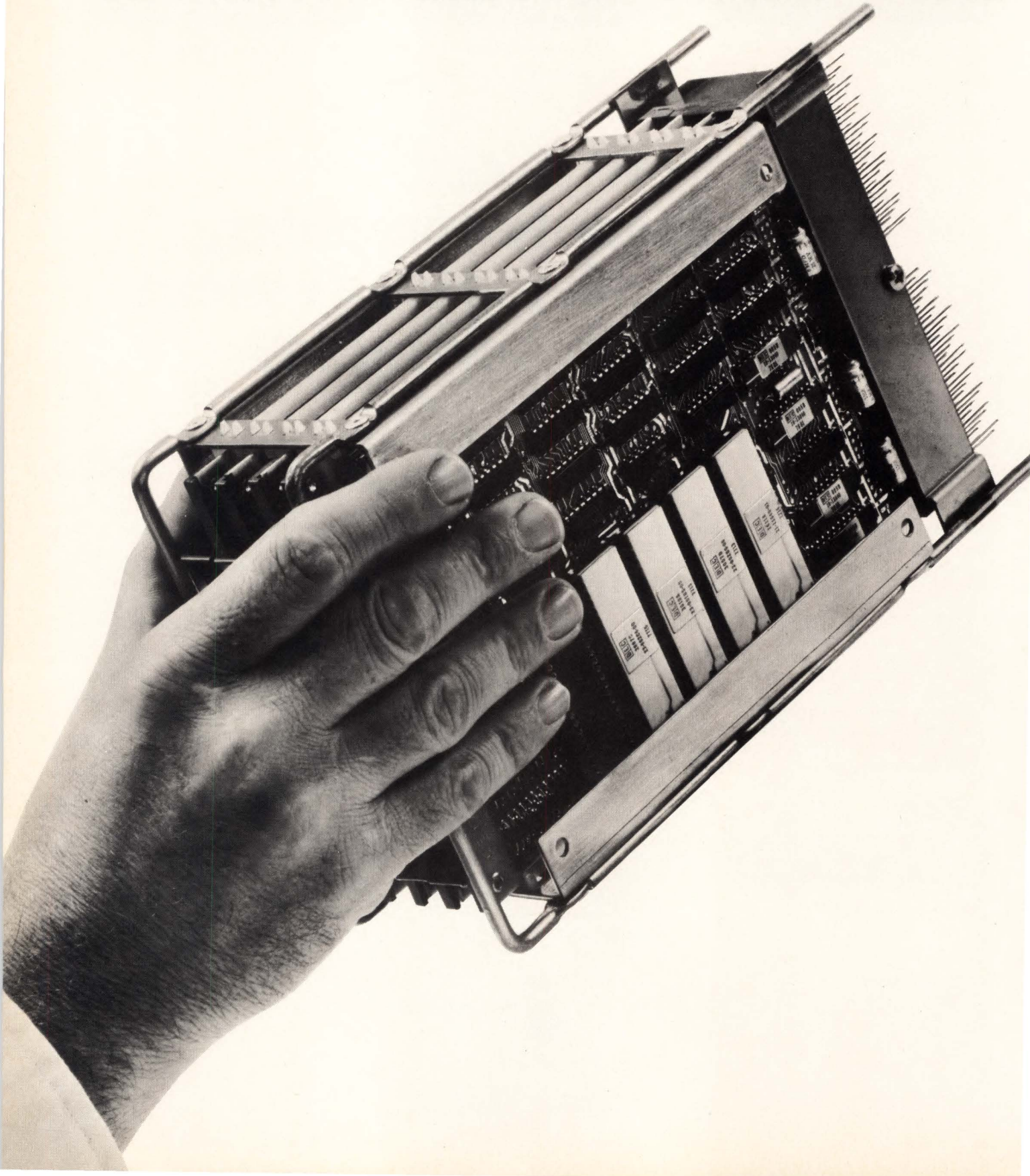

Introducing the LSI-11/2.

We've divided our LSI-11 board down the middle, so that CPU and memory are on separate, half-sized boards. What this gives you is a greatly improved form factor, for a new range of design flexibility.

And size is just the start. Your cost savings can be up to 40%, depending on configuration. And power consumption has been lowered, too.

We're also extending our half-size format to a whole new family of micro-computer options, including memories and interfaces.

Imagine: With just two 5" X 8½" boards in our new micro-backplane, you can have

a 16-bit system with up to 32K words of RAM, and room left over for your own electronics. That's a 67% reduction in space. And all for less than \$1650*.

Naturally, our entire half-size family is compatible with our previous products, to expand your options even further.

The LSI-11/2.

Full PDP-11 power — backed by over 50,000 installations — at a price and size that are both easier to handle.

To explore the possibilities, call toll-free 800-225-9220 (in Mass. 617-481-7400, Ext. 5144), or write Digital Equipment Corporation, One Iron Way, Marlborough, MA 01752.

*Quantity 50



digital
COMPONENTS
GROUP



Digital announces a PDP-8 with an enormous memory.

Something big has just happened to the world's most famous small computer. In fact, something enormous.

Digital has just put 128K of memory into the PDP-8.

This act is brought to you by a powerful new memory management option called KT8-A. And by two new MOS memory modules that fit large amounts of memory into small amounts of space. Simply by adding these 16K or 32K modules in whatever combination you choose, you now expand your PDP-8/A into something bigger. What's even better, you can mix MOS and core. And that means you can protect your program in non-volatile core while you expand your data base in MOS.

And thanks to the KT8-A all this memory is under new management. Not only does the KT8-A let you address up to 128K words of memory, but it also offers you memory relocation and memory protection, while asking little in operating system overhead so you get faster system performance.

What's the cost of these enormous advancements? That's the next attraction.

The new PDP-8A MOS memory models are available at prices that are as crowd-pleasing as their performance. For a 16K 8A205 you'll pay as little as \$3900 (quan. 1). 8A425 with 64K

is as low as \$11,000. And the top of the line 8A625 with 128K is yours for as little as \$18,050.

They're the new big-memory Eights from Digital. Step right up.

Large memories aren't our only new trick.

New hardware and software improvements are also in the PDP-8 spotlight.

The VK8-A is a new low cost PDP-8A option that provides high quality video output plus keyboard and printer interfaces. Video character generation uses a super-sharp 9x9 dot matrix for high resolution on single or multiple CRT monitors up to one thousand feet away.

Also new for PDP-8 users is MACREL/LINKER – a sophisticated assembler with MACRO facilities that lets you implement, expand and update your system faster while reducing software development time.

And last but not least there's DECNET 8 – a series of software protocols that let you

form your own PDP-8 network.

The PDP-8. Bigger. Smaller. And better than ever.

A short while ago, we made big news with DECstation 78. A low-end system that set new highs for ease of use and simplicity.

Now we're expanding the PDP-8 family up, as well as down, and that means new opportunities for OEMs and end-users alike. Look into what's happening with PDP-8s. Call your nearest Digital sales office today.

Or send the coupon to PDP-8 Marketing Communications, Digital Equipment Corporation, 129 Parker Street, PK3-1/M34, Maynard, Massachusetts 01754. European headquarters: 12, av. des Morgines, 1213 Petit-Lancy/Geneva. In Canada: Digital Equipment of Canada, Ltd.

digital

PDP-8 Marketing Communications
Digital Equipment Corporation, 129 Parker Street, PK3-1/M34,
Maynard, MA 01754

Please send additional information about the PDP-8 family.

Name _____ Title _____

Company _____

Address _____

City _____ State _____ Zip _____

Phone _____ OEM _____ End-User _____

Application _____

4-bit, one-chip micro- computers

Brainy enough
for anything
from TV games
to industrial
controls.



Block diagram of MN1400
with on-chip, 1024x8-bit ROM.

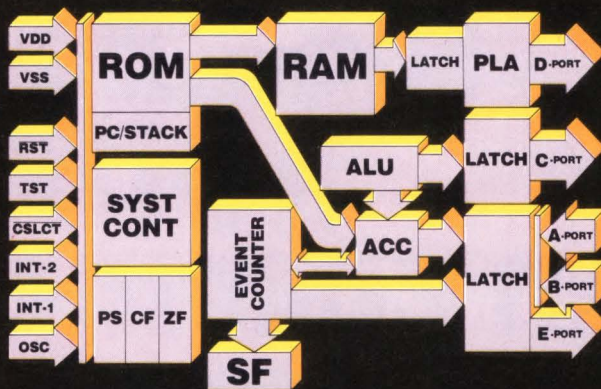

Now Panasonic offers you a whole family of TTL compatible, one-chip microcomputers. So you can choose the combination of features and capabilities that are most cost-effective for your application. From appliances to gas pumps and electronic scales, to copiers, POS and intelligent terminals, tractor controls and countless others.

Why pay for costly I/O interfacing when Panasonic puts it all on the chip?

Our MN1400 family is ideally suited for control functions with its extensive array of on-chip I/O facilities. There's an 8-bit presetable counter/timer, a clock generator, an arithmetic logic unit, and several input and output ports. Units are available with a self-contained 1024x8-bit ROM and a 64x4-bit RAM memory.

Still more flexibility and efficiency from Panasonic.

For flexibility, our instruction set contains up to 75 instructions. To give you TTL compatibility, all our family members operate on +5V. And for extra computing speed, we've utilized N-channel E/D MOS construction.

Panasonic can help you cut development time and costs.

Our Evaluator, the MN1499, can help you design, evaluate and debug programs quickly. In addition, software is available for a number of applications.

The Panasonic family of one-chip microcomputers.

Package	MN1400 40-Pin Plastic DIP	MN1402 28-Pin Plastic DIP	MN1498 40-Pin Plastic DIP	MN1499 64-Pin Ceramic DIP
Power Supply	+5V	+5V	+5V	+5V
Instruction Cycle Time	10 μ s	10 μ s	10 μ s	10 μ s
Instruction Set	75	57	68	75
Instruction Memory	Internal 1024 x 8 bits (8192 bits)	Internal 768 x 8 bits (6144 bits)	External 1024 x 8 bits (8192 bits)	External 2048 x 8 bits (16384 bits)
	Total on Chip RAM	64 x 4 bits (256 bits)	32 x 4 bits (128 bits)	64 x 4 bits (256 bits)

16-bit microprocessors, too.

They're ideally suited for a wide variety of computer peripheral and business machine applications. Designed with minicomputer architecture LOCOS MOS N-channel construction for optimum speed and thruput efficiency.

For complete information and prices, write to Panasonic Electronic Components, One Panasonic Way, Secaucus, N.J. 07094; or call (201) 348-7269.

Panasonic®
just slightly ahead of our time

Circle 64 on reader service card

LSI: the testing nightmare

Increasing complexity creates technological and cost problems and puts makers, users, and tester suppliers at cross purposes

by Bruce LeBoss, New York bureau manager

Makers of LSI testers must sometimes feel like laboratory rats being asked to run ever more complex mazes. And the large-scale integrated circuits now on the drawing board promise only to exacerbate the problem: they will be more complex and tougher to test.

As if that were not enough, there is also pressure on LSI vendors and users to keep testing costs in line with the plummeting selling prices of the devices, just as the price of LSI systems and software supports are climbing. Such pressure may mean that the sophisticated testers for screening and qualifying LSI circuits are not being used to their full capability, reducing the quality and reliability of the devices tested.

In effect, IC makers and users are pulling in the opposite direction from the tester makers. "The semiconductor industry, both manufacturers and users, have boxed themselves into a corner with LSI parts," says L. Lloyd Morgan, quality control manager at Qantel Corp. in Hayward, Calif., a maker of small business computers. "On one hand, the manufacturers rush to get new designs into the field as early as possible. Inevitably, that means some weak designs will reach the field. On the other hand, users demand such a low price that adequate testing by the manufacturer cannot possibly be performed."

Take the 4,096-bit random-access memory, says Morgan, who has seen failure rates in certain lots as high as 50% at incoming inspection. "The user, particularly a computer manufacturer, must ensure that bad 4-k RAMs do not reach the field." The concern is not over parts that go bad

but over parts that are bad from the beginning, and these, Morgan states, represent upwards of 1% of the 4-k RAMs being shipped.

He maintains that vendors use large dynamic test systems that can easily cost more than \$500,000 and try to justify their investment by rushing the RAMs through in large numbers, though the best tests take a relatively long time to complete.

"Vendors often test for only about four seconds," Morgan claims, "and often the only test is some variant of a 'march' pattern with some guardband conditions, so that all too many pattern-sensitive failures get right through." Since vendors sort the parts for access time, slow devices are removed. However, he continues, "it is a sad irony that very sophisticated, extremely complex memory test systems [such as those made by Tektronix Inc. and Teradyne Inc., among others], capable of running almost any pattern desired, end up being used in such a simple manner."

Darker future. But the problems of 4-k RAM testing may soon seem slight when compared with those of testing the newer, higher-speed 16,384-bit RAMs. With the delivery

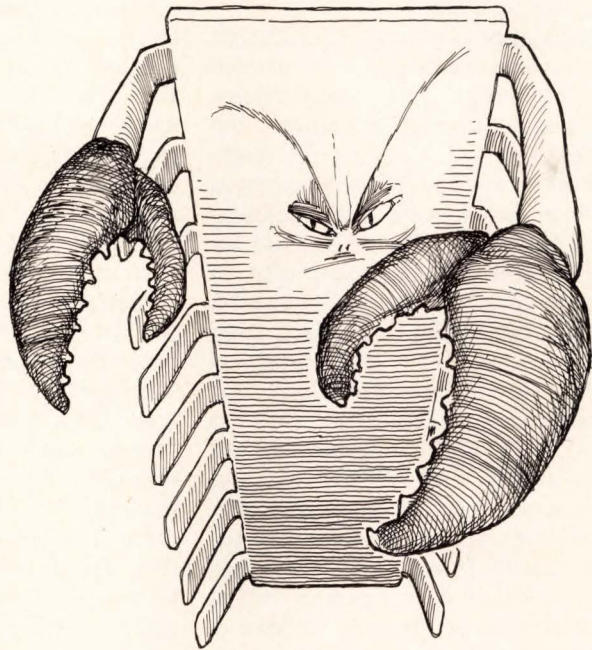

of these devices reaching higher volumes, "new and more complex problems are confronting both the device test engineer and the test-equipment supplier," says Jerry G. Taylor, memory products engineering manager at Mostek Corp. in Carrollton, Texas.

Most obviously, "test time considerations for production tests of 16-k devices can be extremely significant," he says, since many commonly used pattern-sensitivity tests vary in length as a function of the number of bits in the memory (n) by a factor of $n^{3/2}$ or n^2 . Thus, the test time penalties paid in moving from testing 4-k to 16-k RAMs can be as much as 16 times greater.

A second problem is caused by the higher speeds of 16-k RAMs, because "timing accuracies on presently available memory test equipment are

Probing the news

often not adequate," says Taylor. Thirdly, there is the power-supply and input/output noise during functional testing. Since the internal clocks of these devices operate at a higher speed, the current transients on the power supplies increase in magnitude and induce more noise than in slower devices. Also, the windows during which data is sampled become narrower on faster devices, Taylor notes, "enabling noise of short duration to have a more severe effect."

Reliability obstacles. Matters get worse when the devices are intended for high-reliability applications. "The specifications, techniques, and philosophies satisfactory for high-reliability discrete semiconductors as well as small-scale and medium-scale ICs are grossly inadequate for application to LSI, especially to microprocessors," says Lawrence M. Hess, group leader in the parts engineering group of Jet Propulsion Laboratory in Pasadena, Calif. "LSI devices are so complex that they are difficult, if not impossible, to test exhaustively, and industry has limited experience in testing them." Instruction sequence and data pattern sensitivities are known to exist, "yet, because it is virtually impossible to generate or even conceive of every possible pattern," he notes,

"these sensitivities cannot all be identified."

These qualification and screening problems are further compounded by the "lack of information about circuit architecture, schematics, logic diagrams, and other circuit data," Hess says. "By the time the logic diagram is released, the vendor probably has something else coming out of the mill." Also, manufacturers of microprocessors and other LSI devices "are inclined to limit testability so that chip reliability can't be verified," he points out.

However, much of the LSI testing problem centers around the test-system manufacturers. Hess observes that present equipment is designed to test MSI and SSI and has only been modified to accommodate LSI. "There also exists a total lack of commonality among test-equipment manufacturers and sometimes even among test-equipment lines of the same manufacturer," he says.

Maker's view. Regarding the microprocessor, Richard McCaskill, product manager at test-systems supplier Macrodata Corp. in Woodland Hills, Calif., says that today support chips present at least as serious a test problem. First, for each individual microprocessor, there are generally a minimum of five support chips, ranging from RAMS and read-only memories to universal asynchronous receiver/transmitters and disk con-

trollers. Second, McCaskill says, the support devices are not provided with unique instruction sets of their own. Therefore, software and hardware simulators or emulators will be time-consuming and costly to develop if the device is to be tested in its intended application. Last, the support chips are becoming more complex to test than the microprocessors, since they carry more and more of the external interface circuitry.

But the solution to the testing problems that confront LSI manufacturers may not be solved by the tester makers. Observes David Alvarez, Mostek's head of memory systems engineering: "We don't get the test equipment we need until the need goes away or we have the problem solved in house. Test-equipment manufacturers are behind the times." Further, while the digital features of today's test systems are very good, "their analog functions are incapable of coping with some of the faster parts we're going to have in the future," he notes.

LSI users also feel they are being left to fend for themselves in solving their testing problems. "I'm very often told about solutions to my problems, but nobody ever asks me what my problems are," says Phil Goldman, manager of memory test equipment at Digital Equipment Corp., Marlboro, Mass.

More complications. The testers raise their own problems. According to Steve Childress, manager of test engineering and maintenance at Intel Corp.'s Memory Components division in Santa Clara, Calif., the systems are so complex that "it takes 18 months to train people to handle just 60% of the test problem, and only a gifted few can handle 100% of the problem." The requirement for a lengthy training period, he notes, also lengthens system downtime.

But perhaps the greatest challenge to testing increasingly complex LSI is to hold testing costs in line. Macrodata product manager Roger Standridge points out that the market price of LSI devices in effect limits how much a manufacturer can spend on testing a part. Unless errors become prominent and users complain about quality and reliability, the LSI maker "has no incentive to produce better parts," he notes. □

Costs bedevil all sides

When all is said and done, the pacing factors in LSI device testing are economic: customers want more devices faster, so manufacturers simply give passing grades to more devices. That is what Carl Green means when he says that economic factors "force vendors to increase yields," and as a result, "manufacturers cut corners in their reliability assessment." Green is reliability manager for purchased products at Bell Laboratories in Allentown, Pa. While it is very difficult now to test LSI devices, Green thinks "further shrinking of the design rules will pose real problems." Moreover, "you can't depend on LSI manufacturers to defend you—they'd like to, but they can't afford to," he says.

Test-system manufacturers also hold out little hope that LSI testing costs can be held down. "The trend in microprocessor testing is toward more sophisticated and more expensive test equipment," notes James T. Healey, manager of the Fairchild Instrumentation and Systems unit in Wiesbaden, West Germany. Possibly this is so, he says, because programming and analysis of test data, rather than the test hardware, make up most of the cost—and while hardware costs go up linearly as device complexity increases, software costs go up exponentially. In fact, "it is not uncommon for programming costs to exceed the cost of hardware," adds Herbert Thaler, senior systems designer at Adar Associates Inc. of Burlington, Mass.

Intel delivers the only 16-pin 4K RAM that's sure to keep you smiling.

You may or may not think of your memory system as a masterpiece. But one thing is certain, once you've reached volume production you're going to be reluctant to make major changes. That's why it is so frustrating to find that a supplier has painted you into a corner by deciding to stop delivering the part you want. Or by trying to switch you to a newer, non-compatible part.

Smile. Our 2104A 16-pin 4K RAM is the answer. It's a direct replacement for both the older 4096 metal gate and newer 4027 silicon gate parts. The 2104A keeps your production line moving without expensive re-design. Plug it in and you're ready to go.

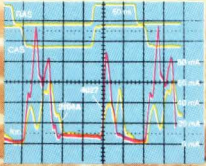

The 2104A is best for your new designs, too. We've been delivering this part in volume since July, 1976. So you can count on Intel to deliver the quantity you need, when you need it.

Delivery is not the only reason to specify the 2104A. There's not a 16-pin 4K RAM anywhere with lower power consumption. And because the 2104A has significantly lower current spikes

than other 16-pin 4K RAMs, there's less system noise. What it all means is that when you design your next system, it makes sense to design it using our 2104A.

	Maximum Access Time	Maximum Read/Write Cycle	Maximum IDD Average
2104A-1	150 ns	320 ns	35 mA
2104A-2	200 ns	320 ns	32 mA
2104A-3	250 ns	375 ns	30 mA
2104A-4	300 ns	425 ns	30 mA
2104A	350 ns	500 ns	30 mA

You can order the 2104A from distributor stock. Contact: Almac/Stroom, Component Specialties, Cramer, Hamilton/Avnet, Industrial Components, Pioneer, Sheridan, Wyle/Elmar, Wyle/Liberty or L.A. Varah. Or write us. Intel Corporation, 3065 Bowers Avenue, Santa Clara, CA 95051.

In Europe, Telex 24814, Brussels.
In Japan, Telex 28426, Tokyo.



intel® delivers.

Circle 67 on reader service card

AMP's new laminar system takes the bulk out of board-to-board connectors. And puts tin-to-tin economy in.

Now, from AMP engineering research, comes a different concept in board-to-board connectors—the economical laminar interconnect system. It utilizes flame retardant insulating film which substantially reduces housing size, weight and cost, yet maintains contact insulation and protection.

The new system increases packaging versatility. Contacts are available which enable boards to be interconnected at any angle and in various combinations. The tin plated, clip-shaped contacts engage both sides of a board and can be used on all four edges.

AMP laminar connectors can also improve reliability. The deflection designed into the contact assures good electrical connection for virtually any pc board thickness as well as for warped or bowed boards. And when you need extra ruggedness and protection, simple auxiliary plastic housings are available.

There are more features you'll like about AMP's unique laminar board-to-board interconnect system including AMP engineering backup all along the line, whenever you need it. So why not put them all to work for your product.

For a free test sample, just call (717) 564-0100 Ext. 8400, TELEX 510-657-4110, or write us on your company letterhead. AMP Incorporated, Harrisburg, PA 17105.

AMP has a better way.

Circle 68 on reader service card

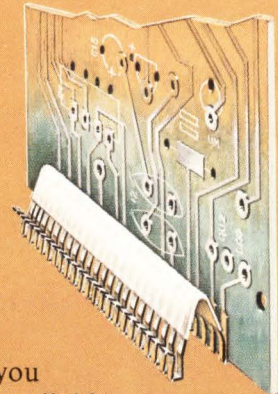

AMP
INCORPORATED

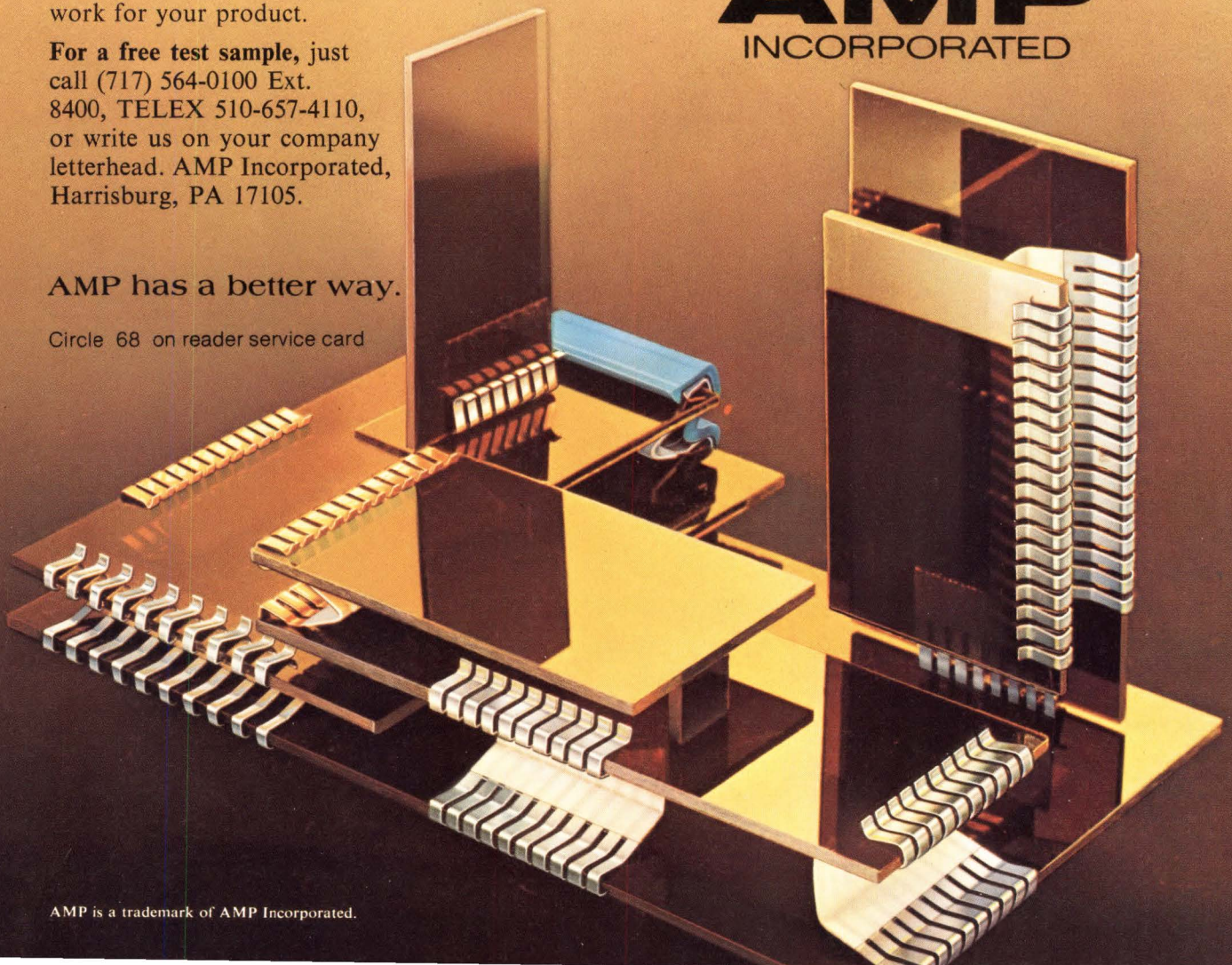

Electronics abroad

West German predictions fall short

So for next year, with GNP expected to rise merely 3%, forecasters see only 5% increase in overall domestic electronics sales

by John Gosch, Frankfurt bureau manager

The way the year has turned out, West German business forecasters might well think of swapping their econometric models for tarot cards, dart boards, or crystal balls. Twelve months ago, for example, most of them foresaw growth of 8% during 1977 for domestic sales of electronics equipment, and some were even talking about 10%. But the actual figure will be closer to 5%, according to *Electronics*' annual fall survey. In fact, had it not been for a relatively good showing by computer makers and a comeback of sorts in the fall by consumer-electronics suppliers, 1977 would not have been even that good.

So it is not hard to see why forecasters currently are cautious. Few think that the multibillion dollars that chancellor Helmut Schmidt's coalition government plans to distribute to stimulate the economy can have much impact on growth before 1979. As a result, the rise in the gross national product next year figures to run some 3%, the same as this year. That is meager, as growth goes, and points to a sober 1978 for the country's electronics markets. The survey puts total equipment markets next year at \$8.75 billion, up some 7% from 1977's \$8.14 billion. As for components markets, they are forecast to edge up 5% to \$2.55 billion. (Dollar figures are based on the current exchange rate: \$1 = 2.25 Deutsche marks.)

Some bright spots. It could be worse. Some of the rise will come from sectors that have been sluggish in the past. "After years of keeping its purse strings tight, the post office will be spending more next year," says Manfred Beinder, chief econo-

mist at ITT's Standard Elektrik Lorenz AG in Stuttgart. That, together with new business from industry, should add up to "nice growth," for communications equipment, Beinder expects.

Computer makers, apparently, can now count on business they ordinarily would have had in the mid-1970s, when their customers turned balky, waiting for better times. "More and more customers are buying or renting equipment they wanted to have much earlier," says Jochen Rössner, a marketing man at Sperry Univac. As for test and measuring instruments, "the trend is positive again after a rather dull 1977," says Jürgen Buesen, a marketing expert at Hewlett-Packard GmbH in Frankfurt.

However, past prosperity will not help other sectors. Industrial elec-

tronics makers—who enjoyed boom years not long ago—cannot expect much of a sales increase in 1978. Also, business in medical electronics equipment, which used to soar 25% annually and more, will at best be fair to middling next year, because federal and local governments are determined to slash spending for health and welfare.

Soft sector. Nor can entertainment electronics producers look forward to the growth rates of yesteryear. "The 10% push from the overall consumer sector this year may drop to 5% in 1978," says Hanno Gauger, director of sales and marketing policy at Siemens AG. That is because no one can see how 1978 could be a big color TV year. For one thing, after 10 years of color telecasting, the market is mature—one out of two of West Germany's

WEST GERMAN ELECTRONICS MARKETS FORECAST
(IN MILLIONS OF DOLLARS)

	1976	1977	1978
Total assembled equipment	7,695	8,140	9,753
Consumer electronics	2,940	3,019	3,067
Communications equipment	1,266	1,339	1,504
Computers and related hardware	2,262	2,455	2,784
Industrial electronics	522	549	565
Medical electronics	459	510	536
Test and measurement equipment	165	182	205
Power supplies	81	86	92
Total components	2,221	2,420	2,554
Passives	994	1,076	1,140
Semiconductors	645	740	808
Tubes	582	604	606

(Exchange rate: \$1 = 2.25 Deutsche marks)

Note: Estimates in this chart are consensus estimates of consumption of electronic equipment obtained from a survey made by *Electronics* magazine in September and October 1977. Domestic hardware is valued at factory sales prices and imports at landed costs.

Thin-Trim[®] capacitors



 Tucked in the corner of this Pulsar Watch is a miniature capacitor which is used to trim the crystal. This Thin-Trim capacitor is one of our 9410 series, has an adjustment range of 7 to 45 pf., and is .200" x .200" x .050" thick. The Thin-Trim concept provides a variable device to replace fixed tuning techniques and cut-and-try methods of adjustment. Thin-Trim capacitors are available in a variety of lead configurations making them very easy to mount.

 A smaller version of the 9410 is the 9402 series with a maximum capacitance value of 25 pf. These are perfect for applications in sub-miniature circuits such as ladies electronic wrist watches and phased array MIC's.

Johanson Manufacturing Corporation,
Rockaway Valley Road., Boonton, N.J.
07005. Phone (201) 334-2676, TWX 710-
987-8367.

Johanson

MANUFACTURING CORPORATION

70 Circle 70 on reader service card

Probing the news

23.2 million households has a color set. For another, wage-earners presumably will spend their Deutsche marks carefully with nearly 1 million unemployed, a shocking figure for Germany.

So forecasts for West German color TV sales are understandably flat. Wieland A. Liebler, head of market research at Saba-Werke GmbH, predicts a rise from 2.6 million sets this year to 2.76 million next. Johanna von Ronai-Horvath, a market specialist at the ITT entertainment electronics companies Schaub-Lorenz GmbH and Graetz GmbH, comes in a little lower. Her prediction: 2.55 million this year versus 2.68 million in 1978. Hamburg-based Philips GmbH forecasts a 2% growth, to 2.35 million sets.

Japanese success. Actually, more worrying than mature color TV markets is the success in West Germany of Japanese suppliers, whose sales figures for portable TV sets and high-fidelity equipment are rising spectacularly. Nonetheless, the magnitude of West German consumer electronics sales remains impressive, with slightly more than \$3 billion forecast for 1978.

Computer makers logged good sales this year and should score double-digit advances in 1978 as their markets continue to recover from the 1974-75 setback. *Electronics'* survey forecasts an overall data-processing equipment market of \$2.78 billion, up 13% from this year's estimated \$2.46 billion.

Satisfying pent-up computer demand will not be the only market stimulant next year. Small and medium-size firms are turning increasingly to computers, and the systems suppliers are responding with distributed-processing systems that put computer power right where it is needed—at the operations center of the business. No wonder, then, that the steepest rise is predicted for intelligent terminals, data-collection systems, and office computers—equipment that is usually priced at up to \$110,000.

Communications equipment makers, too, after several lean years, can look forward to solid growth, pro-

moted in good part by more orders from their traditional big buyer, the post office. The agency will boost its spending by about 11%—from \$2.7 billion this year to slightly more than \$3 billion in 1978.

Most of the post office investments next year will be for communications hardware, with a substantial amount of that for electronics equipment. A major reason for growth in the communications sector is that, at long last, electronic exchanges have become a market factor, says Standard Elektrik Lorenz's Beinder. Siemens, SEL, Telefonbau und Normalzeit, and Deutsche Telefonwerke all have the EWS switching system in production.

Still another program that has finally begun to generate a fair amount of business is the EDS electronic data-switching system developed by SEL and Siemens. The post office, which aided in the development, will shell out more than \$570 million for EDS production and installation in the early 1980s.

Spare parts outlook. As for components makers, their order books generally wax and wane in large measure according to the outlook for TV set makers. Therefore, unless an inexplicable urge to buy consumer goods develops early next year (and so far no one expects that to happen), the parts people have to expect a lean year. Some companies can see no more than a rise of 4% in sight for the market. Others have based their planning on something like 9% or a little more. *Electronics'* survey points to components markets of \$2.55 billion next year, up 5% over this year's mark.

It is the kind of situation that makes semiconductor makers jittery. "We are up against a price war," says Dirk G. Vogler, manager of marketing administration at Texas Instruments GmbH, "and it's tough to compensate for declining prices by selling more devices." Fritz G. Höhne, manager of worldwide semiconductor marketing at AEG-Telefunken, sees it pretty much the same. Also, the short-term commitments that set manufacturers make for deliveries "keeps us from planning ahead," he explains. □

First in a series examining European markets.

RCA first in CMOS.

Full-temperature protection at low ceramic prices.

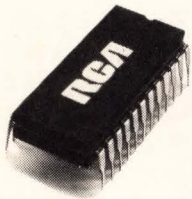

You can add the extra protection of full temperature operation to your B-Series CMOS designs. Without adding to your frit-seal costs.

How? With RCA's frit-seal ceramic package. It offers -55° to $+125^{\circ}\text{C}$ ratings at the same price levels other CMOS manufacturers are publishing for frit-seal product with limited temperature ratings.

What's more, RCA frit-seal ceramic COS/MOS-B is readily available. Most types are on your Distributor shelves. You can order it just by asking for suffix "F."

- **First in CMOS logic.** RCA created the industry standard 4000A-Series and has led the way ever since. And introduced the first high-voltage CMOS circuit.
- **First in CMOS microprocessors.** The RCA 1800 family combines elegant 8-bit COSMAC architecture with CMOS benefits. Result: outstanding performance plus maximum flexibility with minimum parts count.
- **200,000,000th unit.** RCA COS/MOS production capacity has doubled in the last six months and we expect to manufacture our 200,000,000th COS/MOS unit this year.

To fill your needs in CMOS, call your RCA Solid State distributor. Or contact RCA Solid State headquarters in Somerville, NJ; Sunbury-on-Thames, Middlesex, England; Quickborn 2085, W. Germany; Ste.-Anne-de-Bellevue, Quebec, Canada; Sao Paulo, Brazil; Tokyo, Japan.

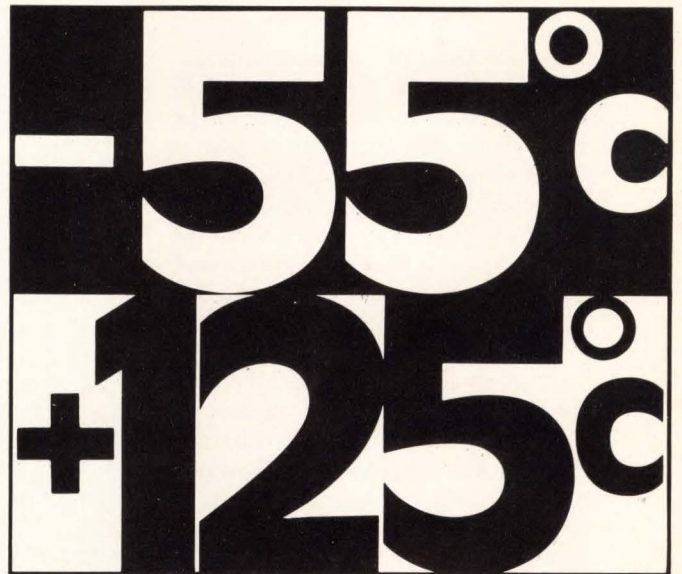

When you say CMOS, say RCA first.

Electronics abroad

Did U. S. push Japanese imports?

Yes, argues H. William Tanaka, Washington lawyer for EIA-J,
citing citizens' band and transistor radios as examples

How American electronics manufacturers and their Government feel about Japan's soaring exports to the U. S. gets a big press. So to give a Japanese perspective, *Electronics* interviewed Washington attorney H. William Tanaka, an American whose firm of Tanaka Walders and Ritger numbers the Electronic Industries Association of Japan among its clients.

As he says, he is "not a spokesman for EIA-J," since his firm represents EIA-J "only on a case-by-case basis." But the Los Angeles-born Tanaka's articulate representation of what he calls "the other side of the equation" in ongoing Japanese-American electronics trade issues has gained him the respect of those he deals with in U. S. government and industry.

Seated near a Sanyo color TV receiver in a conference room of his Washington offices, Tanaka answered a series of questions from Ray Connolly, *Electronics* Washington bureau chief:

Q. How do you respond to U. S. criticisms being made against Japanese takeovers of its electronics markets?

A. I think that Japanese competition has been stiff, but I also think that the problem is not really imports but, rather, is related to demand. Obviously, there is an American demand being satisfied by imports. Increasingly, you cannot assert that price is the only consideration to affect the level of import trade from Japan. Quality, availability, and sourcing problems all have a role in demand. Fundamentally, the question is whether there is a production-push on exports from Japan, or a demand-pull on imports from Japan. A demand-pull increase in imports is



The other side. Washington attorney H. William Tanaka says Japanese import thrust has been encouraged partly by U. S. firms.

not fundamentally an import problem. The Japanese position probably is that we have been examining only one side of the equation in this country—the import side into the U. S.—and looking at a statistical analysis of bilateral trade and saying, "The Japanese are taking over our market." The other side of the equation is: what role does demand in the U. S. play in inducing imports from Japan?

Q. To what do you attribute the role of "demand-pull?"

A. There are a number of reasons. Procurement policies and multinationalization by American assemblers both play huge roles. Import problems are not necessarily a phenomenon caused entirely by Japanese-investor-owned companies. For example, we see Howard Cosell

advertising General Electric Co. citizens' band radios. We all know that the entire GE line is imported from Japan. If we are to say that CB radio imports are a problem, are the Japanese responsible? Or is GE in part responsible? Is this a demand-produced import or a production-pushed export? That, it seems to me, puts the thing in proper perspective. We need to look at both sides of the equation.

Q. Is there more to "the other side of the equation?"

A. There are other issues beyond those that the U. S. industry attacks—unfair trade practices, for example, or that cheap prices or labor costs or Japanese government subsidies are by themselves the sole factors. Take a look at research and development. In any of the involved areas, the specter of the Japanese government carefully financing every aspect of the electronics industries to make them competitive and ultimately take over U. S. markets does not really hold water. If you look at the principal U. S. exports such as jet engines, aircraft, military hardware, and weapons, all of them have been developed at one point or another through U. S. spending on defense or space programs.

Look at the semiconductor which was developed by Bell Laboratories in 1947. Was that developed by private R&D spending? It was developed by Government R&D spending through Bell Labs. So even in semis—one of the most technology-intensive of U. S. exports—you find that Government R&D spending had something to do with it. When you look at major U. S. export items, including computers, you find that if

NOW



A magnetic circuit breaker that proves

LESS is MORE!



Airpax T11 Snap-Action Magnetic Circuit Breaker.

The Airpax T11 is a single pole, single throw, series trip magnetic circuit breaker that combines power switching and accurate, reliable protection in one aesthetically pleasing package. It features a patented snap-action that assures immediate and positive opening or closing of the contacts. This snap-action results in an increase in operational life of up to 5 times that previously available. It also eliminates possible operator "teasing" of the contacts and minimizes arcing.

LESS COST. The T11 costs less than any other magnetic circuit breaker on the market today . . . under \$5.00 in small quantities. Even less as the quantity increases. And the traditional Airpax Five-year warranty.
Result: MORE protection for your money.

LESS SPACE. The T11 combines power switching and current protection in one tiny package about 1 cubic inch in size. That's smaller than any other magnetic breaker. In addition, the T11 offers a choice of six attractive paddle handle colors and a variety of mounting hardware.
Result: MORE design flexibility.

LESS INSTALLATION COST. The T11 does the job of a power switch, fuse and fuse holder— all in one easy-to-mount unit. This

means only one item to be installed instead of three, less assembly time, and one-third the inventory.

Result: MORE Productivity . . . and profit . . . for you.

LESS SERVICE REQUIRED. The T11 is immediately resettable to check if a fault has been removed. There's nothing to burn out. Nothing to replace. No annoying service calls.

Result: MORE happy customers for you.

LESS GUESSWORK. Airpax has a bulletin fully describing the T11 snap-action magnetic circuit breaker, including rating, delays,

complete specifications, and a handy how-to-order chart.

Result: MORE information for you.

To get your bulletin, call your local Airpax representative or contact Airpax Electronics, Cambridge Division, Cambridge, MD 21613. Phone: (301) 228-4600. Telex: 8-7715. TWX: 865-9655. Other factories in Europe and Japan.

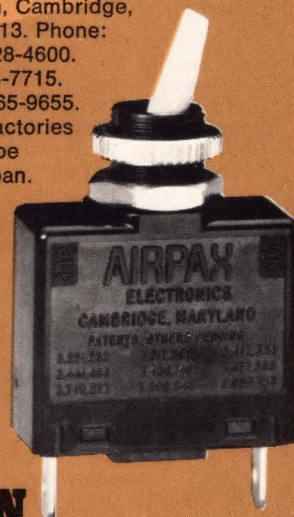

AIRPAX™

THE PRO IN PROTECTION

Tested for Millions of Operations

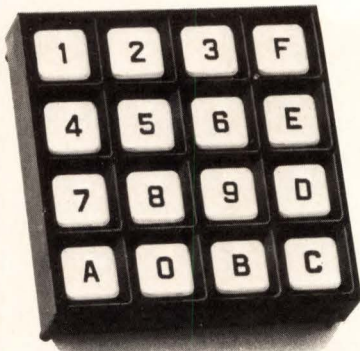

Grayhill 12 and 16 Button Keyboard Pads

choice of circuitry

- XY matrix
 - single pole/common bus
 - 2 out of 7 (or 8) coded output
- choice of 1/2-inch or 3/4-inch button centers

Grayhill's 3 x 4 Keyboard Pads earned instant popularity for their positive tactile and audio feedback and performance. Now the line is broadened by the addition of 4 x 4 Keyboards, featuring the same low profile, patented snap-action dome contact, and 3 million operation per button contact system life-rating. Readily interfaced with logic circuitry. Total button travel of only .015 inch. Standard post or flange mounting; top or sub panel mounting. Molded of tough ABS plastic; buttons with black on white molded-in legends a standard, other legend options available, including clear snap-on caps for user legending. Send for complete specifications, truth table, and information about our full line of Keyboard products, from Grayhill, Inc., 561 Hillgrove, La Grange, Illinois 60525. (312) 354-1040



Probing the news

R&D is not currently being funded in part by the Federal government those industries generally did develop with Federal government funding.

Q. But aren't American manufacturers responding only to their Government's "national needs," while in Japan, R&D money is often channeled to products specifically for export, like consumer electronics?

A. Sure, but the main point is this: we do have massive funding of certain national-security-related technology, and industry says any benefit that may rebound to the commercial, industrial, or consumer product sections is only incidental. It seems to me that whether the benefit is incidental or not is immaterial. The benefit is bestowed nonetheless.

We went into Japan [at the conclusion of World War II] and were concerned with making them the Swiss of the Orient, an unarmed Japan under the U. S. nuclear umbrella. Therefore, Japan doesn't have a national defense industry which it must fund as such; there can be no fallout from military R&D funding that might accrue to the commercial-industrial sector.

Q. Who is to blame, then?

A. In the consumer electronics area particularly, many of the problems are demand-related, in that American manufacturers have eschewed the markets going all the way back to transistor radios. This is what I call default of product competition. There wasn't any. It is a failure to understand and meet what the consumers desire.

Q. Do you see a similar situation today in video tape recorders?

A. Yes. The VTR is another example. It is default of competition. There is a demand, and there is a U. S. failure to recognize the demand and [a tendency] to look only at a new market in terms of what is good for the company in the short term.

Q. Do you see management as a U. S. problem?

A. Let me say there has been a considerable misperception in the U. S. of what would sell. It is a misperception of management policy, a failure to develop or occupy a

market quickly. Again, take CB radios. The Federal Communications Commission authorized the 27-megahertz channel back in 1958, and all during that time the major U. S. manufacturer was E. F. Johnson Co. Motorola had the technical capability and certainly the financial wherewithal to get into this market. It didn't get in. RCA didn't get in. GE did not get in. So a tiny company like E. F. Johnson was accounting for 85% of domestic production. Motorola still imports part of its line, and is just getting in since the market mushroomed. RCA continues to import, GE continues to import their equipment.

This is a default of competition making a deliberate decision not to produce. It is a make-or-buy decision where they decided to buy instead of make because they can use their financial resources to make a greater rate of return elsewhere. This is what it amounts to in a multi-product company of large size, like GE or RCA.

Q. How much of the import problem do you attribute to the fact that America is not fundamentally a trading nation like Japan?

A. A great deal, but there are at least two specific observations that can be made. First, the domestic U. S. market is so huge that most U. S. producers tend to think in terms of the domestic market, period. Two, to the extent that overseas markets are deemed to be profitable by U. S. companies, our multinational style of operation is not to manufacture and export from this country. Rather, we finance the establishment of manufacturing facilities in the particular national markets where we have an interest. Thus, how we develop foreign markets does not generate exports except perhaps initially in capital equipment like machine tools.

A third reason is that, unlike the Japanese, U. S. companies are not interested in manufacturing for export if management does not want to produce a custom-specified product for a given foreign market. They like to produce a product whose specifications are acceptable to the home market. For export, they are likely to say to you, "Here it is—take it or leave it." □

Kiss complexity goodbye with the coupler that acts like a Triac.

Simplify, brother, simplify, with Motorola's new, volume produced, optically-coupled Triac driver—the MOC3010/11.

Now you have a production-house coupler capable of interfacing fragile logic or MPU with Triac-controlled AC loads easily, quickly, directly.

Simple, but neat

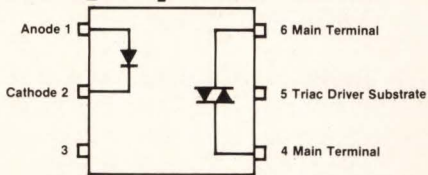

MOC3010/11s are GaAs IREDS optically coupled to monolithic Annular* silicon-nitride, ion-implanted detector chips with high voltage and bidirectional characteristics. The detector functions like a small Triac generating signals to drive gates of larger devices.

Just 10 mA to the LED latches on the detector until output drops below holding current. When the detector's off it blocks at least 250 V in either direction and, when on, conducts up to 100 mA with less than 3 V drop—more than enough to trigger most any power Triac.

At the same time it provides complete isolation of driving circuitry from noisy power lines with no bridges, diodes or whatnot to clutter and cost.

7,500 big ones

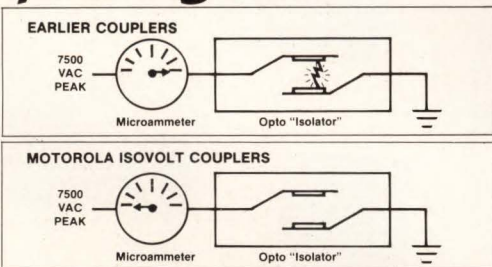

Early couplers were no match for really severe transients, randomly failing anywhere from 500 V up. But the MOC3010/11s are. To 7,500 V!

In fact, we test each and every one of our 500 to 5,000 V-rated couplers and Triac drivers to 7.5 kV peak between input and output without damage or

MPU OR LOGIC

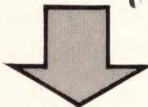
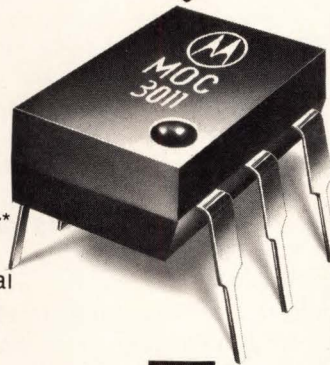

TRIAC



LAMP
RESISTIVE LOAD
INDUCTIVE LOAD
AC LOAD
240 V LOAD
APPLIANCE
S.S. RELAY
LV LOAD
REMOTE LOAD



deterioration . . . more than enough to keep trouble out of interface and coupling, phase and feedback, relays and switching. It's spec'd on the data sheet and you don't pay a cent extra for test or performance.

Alone or with others

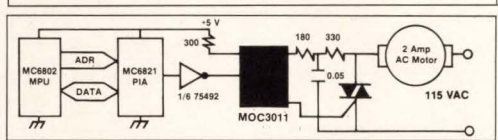

It's great for control functions. Since it functions like a small Triac, the MOC3010/11 can drive small loads . . . about 7-1/2 W in the 0°C to 70°C ambient range—warning lamps, alarms, displays, etc., withstanding surges to 1.2 A.

Where it really shines is driving big loads through Triacs—resistive incandescents and heaters—inductive motors and solenoids—with a new low in componentry and cost.

You can control 240 V loads by stacking two units.

And economical, remote AC power control over inexpensive, low-voltage lines, less subject to stringent local electrical codes, is now reality.

A hundred Lincolns for a Cadillac

Even though we've got a corner on it now, we know others will soon copy this state-of-the-art coupler. So we've made the price as hard-to-beat as possible—one buck for the MOC3011, 1K-up. You Win. We win.

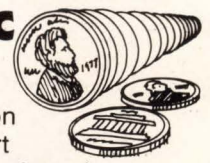

Triac Driver	V _{ISO} V	Trigger Current (Typ) mA	I _R (Typ) mA
MOC3010	7,500	8	0.05
MOC3011	7,500	5	0.05

See your authorized Motorola distributor for parts, buss the reader number for data. You'll love it. Motorola Semiconductor Products Inc., P.O. Box 20912, Phoenix, Arizona 85036, (602) 244-4306. (*Patented Process Motorola Inc.)



MOTOROLA Semiconductors

The mind to imagine... the skill to do.

Make the switch to Fujitsu high

When it's time to put solid "switching power" into your equipment, it pays to select relays with proven performance and top quality. And that's just what you get when you specify Fujitsu relays. The wide-coverage Fujitsu relay lineup is here now ready to fill your total relay needs, from space-saving flat package units to powerful 10-amp general purpose models. Each and every Fujitsu relay is built to the quality standards that are synonymous with the name Fujitsu, and all feature proven performance that guarantees thousands of hours of failure-free operation. Here are just some of the features in store for you when you choose the name Fujitsu for your demanding relay needs.

Fujitsu flat package relays

The Fujitsu lineup of flat package relays offers exceptional coverage and the advantages of flux-contamination-immunity. Within the lineup are our FRL 410-series low-profile and our BR-series miniature GP models. The former are available in both DPDT and 4PDT contact arrangements and coil voltage ratings to 48V DC, enabling the widest selection to meet demanding applications including those for communications. And our BR-series models offer you similar wide choice including 0.5A ultra-miniature models that enable exceptional component densities for solid savings in both equipment size and cost.

Fujitsu general-purpose relays

With a wide model choice, including units capable of handling loads to 10 amps, the Fujitsu general-purpose relay lineup is a winner. Most models are available in both DC- and AC-rated coils, and with a solid selection of mounting configurations. You also get solid load handling and a choice of contact material to meet your exact operation requirements. Contact arrangements available are from SPDT to 6PDT, depending on models, with 12PDT or 18PST available on special order with our 491-series miniature models. Yes, whether compact or high load, the Fujitsu GP relay lineup is solid to meet your total switching needs. And for special applications, Fujitsu relays with fixed, knob-adjustable, or driver adjustable time delay are also available.

Fujitsu reed relays

Featuring Fujitsu-built reed switches of exceptional quality, the Fujitsu reed relay lineup is the unbeatable choice for today's high-speed, low current switching applications. As standard features,

you get low contact resistance, compact size, a wide choice of contact arrangements and coil ratings, the availability of shielding and other features, and models including a built-in latching function via the Fujitsu MEMOREED® switch. You even have a choice of mounting grid patterns when you pick the FRL 640-series, low-profile reed switches. Full-featured and available in a wide range of models, Fujitsu reed relays are the solid choice for today's demanding data processing and control applications.

Fujitsu mercury wetted-contact relays

Built to provide exceptional reliability for a variety of equipment applications, Fujitsu mercury wetted-contact relays are top performers. Among the

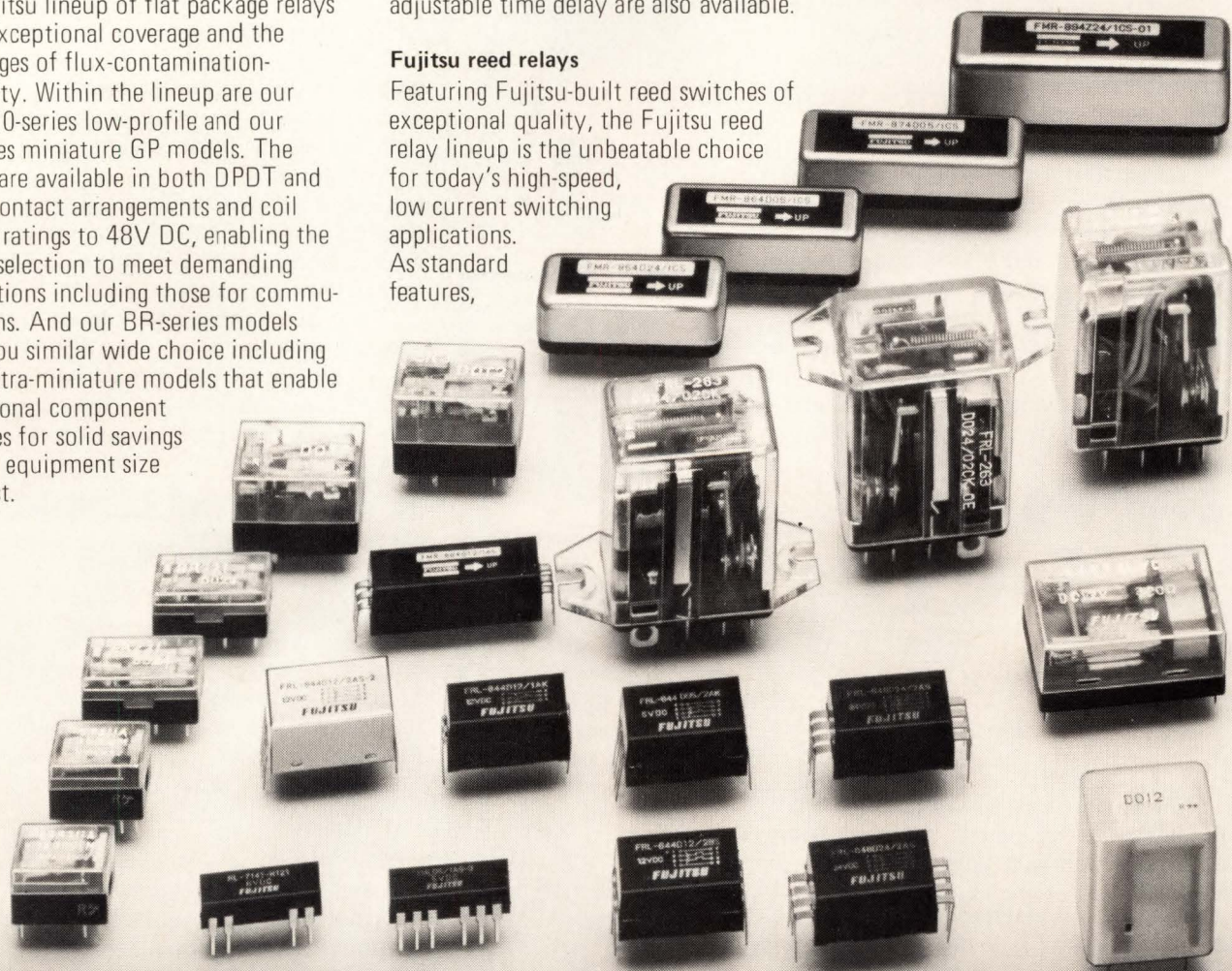

FUJITSU LIMITED
Communications and Electronics

FUJITSU AMERICA INC./Chicago Office: 910 Sherwood Drive--23, Lake Bluff, ILL 60044, U.S.A.
Phone: 312-295-2610 TWX: 910 651 2259

FUJITSU LIMITED/Components Group (Head Office): Syuwa Onarimon Bldg., 1-1, Shinbashi
6-chome, Minato-ku, Tokyo 105, Japan Phone: 03-437-2111 Cable: FUJITSULIMITED TOKYO
Telex: 2424511 FT SIN J Paris Liaison Office: Porte No.207, 1 Voie, Felix, Eboue 94000, Creteil,
France Phone: 01-898+03+55 Telex: 42-212544F

Circle 77 on reader service card

quality relays

advantages of our mercury wetted-contact models are freedom from contact bounce, low and stable contact resistance, wide load-handling capabilities (from micro-ampere levels to a full 2 amps), low unit profile, and the capability for being driven by ICs. In our five-model lineup, you can choose coil ratings to 24V DC, with all models guaranteeing at least 10×10^9 operations.

The Fujitsu relay lineup. It's full coverage and high quality for unbeatable performance, and at prices that will make you wonder why you didn't think Fujitsu before. So, join the growing number of makers who specify Fujitsu quality products. Call or write now for additional information. You'll be glad you did.



U.S./Canadian Sales Representatives

Application Specialists, Inc.
6806 Newbrook Ave., E. Syracuse,
NY 13067
Phone: 315-437-2813 Telex: 937201
3700 East Ave., Rochester,
NY 14618
Phone: 716-586-6226 Telex: 978367
3871 Harlem Rd., Suite 212,
Buffalo, NY 14215
Phone: 716-834-3377/8 Telex: 91586

Electrical Components, Inc.
Box 172, Natick, MA 01760
Phone: 617-655-2225 Telex: 948437
57 Dennis Rd., Longmeadow,
MA 01106
Beach Rd., P.O. Box 446,
East Orleans, MA 02643

Hughes Associates, Inc.
717 Pratt Ave., N.E., Box 33,
Huntsville, AL 35801
Phone: 205-536-2127

Gillum Sales, Inc.
P.O. Box 1915, Morristown,
TENN 37814
Phone: 615-587-2770

"C" Associates, Inc.
2500 Hollywood Blvd., Hollywood,
FLA 33020
Phone: 305-922-6230
249 Maitland Ave., Suite 317,
Altamonte Centre, Altamonte
Springs, FLA 32701
Phone: 305-831-1717

Bransky Sales
1279 Lincoln Ave., South
Highland Park, ILL 60035
Phone: 312-433-2375

McFadden Sales, Inc.
4645 Executive Dr., Columbus,
OH 43220
Phone: 614-459-1280
TWX: 810-482-1623

Technical Representatives, Inc.
6515 E. 82nd St., Suite 110,
Indianapolis, IND 46250
Phone: 317-849-6454
TWX: 810-260-1792
820 Spring St., New Albany,
IND 47150
1939 Goldsmith Lane, Louisville,
KY 40218
Phone: 502-451-9818
2118 Inwood Dr. #102,
Executive Office Park, Fort Wayne,
IND 46805
Phone: 219-484-1432

Shonin, Inc.
1485 Bayshore Blvd.,
San Francisco, CA 94124
Phone: 415-467-8700

Reed Electronic Marketing
P.O. Box 964, Del Mar, CA 92014
Phone: 714-452-1456
TWX: 910-322-1131
P.O. Box 206, Los Alamitos,
CA 90720
Phone: 213-598-6676
TWX: 910-341-7295

**Electronic Components
International**
450 Denison St., Markham,
Ontario L3R 1B9, Canada
Phone: 416-495-6202
Telex: 065-24011



Consumer electronics

Japan's watch market calm

Decision of semiconductor makers not to follow example of U. S. firms and integrate vertically has left business to timepiece firms

by Gerald M. Walker, Consumer Electronics Editor

Fads sweep through the closely knit Japanese society so fast that California looks stodgy in contrast. Especially volatile are new electronic products—radios, tape recorders, hi-fi systems, calculators, and the like—aimed at eager-to-buy Japanese youth. Why, then, did not the digital electronic watch erupt on the Japanese market to cause the chaos that disrupted the watch business in the United States?

For one thing, the Japanese never did take a fancy to the light-emitting-diode watch that established digital timepieces. More importantly, there was no overnight eruption of companies entering the digital watch market—with one major exception. Also, the Japanese semiconductor companies were slow to develop watch chips and have since been content to supply parts or modules to the watch companies that dominate the market, and no electronic watch

companies emerged to challenge the established producers. In addition, imports of the U. S. LED models made little inroad.

The single new firm is Casio Computer Co., a vertically integrated calculator producer. It has made a niche for itself in the domestic competition. With only Casio encroaching, the traditional houses, Seiko Time Corp., Citizen Watch Co., Ricoh Watch Co., and Orient Watch Co., have remained the Big Four in watches.

No shakeout. Consequently, prices have remained relatively stable, with the low end at about \$50; there has been no significant shakeout since there was hardly anybody to shake out; and producers are now looking forward to steady growth. The situation is dull compared with the U. S. digital watch market, but the Japanese producers like it that way. According to a survey of manufacturers conducted by *Electronics*, electronic watch sales in Japan should increase 25% next year to almost \$350 million. This year, the watch companies expect to log an increase of almost a third over the past year.

The bulk of 1977 sales was for analog, quartz-crystal timepieces. They outsold digitals by 4:1 or 5:1, according to Seiko. Digitals are coming on, however, and should close the gap to a 3:1 ratio next year.

Casio, which markets only digital models, says the margin is much narrower. It estimates that 46% to 47% of total Japanese production of

electronic watches this year has been digital, though a good proportion of this number was for export. In 1978, Citizen estimates, total domestic consumption will be about 10 million Japanese-made watches and 5 million imports. Of the 10 million units, about 2 million will be digital display models, according to Citizen.

Why is Casio successful? It had an established distribution network for its consumer calculators, but instead chose to challenge the established watch firms by doing things the traditional way, points out Ken Kashio, executive managing director. "We advertised and promoted our way into the watch business, but we stayed inside the domestic system through jewelers. After three years of struggle, we are trusted by the industry and accepted by the jewelers," he observes.

Another factor that has helped Casio is that it is the price leader domestically. With its own semiconductor capability, including a start in liquid-crystal displays for calculators, the company was able to enter watch production somewhat advanced on the learning curve.

With a stable domestic market and the established watch companies plus Casio in charge, there is not much inclination to rock the boat technically. Therefore, the producers are in no hurry to abandon the liquid-crystal display, although it is understood that an electrochromic-display watch may be introduced next year. There is not much chance that the Japanese will make tritium-back-light watches for domestic consumption because of the severe radiation limitations imposed by the government. □

Secure. Seiko, maker of this LCD watch, and others of the Big Four have had no competition from semiconductor makers.



INTRODUCING THE BENDIX PORTABLE MODULE TESTER



Now automatic, on-the-spot module testing is on the way.

Here's a new way to test anything from a printed circuit board to a complex logic system. And you can do it on the job.

Our new portable unit weighs just 30 pounds and has no moving parts. Yet it does everything that stationary digital cabinet-type units can. It eliminates downtime while modules are tested away from the job site. Does away with trial-and-error testing and unwarranted returns, too.

You can take it on board planes or ships, to hospitals, to labs, to computers or communications equipment, and to sophisticated quality-

control operations in mass production plants.

Highly trained operators are not needed. Programming procedures are so easy to pick up. And an interactive display system makes operation easier still. Test systems are stored on solid-state cards, providing reusable data memory.

The Basic Bendix unit is capable of testing cards to 64 pins and has the capacity to expand to 256. Additional options are available including:

- Fault Isolation Testing
- Digital Voltmeter/Frequency Counter
- Teletype Interface and Advanced Software Aids.

For more information, contact: Bendix Corporation, Test Systems Division, Teterboro, N.J. 07608. Or call (201) 288-2000, extension 1789.



Circle 79 on reader service card

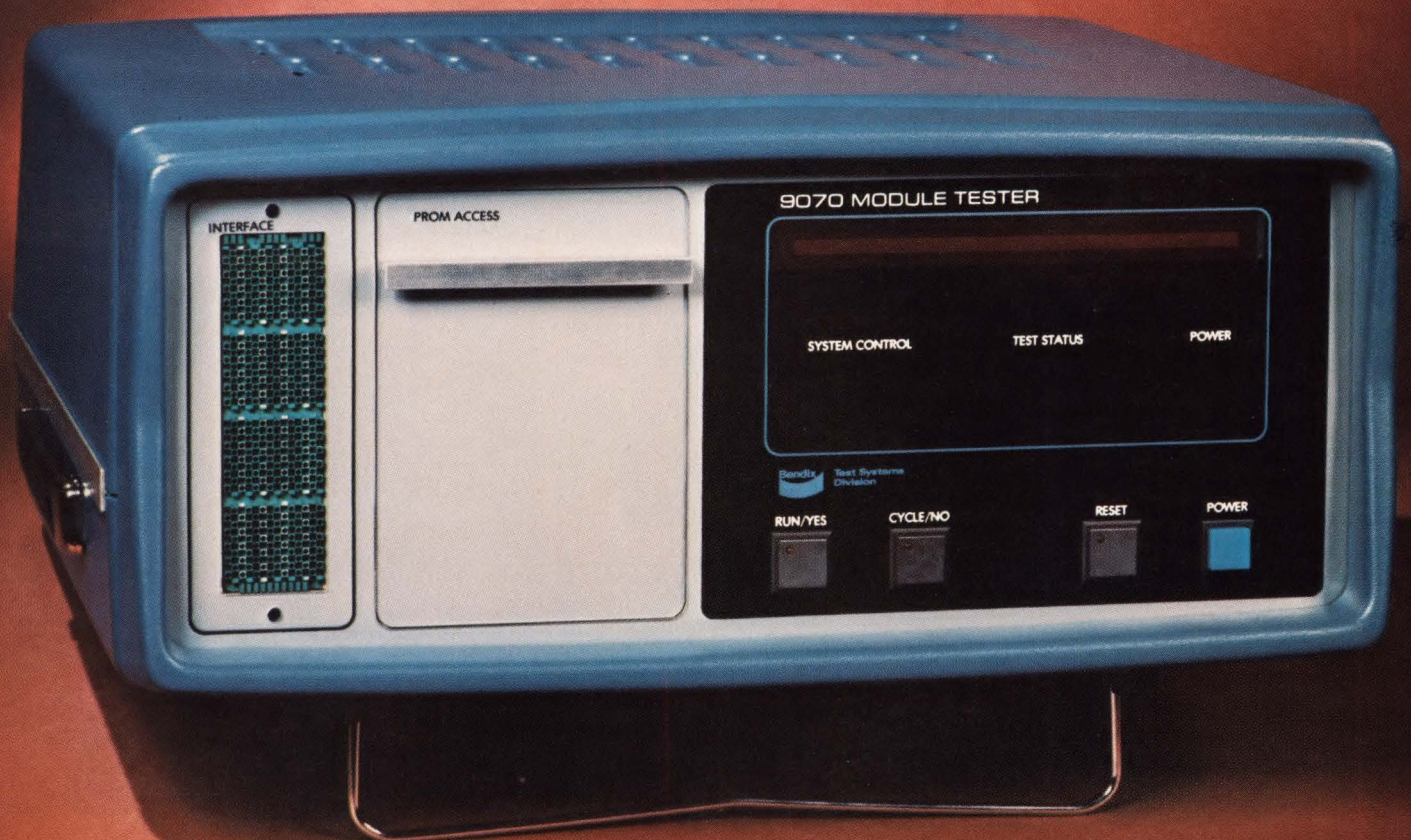

**TERADYNE
LASER
TRIMMERS.**

**A CUT ABOVE
THE REST.**

If you make film resistors or hybrids, make Teradyne your source for laser trimmers. There are four good reasons why.

EXPERIENCE

In the past six years Teradyne has established a base of over 200 laser trimming systems. An investment of over \$25,000,000 by the hybrid industry.

That's a lot of experience. Experience you'll see reflected in the systems we build and the services we provide.

TECHNOLOGY

The series of technological advances that made Teradyne number one are a direct result of your increased requirements. The galvanometer beam positioner. The high-speed bridge. The step-and-repeat handler. Multiplexed trim and test stations. Combined, they give you the highest-throughput trimmers in the business.

COMMITMENT

In order to stay number one, we've tripled the size of our laser trimming development staff in just the past year. This makes it the strongest team in the industry.

A new, higher-speed beam positioner is the first advance made by this expanded group. It won't be the last.

SUPPORT

Teradyne also offers you the most comprehensive after-sale support. Applications and service engineers in the U.S., Europe, and Japan are working to make your laser trimmers the most profitable in the world.

We provide regular software updates, too. Like our menu programming format. Its approach to the programming problem helps you get new parts into production fast.

In addition, we offer the industry's only 10-year circuit module warranty, worldwide parts stocking centers, and a 24-hour telephone troubleshooting service.

The fact is, no company has as many laser trimming resources as Teradyne. Nor can any company give you faster, more substantive support.

Before you invest in something as important as a laser trimmer, investigate the advantages of Teradyne.

For a more detailed account of what makes us a cut above the rest, write Teradyne, 183 Essex Street, Boston, Massachusetts, 02111.

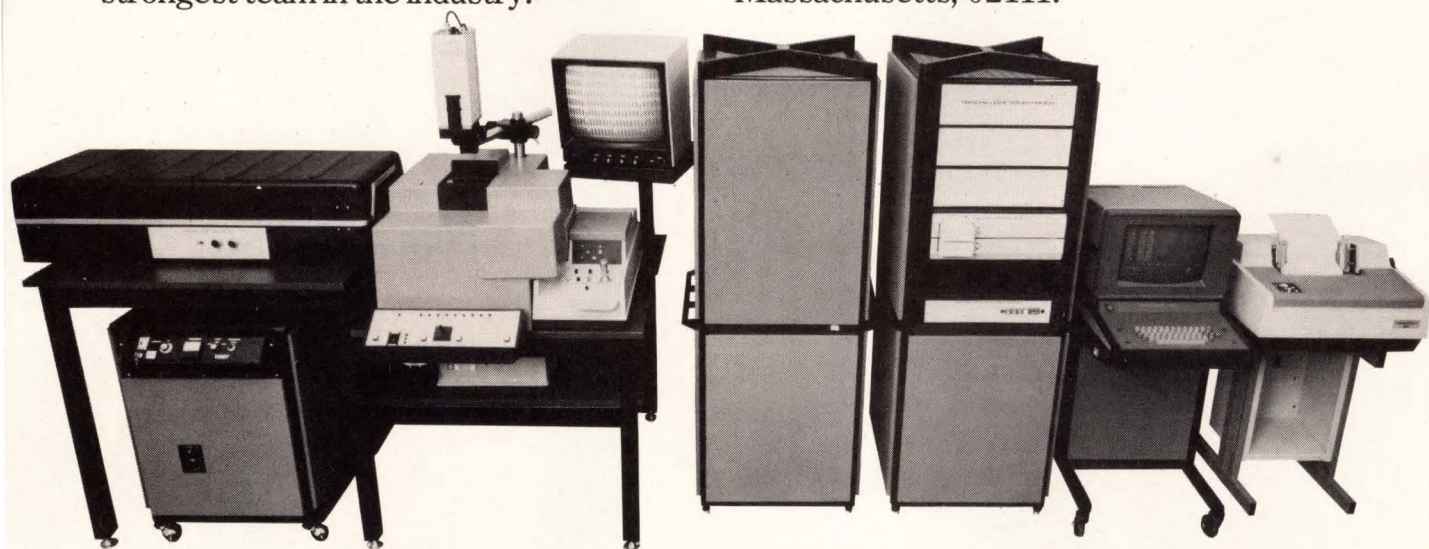

TERADYNE

Rockwell introduces the R6500.

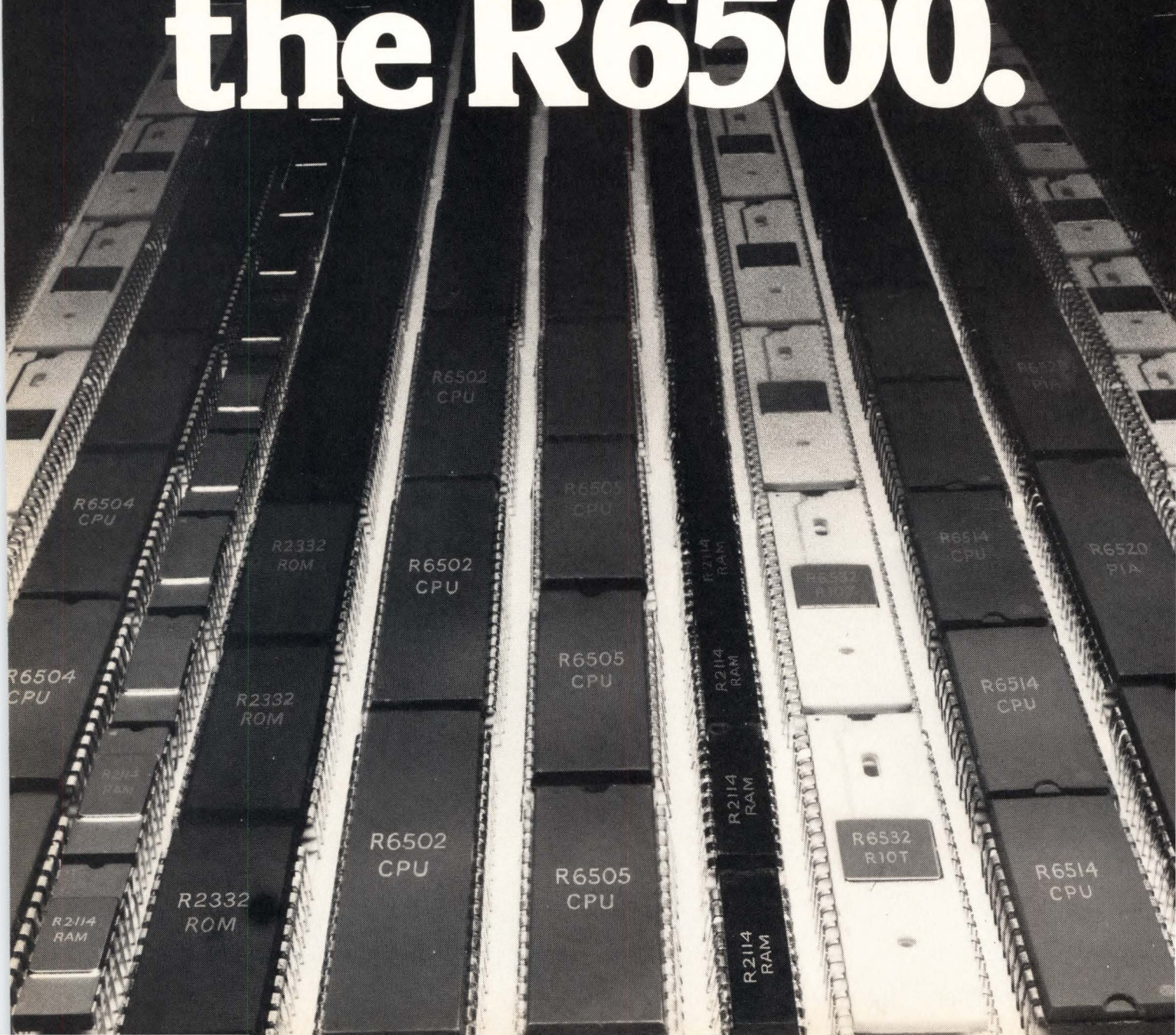

R 6500: the third generation microprocessor system

Now you can move up to the proven 2 MHz performance of an NMOS 8-bit microprocessor, the R 6500 from Rockwell.

Third-generation R 6500 architecture and instructions with 13 powerful addressing modes make it easier for you to design more functions in, more cost out. And the R 6500 is design-compatible with systems you may now be using.

R 6500 economics are on your side

Smaller R 6500 chips and single 5V power supply keep costs down as performance goes up. To get the right fit, choose from 10 software-compatible CPUs, eight versatile I/Os, ROMs, RAMs, and memory-I/O-timer circuits.

R 6500 CPU Options

	40-Pin DIP		28-Pin DIP					
	R 6502	R 6512	R 6503 R 6513	R 6504 R 6514	R 6505 R 6515	R 6506	R 6507	
Memory Address Space	65K	65K	4K	8K	4K	4K	8K	
Interrupts — Maskable	Yes	Yes	Yes	Yes	Yes	Yes	Yes	
— Non-Maskable	Yes	Yes	Yes	No	No	No	No	
SYNC — Output indicates op code fetch cycle	Yes	Yes	No	No	No	No	No	
RDY — Single step and slow memory synchronization	Yes	Yes	No	No	Yes	No	Yes	
Φ_1 Clock Output	Yes	Yes	No	No	No	Yes	No	
DBE — Extended Data Bus Hold Time	No	Yes	No	No	No	No	No	

I/O Devices

PART #	NOMENCLATURE	DESCRIPTION
R 6520	Peripheral Interface Adapter	2, 8-bit bidirectional I/O ports; 4 peripheral control/interrupt lines.
R 6522	Versatile Interface Adapter	PIA functions plus 2, 16-bit programmable interval timers/counters.
R 6530	ROM-RAM-I/O-Timer	1024 x 8 ROM, 64 x 8 static RAM; 2, 8-bit bidirectional data I/O ports; 2 programmable data direction registers; 8-bit interval timer.
R 6532	RAM-I/O-Timer	128 x 8 RAM; 2, 8-bit bidirectional data ports; 2 programmable data direction registers; 8-bit interval timer.

PLUS ROMS, RAMS...AND MORE ON THE WAY

Rockwell adds solid development support

For fast and efficient system design, Rockwell offers SYSTEM 65 — one of the smartest and lowest-cost, disk-operating, complete development systems available. It's equipped with two mini-floppies, resident two-pass assembler, text editor and monitor/debug package.

KIM-1, TIM, timeshare, complete documentation, plus extensive applications engineering are also available.



Rockwell is delivering in volume now

R 6500 circuits are already being produced in quantity with Rockwell's N-channel, silicon-gate, depletion load process.

R 6500 devices and SYSTEM 65 development microcomputers are now available at your local Hamilton-Avnet or Schweber distributor.

And new chips are in design. The first, a fully static 32K ROM, is now in production.

For your R 6500 brochure write: D-727-F, Marketing Services, Microelectronic Devices, Rockwell International, P.O. Box 3669, Anaheim, CA 92803, U.S.A. or phone (714) 632-3729.



Rockwell International

...where science gets down to business

NEC Newscope

Tiny Random Access Memory Faster And Uses Less Power

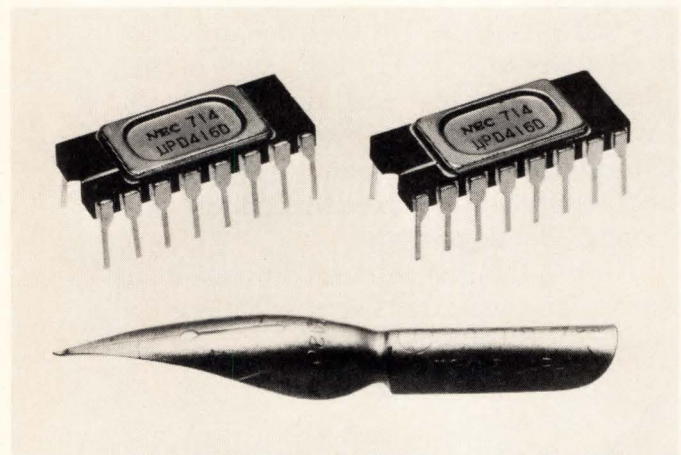

Small size of the new NEC RAMs is seen in this comparison with a pen nib.

NEC successfully developed a 16K bit RAM series and has already put it on the market both at home and abroad.

The new product named the "μPD416 Series" is available in four types depending on access time and cycle time ranging from 150 to 300 nano-seconds and 375 to 650 nano-seconds, respectively.

The μPD416 has two most significant features. The improved memory, which uses a very-small-signal circuit and a high sensitivity amplifier in each block, has made it possible to increase the speed as well as to minimize power consumption. The mounting density is remarkably increased by the use of double-layer wiring. The size of a chip is 3.6 x 6.3 mm.

NEC expects to produce about 100,000 chips during the second half of 1977 for computers, minicomputers, microcomputers, peripheral machines and broadcast equipment.

NEC Shows Record Gain In Fiscal 77

During the fiscal year which ended March 31, 1977, NEC's earnings and sales continued to show strong improvement despite a weakening in the overall economy during the year.

Consolidated net income after taxes for fiscal 1977 was ¥7.74 billion (\$28.1 million)*, an increase of over 4.5 times as compared with ¥1.70 billion (\$6.2 million). On the other hand, consolidated sales and other income marked a 19 percent increase, amounting to an all-time high of ¥642.48 billion (\$2.34 billion), compared to ¥542.22 billion (\$1.97 billion) recorded in the previous year.

The record gain was attributed mainly to intensified marketing efforts conducted on a variety of new and existing products. Sales in all four categories were up over the previous year, with telecommunications equipment registering a six percent increase, electronic data processing and industrial electronic systems an 11 percent increase, electron devices a 45 percent increase and consumer electronics a 30 percent increase.

*Exchange rate \$1 equals ¥275.

NEC Transportable ESS Key Aid In U.S. Re-equipment Projects

The NEC-built fully-stored program controlled space division ND-20B electronic switching system (ESS) was officially cut over earlier this year at the New Canaan office of the Southern New England Telephone Co. (SNET) in New Canaan, Connecticut, U.S.A.

The ND-20B, equipped with 10,000 lines contained in three 40-foot-long modules, is capable of fully meeting the various requirements of tomorrow's telecommunications network for diversified communications.

The transportable ND-20B ESS will be utilized until the existing step-by-step equipment can be cleared from the central office building and new equipment installed. This arrangement, conceived by SNET and NEC, will save construction costs and provide modern service for New Canaan during the installation of the permanent equipment. When the permanent installation is complete, the ND-20B will be relocated at another project in Darien, Connecticut. The initial project was only five months in installation and future installations are expected to take even less time.

The ND-20B is one of NEC's ND-Series systems constructed on the basis of Nippon Telegraph and Telephone Public Corporation's standard D-10 and -20 systems, the only modifications being with respect to signaling and charging to meet overseas markets.

There are three ND-Series systems. The 10B can accommodate up to 65,000 lines while the 20B is of medium capacity with 32,000 lines. The ND-20S gives a line capacity of from 500 to 6,000. In addition, the ND-20B and the ND-20S can be converted into van-type systems.

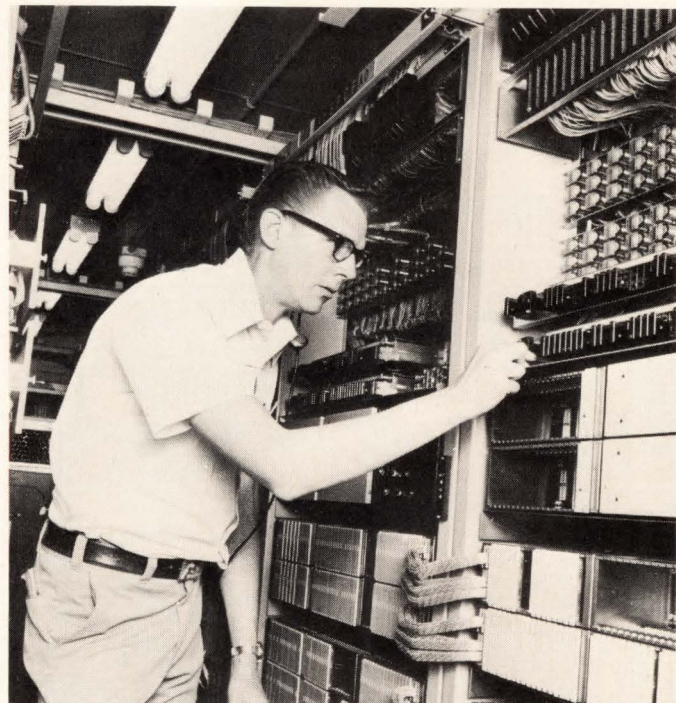

Southern New England Telephone Co. (SNET) technician Mr. John Furness checks ND-20B ESS installed by NEC at SNET's central office in New Canaan, Connecticut, U.S.A.

New Submarine Cable Links Japan, Philippines, Hong Kong

The OLUHO cable system linking Okinawa (Japan), Luzon (Philippines) and Hong Kong was recently completed as an international project jointly by Eastern Telecommunication Philippines Incorporated of the Philippines, Cable & Wireless Ltd. of England and Kokusai Denshin Denwa Co., Ltd. (KDD) of Japan.

NEC, as the prime contractor for the Okinawa-Luzon route, manufactured and supplied the necessary equipment. NEC engineers also cooperated with KDD in the installation of the equipment and cable aboard the "KDD Maru," a cable laying ship owned by KDD.

The Okinawa-Luzon route has a CS-12M submarine cable system using a total of 1,340 kilometers of coaxial cable with a diameter of 38.1 mm, 115 transistorized submarine cable repeaters and 7 ocean block equalizers. The system handles 1,600 telephone circuits on the 3 kHz band.

The CS-12M system is a newly-developed coaxial submarine cable system, featuring especially high reliability. Its mean time between failures is more than 20 years, ensuring stable and reliable operation for more than 20 years without maintenance.

In addition to the submarine cable repeaters and other under-sea equipment, NEC has also manufactured and installed all the necessary terminal equipment at the cable landing stations both in Okinawa and Currimao in northwest Luzon for the Okinawa-Luzon route.



The OLUHO cable system is a very important link in regional and world communications.

NTC Award Goes To Six NEC Engineers

Six NEC engineers won the highest award for the paper they presented at the National Telecommunications Conference (NTC).

The "76 NTC Best Paper Award" was officially presented to the six NEC engineers at the International Communication Conference (ICC) held earlier this year in Chicago, Ill.

The paper was on a new NEC-developed system, called the NETEC-22H, which transmits NTSC color television signals in digitalized form. Based on an interframe coding technique, it yields significantly high data compression ratio of 1/2 to 1/3 of the conventional transmission rate for relaying color television programs by satellite or terrestrial microwave transmission. The paper was selected from more than 200 papers presented at the 1976 NTC.

The six engineers were Mr. Tatsuo Ishiguro, Dr. Kazumoto Inuma, Mr. Yukihiko Iijima and Mr. Toshio Koga of the Central Research Laboratories, and Mr. Shintaro Azami and Mr. Takayoshi Mune of Transmission Equipment Division.

Christmas Island RARR System Vital To Orbit ETS-II Satellite

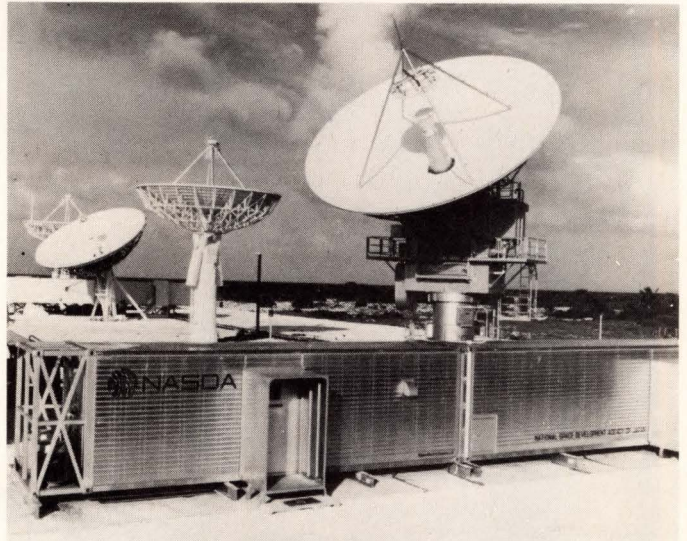

The NEC-built RARR tracking antenna on Christmas Island.

A newly-completed NEC range and range rate system on Christmas Island for the National Space Development Agency (NASDA), Japan, played a vital role in placing the second Japanese engineering test satellite (ETS-II) into a stationary orbit.

The experiment is being carried out by NASDA, the satellite having been sent aloft from its Tanegashima Space Center on Tanegashima Island between Kyushu and Okinawa.

The new range and range rate (RARR) system installed at NASDA's downrange tracking station on Christmas Island, which is in Polynesia in the central Pacific, was equipped by NEC in time for the experiment. The RARR system measures the range and range rate of a satellite, yielding data used to work out the flight course.

The main purposes of the launching of the ETS-II are to acquire skills for placing a satellite into stationary orbit and for measuring the range and range rate as well as for keeping the satellite in its orbit, to test and acquire satellite house-keeping, to conduct an antenna deployment experiment and to carry out propagation tests with millimeter and quasi-millimeter waves.

In addition to the downrange tracking station on Christmas Island, NEC has equipped other tracking stations around the country.

The NEC-built ground support equipment for the experiment includes the range control system, destruct command transmitters, various types of ground test equipment, a rocket telemetry receiver, a telemetry receiver, guidance radar, tracking radar, and many other units.

NEC
Nippon Electric Co., Ltd.
P.O. Box 1, Takanawa, Tokyo, Japan

Help yourself, **oem!**

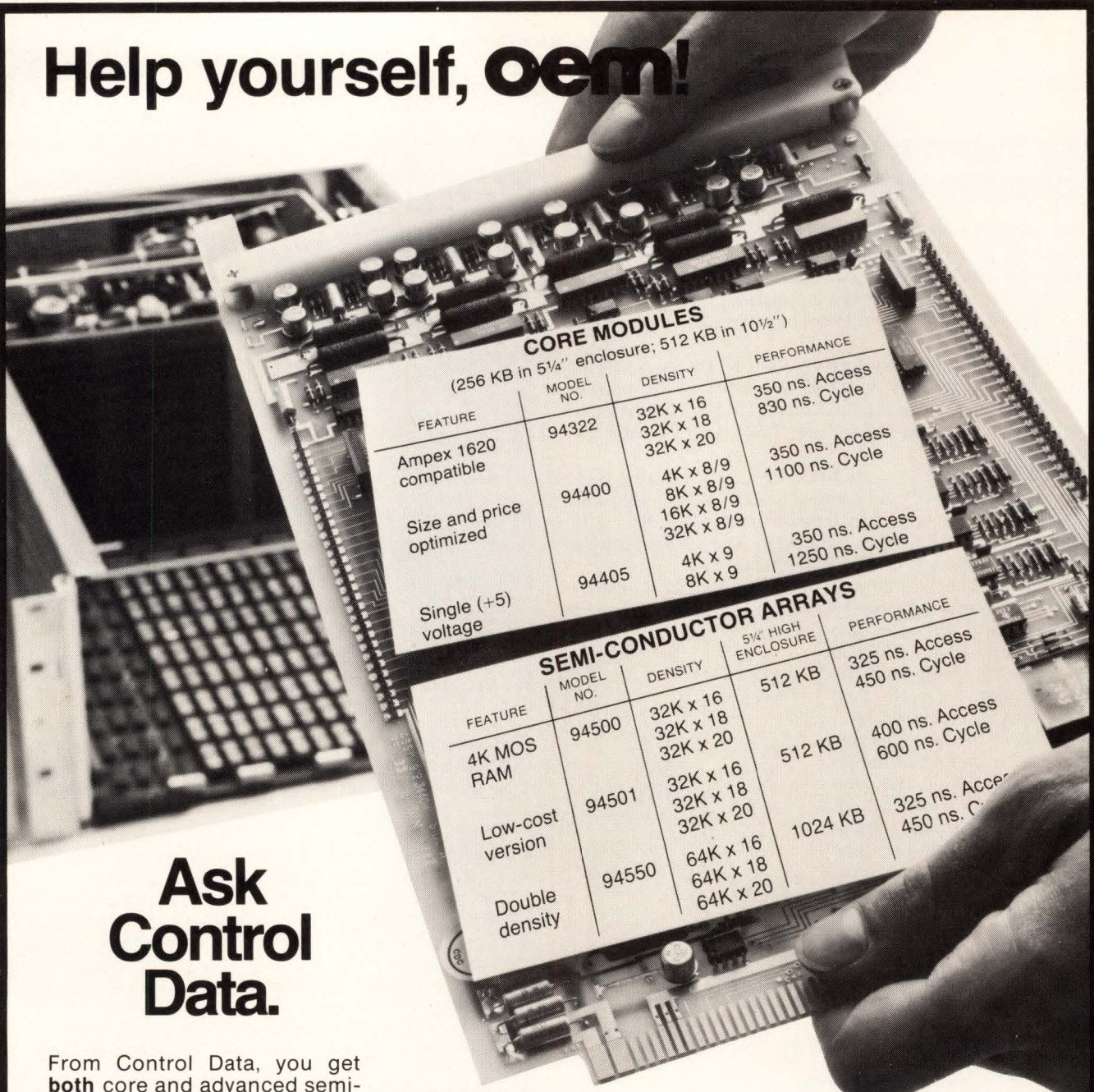

CORE MODULES
(256 KB in 5 1/4" enclosure; 512 KB in 10 1/2")

FEATURE	MODEL NO.	DENSITY	PERFORMANCE
Ampex 1620 compatible	94322	32K x 16 32K x 18 32K x 20	350 ns. Access 830 ns. Cycle
Size and price optimized	94400	4K x 8/9 8K x 8/9 16K x 8/9 32K x 8/9	350 ns. Access 1100 ns. Cycle
Single (+5) voltage	94405	4K x 9 8K x 9	350 ns. Access 1250 ns. Cycle

SEMI-CONDUCTOR ARRAYS

FEATURE	MODEL NO.	DENSITY	5 1/4" HIGH ENCLOSURE	PERFORMANCE
4K MOS RAM	94500	32K x 16 32K x 18 32K x 20	512 KB	325 ns. Access 450 ns. Cycle
Low-cost version	94501	32K x 16 32K x 18 32K x 20	512 KB	400 ns. Access 600 ns. Cycle
Double density	94550	64K x 16 64K x 18 64K x 20	1024 KB	325 ns. Access 450 ns. Cycle

Ask Control Data.

From Control Data, you get **both** core and advanced semi-conductor memory. You get "state of the art" in high density packaging techniques. (Example: the 94550 semi-conductor memory provides 1 megabyte in the 5 1/4" rack shown above!) You get **competitive pricing**, in custom or off-the-shelf standard configurations!

Also available:
UNITEMP core. In 13-mil and 18-mil sizes. UNITEMP is the temperature-independent magnetic ferrite core stable over the entire MT temperature range (0°-90° C).
Enclosures. For mounting core or semiconductor modules in standard EIA 19" racks.

Cabinets measure 5 1/4" or 10 1/2" high, 20" deep; cards mount horizontally. Self-contained cooling fans direct air horizontally across the modules. Both core and semi-conductor modules can be incorporated to a maximum of 1 megabyte.

Phone (612) 830-6018 or write: Richard J. Koebler, OEM Marketing Manager, Computer Memory Manufacturing Division, 8001 East Bloomington Freeway, Bloomington, Minnesota 55420. Please tell me more about your OEM Memories!

Ask our **oem** people

NAME _____ TITLE _____
 COMPANY _____ ADDRESS _____
 CITY _____ STATE _____ ZIP _____ PHONE _____

GD CONTROL DATA CORPORATION

A software development breakthrough.



FORTTRAN compiler and relocatable macro assembler in a new custom software system for micros.

Now it's easier than ever to create smooth running custom software for PCS SuperPac 8080 A-*based microcomputers. And it takes less time, too. With SPDS. The SuperPac development system.

SPDS has resident software you'd expect to find only in minis. Like a FORTRAN compiler option for fast, easy programming in a language your programmers already know (look for BASIC soon). A cross-reference generator that lists constants, labels and addresses and really saves time when you're moving segments around. A relocatable assembler with full macro capability. And an up-down loader for directly loading software into a target system up to 1,000 feet away and calling it back to the development system

whenever you need it.

Choose the hardware tools you need. A desk console and dual floppy are standard. From there it's up to you. EPROM programmer, CRT terminal, choice of two line printers and paper tape reader are optional.

SPDS for SuperPac microcomputers. It's a software development breakthrough. From Process Computer Systems, of course. The full service microcomputer manufacturer.

* And, soon, for our new Z-80 based micros.

Tell me more. ■ SPDS ■ SuperPac ■ Please have salesman call.

Attach your business card here.

pcs

Success is PCS.

Process Computer Systems, Inc.
750 North Maple Road, Saline, Michigan 48176
313-429-4971 TWX 810-223-8153
Circle 87 on reader service card

Here's what you get in our new Model 802 pulse generator: four simultaneous outputs over the frequency range of 5 Hz to 50 MHz — fixed level sync, TTL and TTL, plus a variable 5-volt output. The upper and lower pulse levels are independently adjustable, and so are width and delay. For operational modes, the 802 gives you continuous, triggered, gated, and double

pulse. You won't find features like these anywhere else for under \$600. Now if you need even more versatility, we've got that, too. The Model 801 (top left) does everything the 802 does, and more — including adjustable rise/fall from less than 7 nsec. It goes for \$995. Our Model 145 (bottom left) is a full-fledged pulse generator and a function generator

as well for just \$895.

So if you're looking for high performance, low price, and top quality in pulse generators, the only name you need to remember is ours. WAVETEK, 9045 Balboa Ave., P.O. Box 651, San Diego, CA 92112, Phone (714) 279-2200, TWX 910-335-2007. U.S. prices only.

WAVETEK®

**At \$595,
our newest pulse generator
is no bargain.**



It's a steal.

Microcomputer families expand, part 1: the new chips

by Laurence Altman, *Solid State Editor*



□ If microcomputer performance and density are almost doubling each year, microcomputer designs are multiplying very much faster. In place of the few easily classified families that existed 18 months ago, the system designer now confronts a dazzling array of microcomputer chips, many of which overlap each other in performance, design flexibility, and ease of implementation. The microcomputers that dominated the mid-1970s, such as the 8080 and 6800, are rapidly evolving into powerful general-purpose microcomputer systems, in the middle as well as at either end of the performance spectrum.

At first glance the most experienced eye could easily be confused by the myriad of new possibilities. But a closer look reveals four major system design categories (see Table 1).

At the lowest end are the customized, dedicated logic designs—the 4-bit chips that sell for less than \$3. They are the stand-alone control units used mostly in such consumer products as non-video games, microwave ovens, television tuners, fancy watch-calculator combinations, and the like. Like the calculator chips from which they have been adapted, the 4-bit devices are not intended to manage external memory or handle input/output controls. They work alone or with high-current drivers for operating lamps, valves, and sole-

noids. Very low in cost, they are aimed at designs needing 10,000 pieces or more. Most popular of the 4-bit units are Rockwell Microelectronic Group's PPS 4/1 family, Texas Instruments Inc.'s TMS 1000 family, National Semiconductor Corp.'s COPS family, and General Instrument Corp.'s 1644 microcontrollers.

Next up the scale are the general-purpose logic designs for industrial and peripheral control, instrumentation equipment, video games, and automotive applications. This is the meat of the powerful new byte-oriented microcontrollers, such as Intel Corp.'s 8048 family, Mostek Corp. and Fairchild Semiconductor's one-chip F8s, TI's 9940, and General Instrument's 1650. Like the 4-bit types, these 8-bit units are self-contained microprocessors—central processing unit, read-only memory, random-access memory, and input/output controls all on one chip. But unlike the 4-bit chips they are powerful computational units in their own right. Because of this, users are turning to them for many of the jobs once handled by the more expensive multichip families.

Moreover, both I/O control and program ROM and data RAM on some of the 8-bit chips are expandable with matched memory-I/O combination chips, making it easy for users to add performance or features to their designs. Most important, this 8-bit type is software-compatible

TABLE 1: RANGE OF TODAY'S MICROCOMPUTER DESIGNS

		Control		Data Processing	
		Dedicated 4-bit	General-purpose 8-16-bit	Distributed 8-bit	Central 16-bit
		single chip, high volume (10,000-piece lots), very low cost (\$3)	single chip, medium volume, low cost	multi-chip, low volume, medium cost	multi-chip, very low volume, high cost
Application		Consumer-oriented: TV tuner, non-video games, appliances, entertainment	Industrial: instrumentation, automotive, peripheral controller, machine controller	Business and real-time control: intelligent terminals, industrial control, process control	Real-time data processing: data base, data processing, big business, scientific
Capacity		Limited chip capability: 4-bit data manipulation, small-program ROM, small on-chip RAM, limited I/O, not expandable	Fairly extensive chip capacity: 8- or 16-bit data handling, 2 kilobytes program ROM, 128 bytes of RAM, extensive I/O, expandable	Extensive chip capacity: 8- or 16-bit data handling, 64 kilobytes of ROM, 64 kilobytes of RAM, extensive I/O, unlimited expansion	Very extensive chip: capacity 16-32-bit data handling 65 kilobytes of ROM 256 kilobytes of RAM unlimited expansion

Source: Electronics

with multichip families, so that on outgrowing a one-chip solution, the user may immediately move up to the powerful multichip sets without incurring much additional software expense.

In the mid-performance range there are the distributed data-processing and real-time peripheral control jobs, and this is where the multichip 8- and 16-bit microcomputer families are now finding most use. The applications often require real-time arithmetic processing, 32 and 64 kilobytes of data storage, and program repertoires that use up 16 and 32 kilobytes of ROM, all far beyond the range of the most powerful one-chip designs. These are the upgraded 8080/8085, 6800, Z-80, 9900, 6500, 1802, IN1600, and 2650 families.

Power at the periphery

It is within the ambit of these general-purpose multichip families that the new peripheral chips are being developed. Serving software-programmable control functions, they are display and keyboard controllers, direct-memory-access controllers, data-communications interface controllers, printer controllers, and the like. Extremely powerful chip implementations that often require twice and three times as much circuitry on the chip as the CPUs themselves, they offer a new level of system integration, often replacing tens or hundreds of transistor-transistor-logic packages.

All the major suppliers of multichip families are introducing these peripherals. In the lead are Intel, Zilog, Motorola, TI, National, AMD, Fairchild, Mostek, and Signetics. Also involved are specialty integrated-circuit manufacturers such as Standard Microsystems Corp., Western Digital Corp., Matrox Corp., and others, which have no plans to supply CPUs.

To control these complex peripheral chips, microcomputer manufacturers are offering enhanced CPU chips for greater performance with fewer parts. Typical of these families are the 8085, which will soon be offered by Intel Corp. in a 5-megahertz version, and the Z-80, which is

being supplied in the standard 4-MHz version. The 6800 and 6500 families have 2-, 3-, and 4-MHz options as well. These extensions of the standard mid-range designs now allow a system designer to build a powerful real-time controller in just a dozen chips, when before he needed two or three dozen.

Finally, at the highest end of the microcomputer performance spectrum, there are the centralized data-processing systems that require either an integrated 16-bit processor family, such as the TMS 9900, or a bit-slice design implemented with low-power Schottky TTL or integrated injection logic. Clearly, the bit-slice approach, with its set of multiple-length instructions, pipelined architecture, and microprogrammable software capability, is reserved for the full-fledged minicomputer applications, where a designer must accommodate multi-level interrupts and access to an external data memory in excess of 65 kilobytes. Second- and third-generation bit-slice designs are just becoming available, offering system throughput above 20 MHz, well into the high end of minicomputer capability.

Bit-slice options

The most popular of the bit-slice designs is Advanced Micro Devices' 2900 family, which will also be supplied by Raytheon, National, Motorola, Fairchild, Signetics and others. An alternative to the 2900 is TI's recently introduced S481 family, a functionally equivalent 4-bit slice. There is also the 10800 ECL family from Motorola and Fairchild's Macrologic computer chip family.

Meanwhile, new, more powerful, 16-bit microprocessors are on the design table for these central data-processing applications. Intel, for example, is preparing its 8086 CPU design for entry in the middle of next year, at about the same time Zilog will make available its Z-8000 16-bit unit and Motorola its 16-bit 6809. All promise more efficient data manipulation, since they will use 16-bit-wide words and attain system throughputs reaching to 20 MHz. The three new designs will be

wholly compatible with their respective 8-bit families.

These devices will offer in minimum chip configurations the same processing capability as present high-performance minicomputer machines. With them, original-equipment manufacturers will be able to use centralized high-level processing in a wide range of real-time and data-processing applications at a fraction of the cost of stand-alone minicomputer boxes.

Tying all this hardware together are new, more efficient development systems and high-level software packages that make microcomputer design quicker, cheaper, and more effective than ever before. Moreover, microcomputer manufacturers, notably Intel, Zilog, Motorola, and National, as well as minicomputer manufacturers like Digital Equipment Corp. and Data General Corp., are offering a wide range of microcomputers-on-a-board that essentially do all the system design and machine software development and testing their customers need, besides eliminating a good deal of their buyers' manufacturing and assembling costs. These microcomputer boards will be the subject of Part 2 of this article, which will appear in the next issue of *Electronics*.



Designers of general-purpose equipment of the type found in a wide assortment of peripheral controllers and intelligent terminals will want to evaluate the new 8-bit microcomputer chips that are now on the market and compare them with soon-to-be-available designs (Table 2). In many instances these one-chip microcomputers can be used in place of more costly multichip solutions, especially in systems that need no more than 2 kilobytes or less of program and 64 bytes or less of data memory.

All these one-chip processors contain all the elements of the microcomputer—arithmetic and control processing, program memory in the form of hardwired or reprogrammable read-only memories, scratch-pad data manipulation in small random-access memories, and a variety of input/output control logic. But here their similarities end.

The biggest differences between the three chips that are now available, the F8 or 3870, the 8048, and the 9940, are architectural. For example, the 3870 has a

register-oriented architecture, with 16 general-purpose and control registers residing within one 64-byte bank of on-chip data RAM. Since the memory makes no distinction between data-processing and control operations, this register operation will be quite complex, especially for the uninitiated user. Some registers overlap in the memory locations, the same spaces often being used for as many as three functions.

This architecture, however, allows the experienced designer to apply a substantial amount of software finesse for implementing complex systems with one chip. Indeed, the results can be quite rewarding, owing to the fact that these registers can be addressed either as data memory locations in RAM, as general-purpose control registers, or even as pairs from each for address control housekeeping. (Newer versions of the 3870 will contain another bank of 64 bytes of RAM, a hardware improvement that will increase its data-handling capability.) Moreover, the 2,048 words of program ROM make the chip one of the most powerful available today, with newer versions with 4,096 words on the way.

Besides the big ROM, one of the best features of the 3870 is the extensive set of operations that can be performed with the on-chip accumulator. These operations are done automatically, by means of a 6-bit RAM address register that can be auto-counted either up or down. The automatic count occurs only on the least significant 3 bits, which are enough to partition the RAM into eight segments for such operations. This extensive memory mapping gives the user very fast access to RAM storage, speeding up instruction execution and enlarging system capacity.

The 3870 also has a set of arithmetic and logic instructions that can be performed automatically from program memory in the accumulator. Since the accumulator can perform real-time operations, it can be used for interrupt-driven instruction routines. This is useful in applications in data communications, where priority reassignments are frequent. The only limitation here is the size of the fixed program memory since these priority instructions are limited to operations from fixed table locations in the ROM.

Differences of detail

The 8048, like the 3870, has a register-oriented architecture, but unlike the 3870 packs two banks of 8-bit registers into the 64-by-8-bit RAM. The selected bank can operate with the accumulator directly from easily constructed instructions. There is also a full set of increments and decrements available with any of the registers, adding considerably to flexibility in high-throughput sequencing operations.

As in the 3870, the 8048's RAM operations can be done with indirect register addressing, using either of two registers in the selected register bank. Therefore, the same operations that can be performed with these registers can also be performed with RAM locations, adding still further to the device's flexibility.

Another 8048 strength is superior bit manipulation. In addition to instructions for manipulating the flags and carry bits, the 8048 has instructions for directly testing the flags, the carry bit, the accumulator conditions, or

TABLE 2: SINGLE-CHIP 8- AND 16-BIT MICROCOMPUTERS

Manufacturer	Intel	Mostek	Fairchild	TI	Zilog	Motorola	Rockwell
Type	8048	3870	3859	9940	2-8	6801	6500
ROM size (bytes)	1,024	2,048	1,024	2,048	2,048	2,048	2,048
RAM size (bits)	64	64	64	128	144	128	64
Instructions	96	70	70	58	96	72	53
I/O bits	32	32	32	32	32	30	34
Power supply (V)	+5						
Availability	now				1st quarter, 1978		

Source: Electronics

any bit in the accumulator, as well as external test and interrupt conditions.

The biggest limitation of the 8048 is its modest program size—1,024 words of read-only memory. However, larger program capacity is obtainable with a matched 2,048-bit ROM-and-I/O chip that works directly with the 8048 mother chip. Moreover, the system's data memory can be expanded as well, by means of another matched chip that combines a 2-k RAM with I/O circuitry. Altogether, the set offers the user a three-chip implementation (Fig. 1) of a host of general-purpose control applications.

The 9940 differs radically in architecture from both the other chips, having a 16-bit architecture like that of TI's TMS 9900 multichip family. Of particular significance is its data memory: a 64-by-16-bit RAM divided into four working spaces. As in the 9900, these working spaces lend themselves to multiprocessor systems, where a portion of memory from each processor station is used for each task and the processor quickly changes tasks by automatically switching to a new temporary working space. Extremely fast switching of this kind is unique in one-chip designs and allows the 9940 to be used in conjunction with the 9900 CPU for performing multiprocessing and multilevel interrupt operations.

Each working space contains 16 words, a powerful vocabulary for a one-chip design. Moreover, only four of these words are needed to manipulate the on-chip control registers for handling status, program linking, and I/O reference addressing. This leaves 12 registers available in each working space for problem solutions. Finally, the 9940 16-bit instruction word capability gives the chip a more extensive instruction set than most 8-bit processors could accommodate.

Designing with one-chip types

How these one-chip microcomputers lower the costs of peripheral designs is shown in Fig. 2, where a TI model 745 electronic data terminal has been designed around an 8080A microprocessor system (Fig. 2a) and then redesigned around a 9940 (Fig. 2b). The 8080-based hardware requires 17 integrated circuits, 41 resistors, one crystal, and one capacitor. The 9940-based design needs only two ICs—a 9940 and a 9902 asynchronous communication control chip—plus 18 resistors, one crystal, one capacitor, and 16 diodes.

The comparison becomes even more dramatic when one considers that the 8080 design requires 2 kilobytes of external ROM (two TMS 4700s) and 64 bytes of external RAM (one TMS 4036), plus a complex 5501 8080A peripheral I/O control, which in itself contains a universal asynchronous receiver/transmitter, programmable timers, interrupt prioritization and control, an 8-bit input port, and an 8-bit output port. Moreover, the 8-bit output port of the 5501 must in turn be expanded with TTL components (7406, 74174, 74175 driver packages) to provide the necessary number of direct outputs for the printer's keyboard and the necessary latched outputs for the printer's character analyzer routines.

Contrast this with the 9940-based design. The internal memory of the 9940 provides the needed 2 kilobytes of ROM and 128 bytes of RAM. Moreover, the chip's 32 I/O

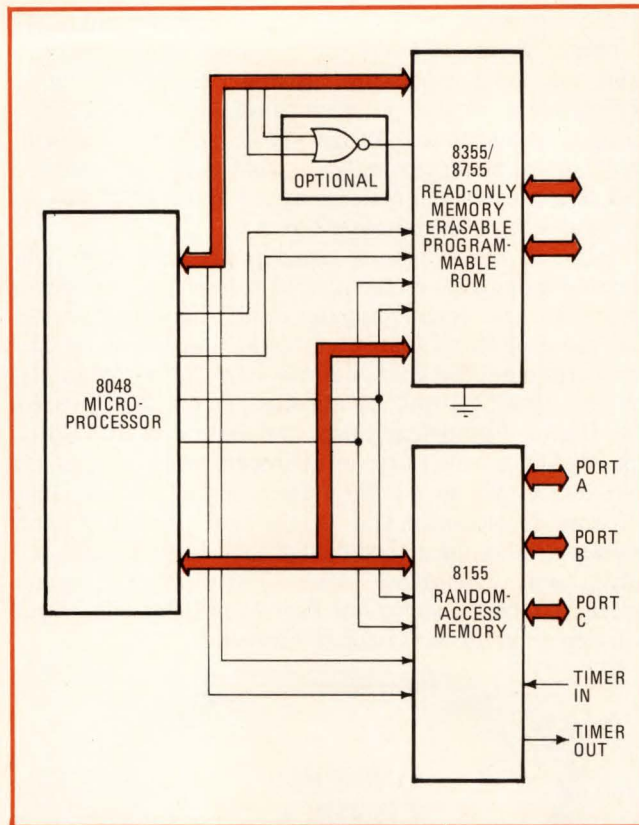

1. One times three. Intel's MCS-48 one-chip microcomputer can be expanded into a three-chip system with additional, related RAM and ROM chips. The complete system provides 3 kilowords of program memory, 320 words of data memory, and 53 I/O lines.

lines are enough to interface with all of the printer's mechanical functions. Meanwhile, the readily available 9902 peripheral controller is used to control and manipulate all print-head data. All in all, the 9940-based design reduces the cost of such terminals to a 10th of that of their multichip implementation.

Just as awesome a display of efficiency is provided by an 8048-based keyboard-display module. In fact, the 8048 can readily be used to implement a wide variety of remote data entry terminals, including keyboard-display units of 80 to 120 keys and displays of 16 seven-segment or dot-matrix digits. In all these configurations, the processor performs all keyboard functions: first-in, first-out data sequencing, debounce, N-key roll-over, character buffering, and various programmable modes for error indication, automatic repeat, and detection of both key depression and release.

The simplest 8048-based terminal configuration consists of an 80-key matrix of contact-type or Hall-effect keys and a display of 16 seven-segment digits. In this system the 8048 scans the keyboard, refreshes the display, and sends and receives data over a serial asynchronous channel. To minimize hardware, the sending and receiving of serial data is implemented in software. Here, data is transferred in standard teletypewriter serial ASCII format, consisting of a start bit, 8 data bits, and one or two stop bits.

Transmitting the serial code is straightforward. First the processor is programmed so that it will not send or

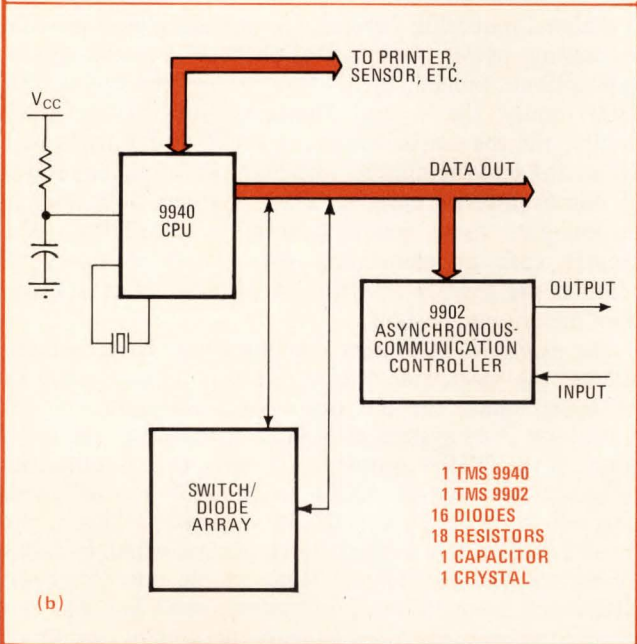
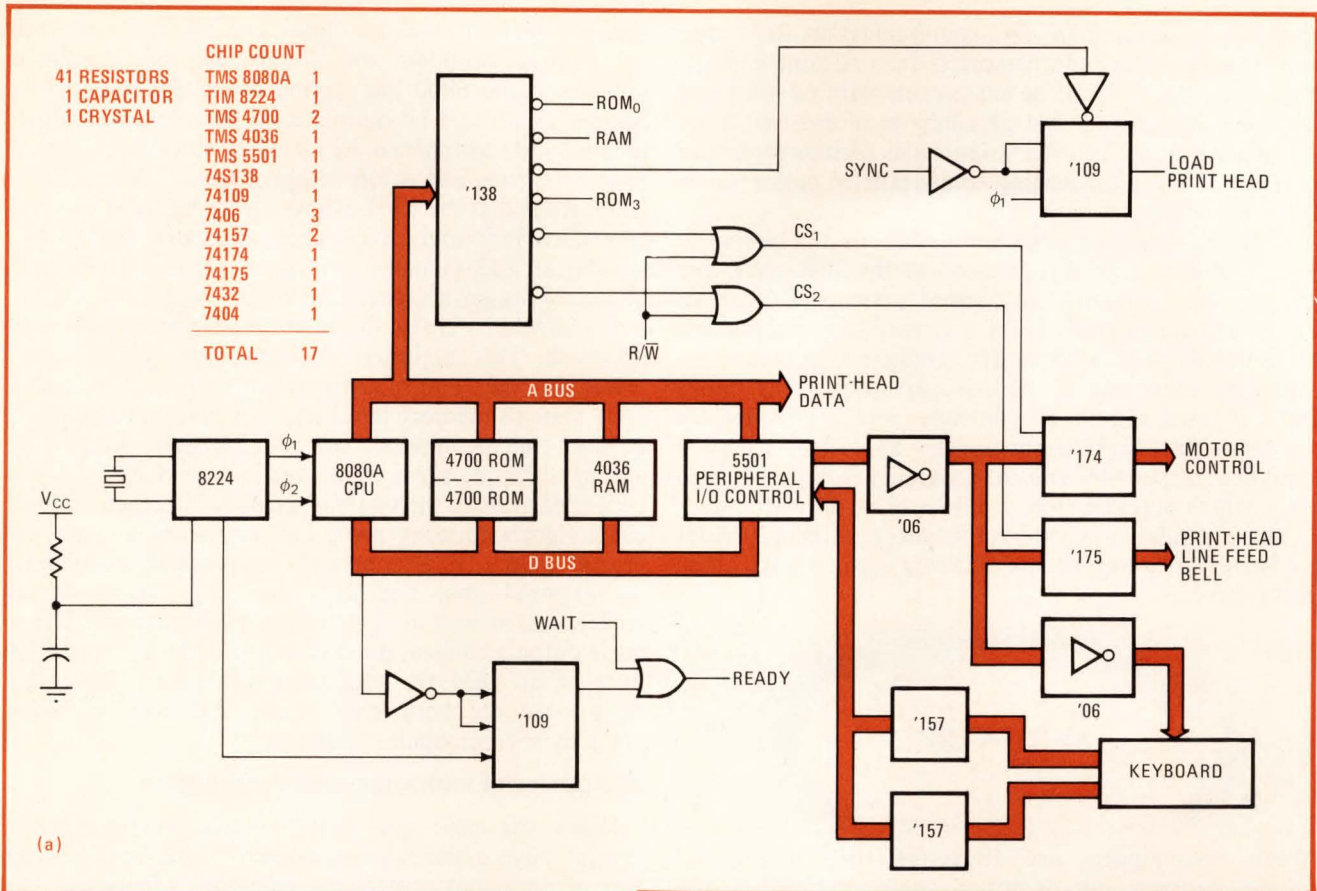

2. Cost-cutter. The 8080A-based design for this TI data terminal (a) requires 17 ICs, 41 resistors, a crystal, and capacitor. But the version designed around the 9940 (b) needs only one 9902 asynchronous communications controller and fewer passive devices.

rates are required, since the processor must detect the leading edge of the start bit and then accurately determine the center of the bit to establish a sampling point for the following bits.

If a capacitive keyboard is to be used, some additional hardware is required. In this case the eight keyboard outputs must be multiplexed into an analog detector circuit, which can process the low-level outputs of the capacitive keyboard. The 8048 controls both the multiplexer and the detector, gating the latter and controlling its gain to give the required hysteresis characteristics. In this case a 4-to-16 decoder scans 128 keys.

One-chip types due next year

Right now there are three principal one-chip 8-bit designs on the market, but a raft of new devices will be forthcoming throughout 1978 (again, see Table 1). The trend is to more I/O complexity, larger program ROMs, and larger scratchpad RAMs, with 2 and 4 kilobytes of on-chip ROM and 128 bytes of on-chip RAM in the offing.

The most powerful one-chip microcomputer in design is Zilog's Z-8, an 8-bit microcomputer that can execute a powerful subset of Z-80 instructions in as little as 1.5 microseconds. This single-5-volt part will have 2 kilobytes of ROM plus random-access storage as large as in any one-chip microcomputer—128 bytes. Also included on the chip are four 8-bit parallel I/O ports, a serial I/O

receive data serially until a message is complete. Alternatively, the processor can be put into an echo mode, where it immediately sends back received data bit by bit to the sender. Then actually to send code, the device is simply set to the bit range required for the serial code and then uses one I/O pin for serial output of the word, including its start and stop bits.

Receiving is less easy, for the input of a serial code is more involved. This is particularly so when high baud

port for interfacing to data-communication lines, and two timer/counters and prescalers for real-time control. Moreover, the Z-8 will be expandable with 64 kilobytes of external data RAM and 64 kilobytes of external ROM. To cap all, it can provide seven levels of interrupts and unlimited subroutine nesting—unparalleled performance in a single chip.

Another powerful one-chip device in the works is Intel's 8049, a 2-kilobyte version of the 8048 that, like the 48, can be used in expanded systems with all of Intel's LSI peripherals. With it a user can upgrade his 8048-based system without developing new software.

On the other end of the one-chip spectrum is Intel's 8021, a stand-alone 8-bit controller that is intended for very low-cost applications in the \$3 range, where a minimum of memory and I/O capability is required. This chip, which operates from a subset of 8048 instructions, is not expandable in external memory, although its 21 I/O lines can be expanded by making use of a companion 8243 I/O chip.

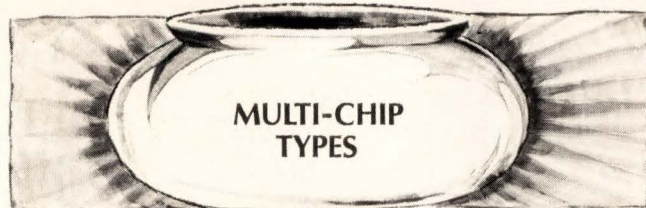

While one-chippers are attracting the attention of system designers for dedicated controller applications, some users are finding that they lack the power for handling high throughput applications, especially for intelligent terminals and industrial process control, and are turning to a two-chip approach. Fairchild's F-8 system is, of course, the oldest of these two-chip designs and has found many uses in intelligent terminals and video games. National's SC/MP microcomputer system is another popular system of this type. This year two new two-chip designs will be forthcoming: Motorola's 6802/6846 and Signetics' 2650A/2656 (Table 3).

What makes these two-chip systems so attractive is that unlike most one-chip microprocessors, apart from the 9940, they are expandable directly into three-or-more-chip systems without software changes. For example, Motorola's 6802 is an 8-bit microprocessor that contains all the registers and accumulators of the 6800,

plus an internal clock oscillator and driver. Used with the companion 6846, the system can be interfaced directly to the 6800 bus, giving the designer not only full-performance 8-bit bidirectional data buses on which to hand 6800 peripherals, but also two chip-select lines, a read-write line, and a full complement of address lines. This means that the 6802 can be used initially in low-end controller jobs and then, when expanded with 6800 peripheral and memory I/O chips, can be fitted with unlimited program capacity and 65 kilowords of RAM.

Expandability is also the key to the Signetics' two-chip approach. The minimum microcomputer system comprises just the 2650 microprocessor and the companion 2656 systems memory interface chip, whereas a general-purpose microcomputer can be designed simply by adding external ROM, RAM, and I/O packages. In the expanded system, the systems memory interface supplies clock signals to ROM, RAM, and CPU from an external crystal source. It also provides chip-enable commands for external ROM and RAM and any LSI peripheral controllers, as well as four bidirectional data bits. Since these outputs connect directly to the external chips with little or no need for additional interfacing chips, this design reduces both chip count and cost in many complex microcomputer systems.

The powerful midrange microcomputers

While the new one- and two-chip microcomputer designs have expanded the capability and reduced the cost of dedicated controllers, enhanced versions of the traditional multichip families are providing even greater processing power for general-purpose microcomputer applications. Indeed, the 2- and 3-MHZ versions of the 6800 family, the 4- and 5-MHZ versions of the 8085 family, and the 4-MHZ version of the Z-80 family are all advancing into the middle- and high-performance ranges of microcomputer designs. These systems offer higher throughput, more memory-handling capability, and greater ease of controlling ever larger numbers of complex peripherals, all with fewer chips and at less cost than the original designs.

For example, in system configurations based on the 8080A, the most widely used microcomputer system in existence today, the upgraded MCS 85 system or an equivalent Z-80 system each more than halves the parts count of the 8080A approach yet more than doubles the processor throughput while using 25% to 50% less program storage space (Fig. 3a, b, and c). This is the result partly of more efficient CPU design, which includes all timing and I/O control logic on the one chip, and partly of a more efficient, multiplexed data bus that can handle two to three times as many peripheral devices as the original 8080A design. Moreover, both the 8085 and Z-80 instruction sets are much more powerful, including the entire repertoire of the 8080A plus respectively 50 and 80 additional instructions.

Also beefed up in the new designs is real-time interrupt capability, thanks to additional internal registers on the CPUs and special control circuitry for extremely fast context switching. This is useful for minicomputer-type data-processing systems, where 7, 8, and sometimes 10 levels of interrupt and routine nesting must be accommo-

TABLE 3: TWO-CHIP MICROCOMPUTER SYSTEMS

Motorola 6802/6846	Mostek 3856/3857 Fairchild 3850/3851	Intel 8035/8355	TI 9972/9980	Signetics 2650A/2656
2 kilobytes of read-only memory	1 or 2 kilobytes of ROM	2 kilobytes of ROM	1,920 bytes of ROM	2 kilobytes of ROM
128 bytes of random-access memory	64 bytes of RAM	64 bytes of RAM	128 bytes of RAM	128 bytes of RAM
8 input-output lines	32 I/O lines	16 I/O lines	10 I/O lines	10 I/O lines
+5-V supply	+5-V, +12-V supply	+5-V supply	±5-V supply	+5-V supply
Board emulator	Board emulator	Erasable-programmable-ROM version	Board emulator	Board emulator

Source: Signetics

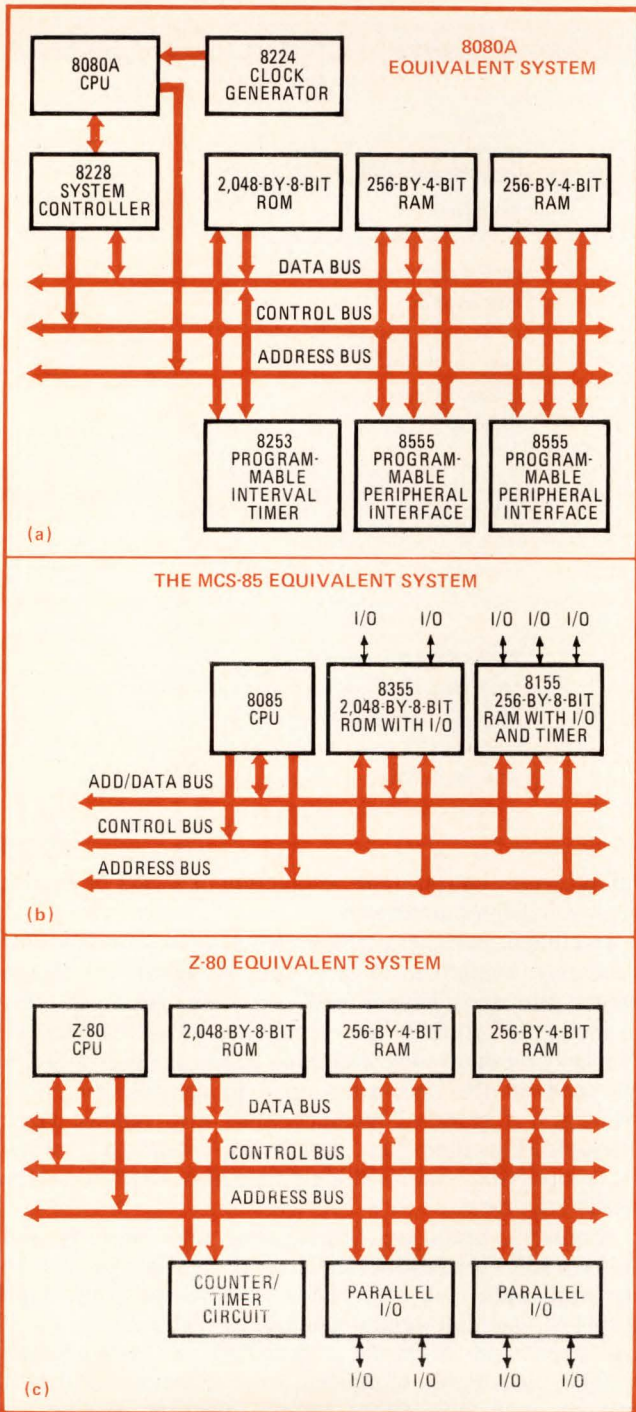

3. Enhancements. Mid-range families have improved dramatically in performance, thanks to enhanced CPUs. For instance, 8085 (b) and Z-80 (c) system designs offer 24% to 40% more performance than their parent, the 8080 (a), with fewer parts and less RAM.

dated. Also, both the 8085 and the Z-80 reduce the cost of interfacing the CPU to large amounts of external memory, another minicomputer grade of feature that is required in large-system implementation.

To do this, the CPUs have been fitted to provide all refresh and timing signals for directly driving dynamic memories, making it possible to use low-cost standard 4-k and 16-k RAMs in all system applications. These enhanced systems also reduce I/O costs by including

general-purpose programmable I/O circuits, which carry all the logic required to realize fast I/O transfers with minimal CPU overhead.

A family with renewed vigor is the 6500 8-bit general-purpose microcomputer originally offered by MOS Technology Inc. but now by Rockwell Microelectronics Group and Synertek, too. Widely held to perform as well as any general-purpose byte-oriented n-channel microprocessor, the 6500 options include five 40-pin microprocessors with on-board clock oscillators and drivers, plus four microprocessors driven by external clocks.

The on-chip clock versions are aimed at high-performance, low-cost applications where single-phase crystal or RC inputs provide the time base. The external clock versions are geared for the multiprocessor system applications where maximum timing control is mandatory. All versions of the microprocessors are available in 1-MHZ and 2-MHZ maximum operating frequencies. All are software-compatible within the group and bus-compatible with the 6800. (It is a 28-pin three-chip design that is being used by Atari Inc. for its well publicized non-video games.)

Included in the 6500 family is a host of matched peripherals that form an integrated microcomputer system. For example, Rockwell and Synertek are now supplying a peripheral interface adapter (the 6520) containing two 8-bit bidirectional data ports plus four control interrupt lines. There is a communications-oriented peripheral (the 6522) that has the PIA functions plus two interval timers plus one 8-bit serial I/O port. For large systems there is the 6530 memory-and-input/output-and-timer chip, which contains two 8-bit ports, one timer, 1,024 bytes of ROM and 64 bytes of static RAM. Finally there are a RAM extender chip and an external 2-kilobyte ROM chip and 1-k-by-4-bit static RAM chip.

A family of families

While most microcomputer suppliers have concentrated on one or two families of parts, National Semiconductor has introduced a wide range of 4-, 8- and 16-bit families: from the low-end refitted SC/MP system, through the mid-range 8080, to the high-end 16-bit PACE system. And to tie the families together, the Santa Clara-based manufacturer has defined a system bus standard that allows a designer to use any members of any family together in a standardized design.

Thus, National offers low-, middle- and high-range capability in a well-defined system standard. For example, a user can hang SC/MP or National's 2650 CPUs onto an 8080 system bus for distributed multiprocessing applications in point-of-sale or communications systems. Meanwhile, PACE can be used on the same bus, with SC/MPS, or 8080s, or any National peripherals for implementing high-end 16-bit process-control applications.

National also offers many bus-compatible peripherals, including CRT, keyboard, SDLC, and memory-controller chips. The company has also culled from its extensive line of TTL parts those that perform useful microcomputer functions, such as the 8-bit I/O port (8212), a clock generator and driver (8224), and a single-chip system controller and bus driver (8228 and 8238).

Also being boosted with new peripherals and matched

memory parts in the mid-performance range are two C-MOS processors: RCA's 8-bit 1802 Cosmac family and Intersil's IM6100 12-bit family that emulates PDP-8 instructions (it is also being supplied by Harris). Throughout the year, RCA has been adding extensively to its family with several memory and I/O circuits that provide a unified LSI approach to C-MOS system design. The 1800 family now includes the 1802 CPU, the 1831 and 1832 static mask-programmable 512-by-8-bit ROMs, the 1824 32-by-8-bit static RAM, the 1821S silicon-on-sapphire, 1,024-by-1-bit static RAM, the 1822S silicon-on-sapphire, 256-by-4-bit RAM, the 1852 latching byte input/output circuit, a universal asynchronous receiver/transmitter, a multiply-divide unit, 3-bit latch decode circuits, a bus buffer, a 256-by-4-bit C-MOS RAM, a 128-by-8-bit RAM, and a programmable bit I/O circuit.

For 1600 systems a designer can choose from a host of compatible C-MOS chips that work directly with the 1600 CPU. The 6561 is a 150-ns, 1,024-bit static RAM that is organized in a convenient 256-word-by-4-bit configuration. The 6312 is a 1-k-by-12-bit mask-programmable C-MOS ROM. A parallel-interface element (6101) provides a universal means of interfacing a wide variety of peripheral devices to the 6100 CPU. In addition, a universal asynchronous receiver/transmitter (6402/03) links the processor to serial data channels. Soon to be available are a C-MOS 4-k erasable programmable ROM and two 4-k high-speed static RAMs.



Performance aside, perhaps the most important new development in mid- and high-performance microcomputer systems is the intelligent peripheral chip that fits directly onto the system bus of these enhanced designs. Table 4 lists a sampling of these chips. These low-cost LSI formats cover a wide range of specific applications that once required many TTL packages.

While there are differences in the design of the peripherals from various suppliers, they all share the same essential features:

- Like the processors themselves, they operate from a single +5-v power supply and are TTL-compatible.
- They can each serve many different applications because each is capable of adopting a wide range of configurations within its designated application area. In other words, they are programmable, the system's software writing the necessary instructions into their on-chip registers and latches.
- They can interface with the system's main data bus directly via commands from the CPU to data ports on each chip. The command port through which the peripheral device is programmed with one of its multiple modes also serves as a data port through which transfers of operating data are made.
- Communication between peripheral and CPU is interrupt-driven. That is to say, the peripheral sends the CPU

TABLE 4: MICROCOMPUTER PERIPHERALS

General-purpose peripherals
decoders
latches
priority interrupt
bus drivers
serial communication interface
parallel communication interface
interval timer
direct-memory-access controller
interrupt controller
analog-to-digital converter
digital-to-analog converter
Memory-oriented peripherals
random-access-memory with input/output
read-only memory with I/O
erasable programmable ROM with I/O
Dedicated peripherals
floppy-disk controller
synchronous data-link control protocol controller
programmable cathode-ray-tube controller
programmable keyboard/display interface
arithmetic units
media encryption converters

an interrupt request upon completion of a task or receipt of external communication.

Intelligent peripheral chips such as these are only now becoming available, or are still in advanced design stages. But users have already expressed strong interest in incorporating them into their most advanced designs. Not only do these programmable chips take ever more of the load off the CPU, allowing it to control ever more packages of external memory, they also replace large amounts of medium- and small-scale integrated circuitry, simplifying system design and also shortening the hardware process.

Similarly, users are finding that they simplify and shorten software requirements, since they can be used to perform many of the routine functions—refreshing displays, scanning inputs, managing bit streams on serial I/O lines, and generally responding to asynchronous events—in a highly organized, routine manner. All of it can be done with either simple interrupt routines or polling techniques.

Typical of the intelligent peripheral chips is Intel's 8275 programmable cathode-ray-tube controller, which interfaces a CRT's raster-scan displays to 8080/8085 microcomputer systems. While its chip is extremely complex, cramming 26,000 transistors into a 40-pin package, using it is relatively straightforward. Its primary function is to refresh the display by buffering the information from main memory and keeping track of the display portion of the screen. It therefore provides raster timing, display row buffering visual attribute decoding, cursor timing, and light pen detection.

As shown in Fig. 4, it is designed to operate with an 8275 direct-memory-access controller and standard

character-generator ROMs for dot-matrix decoding. In this configuration, all functions except for the dot level timing, are carried out within the chip.

The block diagram of Fig. 4a presents the chip's basic functions. The programmable character counter determines the number of characters to be displayed per row and the length of the horizontal retrace interval. It is driven by the character clock (CCLK) input, a derivative of the external dot clock.

Besides keyboard/display, CRT, and memory controller peripherals, one of the hottest new peripheral areas is in data-communications interface chips. Remarkable examples are two data-communications links from Signetics Corp. and Standard Microsystems Corp. that can be programmed from virtually any 8- or 16-bit

microcomputer data bus. They do such tasks as formatting, receiving and transmitting serial data, generating multiple baud rates upon software command, controlling and monitoring modem hand-shaking features, and supplying remote and local loopback test options. They support various data line disciplines, such as BSC, HDLC, SDLC and start/stop.

Even more ambitious is Zilog's serial-I/O chip that fits directly onto the Z-80 bus and is programmable from Z-80 software. The SIO chip can do everything the other two can do: it can handle asynchronous, synchronous, and synchronous bit-oriented protocols, such as the IBM BiSync, HDLC, SDLC, as well as virtually any other serial protocol. Moreover, it can generate CRC codes in any synchronous mode, and can be programmed by the CPU for any traditional asynchronous format. In addition to all this, it can handle two full-duplex channels, or twice the capacity of any proposed communications interface peripheral design.

The internal structure of the SIO (Fig. 5) includes bus interface logic for the Z-80 CPU and internal control and interrupt logic for both duplex channels. In operation, the interrupt control logic determines which channel and which device within the channel has the highest priority for receiving automatic interrupt signals. Priority is fixed when channel A, say, is assigned higher priority than B, and the receiver/transmitter and external/status are assigned priority in that order within each channel.

Complementing the intelligent peripheral chips, which are software-adaptable to particular kinds of applications, is a controller chip from Intel Corp. that is fully user-programmable. A subset of the 8048 family, this 8141 part, which can be thought of as a single-chip slave, contains a complete microprocessor integrated with a system bus interface that allows one CPU to communicate asynchronously with many slaves. It can be used to control a wide variety of peripherals, making it the industry's first universal peripheral control component.

The chip's 8-bit central processor has an instruction set comparable to the 8048's. It has 1 kilobyte of ROM or erasable PROM, a 64-byte static RAM for read/write data

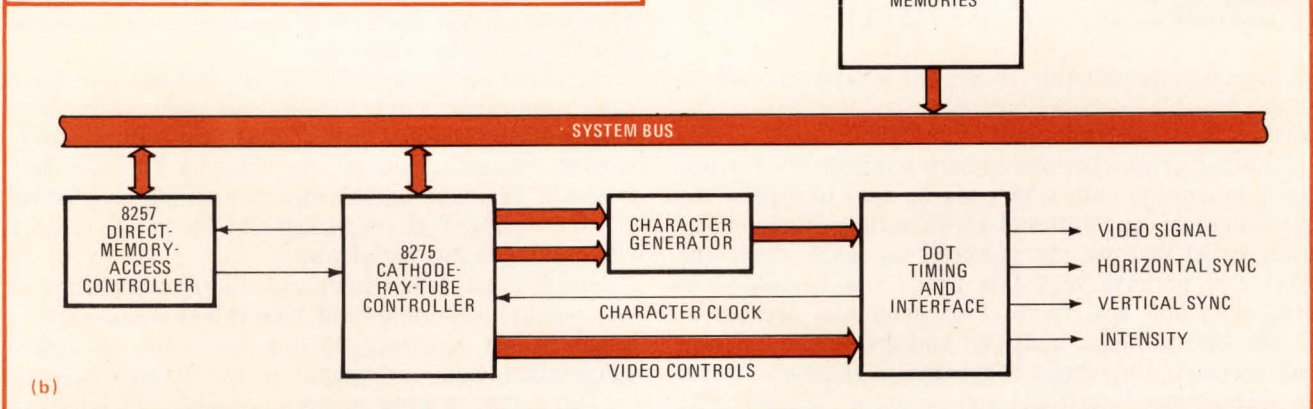
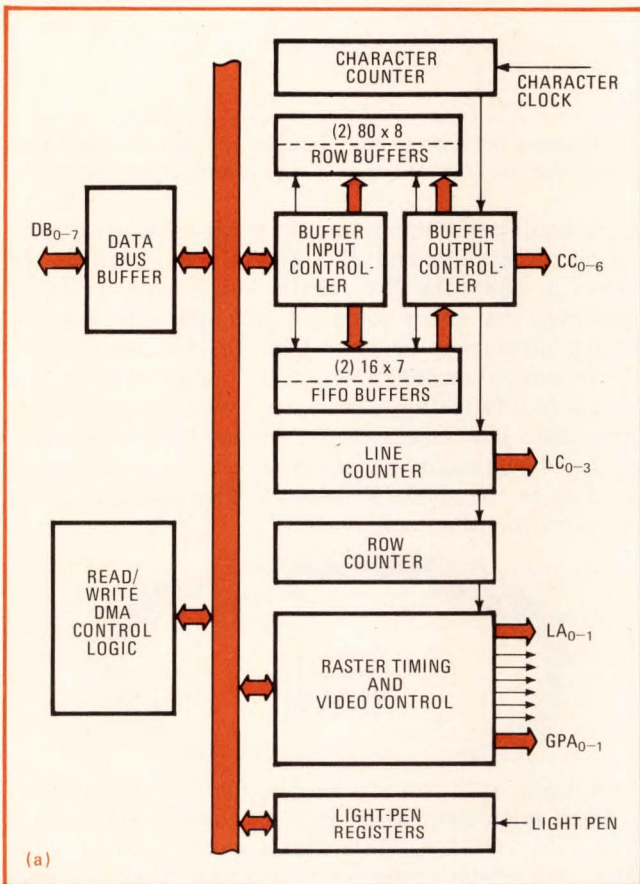

4. Controlling cathode-ray tubes. In CRT controllers such as Intel's 8275, the character counter determines the number of characters to be displayed and the length of the retrace interval. The system (b) is driven by a direct-memory-access controller.

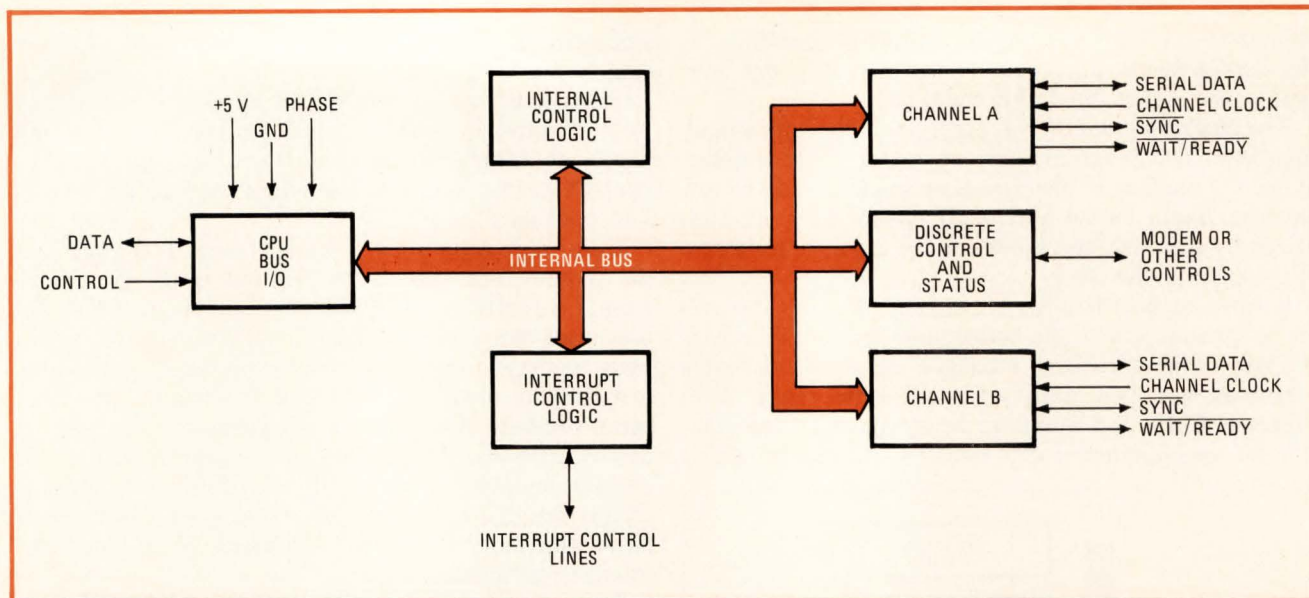

5. The link. Zilog's serial-I/O controller is the most ambitious of its kind. It manages not one but two full-duplex channels and can handle asynchronous, synchronous, and synchronous bit-oriented protocols, such as biSync and SDLC. In charge of the controller is the Z-80 CPU.

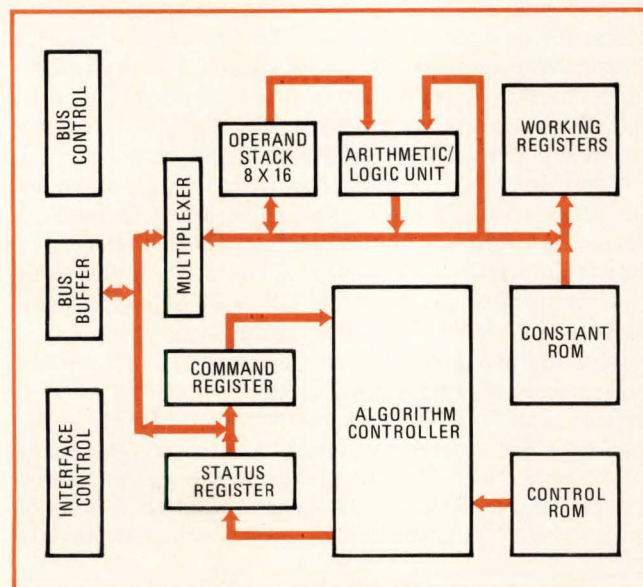

6. Extender. This 9511 peripheral from AMD extends the performance of byte-oriented mid-range microcomputers. In operation, all transfers including operand, results, status, and command information are transferred over an 8-bit bidirectional bus.

storage, a programmable 18-line I/O subsystem, an 8-bit programmable interval timer/event counter, two single-level vectored interrupts, and a clock generator.

Another unique peripheral chip is AMD's 9511 arithmetic processing unit, which can be used to expand the mathematical capabilities of a wide variety of microcomputer-based designs. As powerful as many CPUs, the 9511 can perform very fast fixed- and floating-point arithmetic and floating-point trigonometric operations. It can add, subtract, multiply, and divide and perform trigonometric and inverse trigonometric functions. It can do square roots, logarithms, and exponents. It can handle binary data formats and float-to-fixed and fixed-to-float conversions. In short, it can be used on almost any 8-bit

bus to boost performance into the minicomputer range.

Under the command of a central CPU, such as the 8080A or 8085, the 9511 can handle a wide variety of operations that either could not be handled by or would occupy too much of the CPU's time. In operation (Fig. 6), all transfers, including operand, result, status and command information, take place over an 8-bit bidirectional data bus. Operands are pushed onto an internal stack and commands are issued to perform operations on the data in the stack. Results are then available to be retrieved from the stack.



Even while manufacturers beef up their mid-range byte-oriented microcomputer families, they are preparing a blitz into 16-bit designs. Manufacturers already out there with 16-bit families—TI with the 9900, National with PACE and IMP, and GI with its CP1600—will soon be joined by 8-bit manufacturers.

The shoot-out is expected to be bloody. The three major mid-range 8-bit families will add 16-bit CPU designs during the first half of next year—Intel adding its 8086, Motorola its 6809, and Zilog its Z 8000. These CPUs will be made as software-compatible as possible with the existing 8-bit chips, and all will operate directly with existing family peripherals.

Indeed, these 16-bit CPUs put microcomputer hardware solidly in the mid- and high-end of minicomputer design, which has requirements like double-precision computation, high throughput in the 10-MHz regions, and fast access to large memories of 64 to 256 kilobytes that cannot be handled by 8-bit processors.

How the new 16-bit designs, derived as they are from

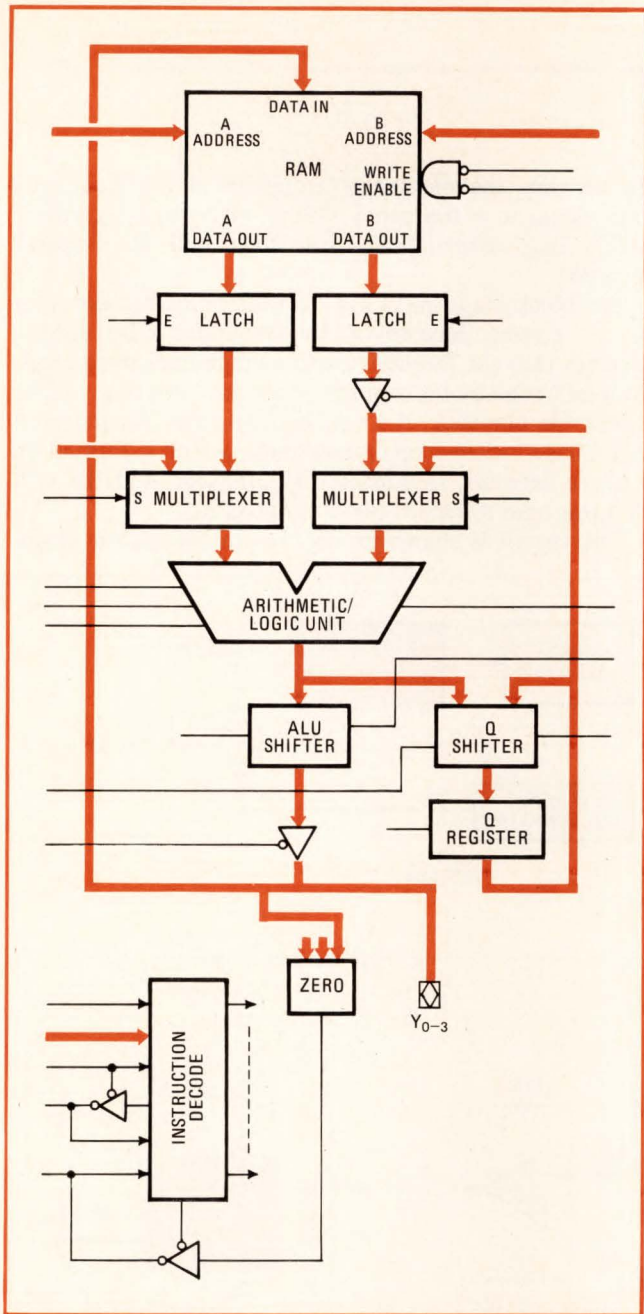

7. Simpler still. The next-generation 2903 bit-slice microcomputer, besides performing better, is easier to design with, especially in arithmetic-oriented systems. Memory can be expanded indefinitely, and a three-address architecture gives maximum flexibility.

an 8-bit orientation, will compare with existing 16-bit CPUs is the question users must grapple with. While details of the 16-bit newcomers are still sketchy, they will surely retain the basic register-to-register architecture used on the 8-bit chips. In those register-oriented designs, program and data spaces are contained in CPU registers—a stack configuration that provides routine manipulation.

On the other hand, TI's 9900 architecture uses a memory-to-memory configuration, with three working registers maintained in the CPU and with program and data registers maintained in external memory. This is much closer to minicomputer architecture, and conse-

quently TI designers feel they have the edge in 16-bit applications.

Meanwhile, TI is producing a large number of support peripherals for its 9900 family, including the 9902 asynchronous communications controller, the 9903 synchronous communications controller, the 9904 clock generator, the 9905 8-to-1 data multiplexer (formerly the 74LS259), and the 9906 8-bit addressable latch (formerly the 74LS148).

National, too, has increased its strength in 16-bit types with its 8900 CPU, an n-channel version of its early PACE design. Like that design, it is a true 16-bit central processing unit: it makes use of 16-bit instruction words and 16-bit data words and features a powerful, efficient, and flexible set of 46 instructions.

Don't forget bipolars

While new n-MOS microcomputers move up in word length and performance, the highest end of the scale is still covered by the bipolar microcomputer. The most popular here are 4-bit-slice families, led by AMD's 2900—which will be made by a raft of suppliers—and TI's 481 family, a relative newcomer, followed by Intel's 3000 2-bit slice. Built with low-power Schottky LSI technology, these families are microprogrammable and offer the flexibility unique to variable-length designs.

Complementing these are other bipolar families such as Motorola's 10800 ECL bit-slice family for very high performance and Fairchild's bipolar Macrologic series, which contains the 9400 I²L 16-bit CPU. TI has an I²L version of its 9900, while Signetics has its 8-bit 8X300 fixed-word microprocessor built with Schottky TTL technology. It has found increasing applications in the gap between the n-MOS and bit-slice designs.

Because of the number of systems that have 2900 design-ins, supplier action here is fierce, with new higher-performing chips in the offing. National, for example, is entering the market with enhanced 2900A CPU designs, like Signetics and others. Meanwhile, AMD, who pioneered the family, is staying ahead by offering faster 2901A CPUs and new-generation CPUs such as the 2903. The 2903 (Fig. 7) performs all the functions of the 2901 while providing a number of enhancements that make it more flexible and easier to use:

- Expandable register file. Like the Am2901A, the Am2903 contains 16 internal working registers arranged in a two-address architecture. But the Am2903 includes the necessary hooks to expand the register file externally to any number of registers.
- Built-in multiplication logic. Performing multiplication with the Am2901A requires a few external gates—all contained on chip in the Am2903.
- Built-in division logic. The Am2903 contains all logic and interconnects for execution of a nonrestoring, multiple-length division with correction of the quotient.
- Built-in normalization logic. It can simultaneously shift the Q register and count in a working register.
- Built-in parity generation circuitry. The Am2903 can supply parity across the entire ALU output for use in error detection and CRC code generation. □

Reprints of this two-part article will cost \$4.00 from Electronics Reprint Dept., P. O. Box 699, Hightstown, N.J. 08520. Copyright 1977, Electronics, a McGraw-Hill publication.

Frequency modulator extends tape recorder's f response

by W. B. Warren and W. L. Lively
TRW Subsea Petroleum Systems Inc., Houston, Texas

Tape recorders used in low-frequency data acquisition systems are, not surprisingly, expensive. But this simple frequency-modulator circuit extends to dc the effective low-frequency response of any inexpensive tape recorder.

To do this, the modulator translates a low-frequency data signal to a frequency falling within the recorder's limits, thus ensuring that the data will be properly recorded.

The block diagram in Fig. 1a illustrates the operation of the circuit. Recording low-frequency data simply requires that the frequency of a voltage-controlled oscillator be varied by the amplitude of a low-frequency input signal. On playback, the recorded data can be recovered by a phase-locked-loop demodulator, which is formed by a phase detector, frequency discriminator, and the vco that was used to record the original data.

The circuit is shown in Fig. 1b. In the record mode,

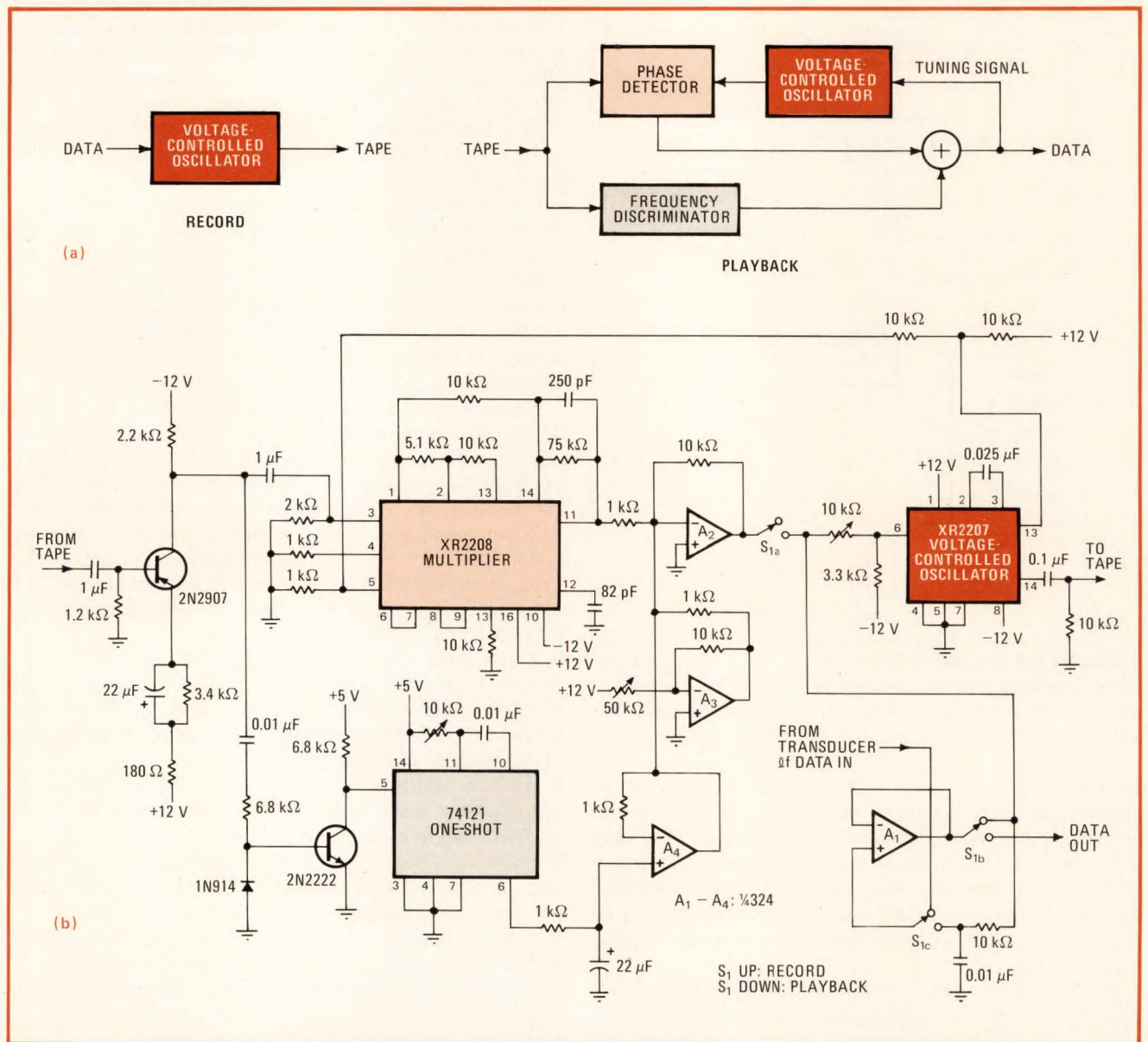

Data translation. Low-frequency data may be recorded on an inexpensive tape recorder if the signal is first modulated to a higher frequency. Signal is recovered from recorder by demodulation, using same VCO (a). Modulator uses four chips and two transistors (b).

data signals are introduced to amplifier A_1 , which in turn drives the Exar XR2207 vco. A 0-to-10-volt data signal will vary the vco frequency from 10 to 5 kilohertz so that the corresponding frequencies can be recorded.

On playback, the recorded data is presented to the 2N2907 buffer, then introduced to one input port (pin 3) of the XR2208 multiplier, which serves as a phase detector. Driving the other input port at pin 5 is the vco. The output signal from the phase detector is the demodulated waveform produced by the multiplication of the playback signal times the output of the vco.

The 74121 monostable multivibrator (one-shot) serves as a simple frequency discriminator, which drives the low-pass filter formed by the 1-kilohm resistor and the 22-micro-farad capacitor. The filter produces a voltage proportional to the frequency of the signal from the tape recorder. The addition of the discriminator to the circuit provides for rapid and reliable acquisition of the recorded data and reduces the dynamic range over which

the phase-detector portion of the loop must operate.

The signals produced by the frequency discriminator and the phase detector are summed by A_2 through A_4 to generate the control voltage for the vco. Therefore, the output signal, which is the control (tuning) voltage, is a dc voltage equal to that originally recorded. Using the same voltage-controlled oscillator for both record and playback modes ensures that vco tuning nonlinearities have a negligible effect on system linearity.

The characteristics of the XR2207 are very stable with respect to supply-voltage and temperature variations. The primary sources of error between the record and playback signals will be those caused by tape stretch and the tape recorder's variations in speed. Both of these effects may be minimized by adjusting the potentiometer at pin 6 of the XR2207 to yield as large a frequency swing as possible for the range of signals being recorded. Better than 1% accuracy can be obtained with this circuit, even if an inexpensive tape recorder is used. □

Programming a microcomputer for d-a conversion

by Richard T. Wang

Department of Zoology, University of Texas, Austin, Texas

If the speed of conversion is not an important consideration, a microcomputer can be used for digital-to-analog number conversion with the aid of this simple pulse-width modulation program. A resistance-capacitance filter and a latch, which may be connected to any one pin of the microcomputer's output ports, are the only items of microprocessor hardware required. Almost any strip-chart recorder can be used to record the filtered output voltage. Although intended for the plotting of bar graphs, histograms, and spectrograms from data stored in memory, the program needs only slight modification to be able to handle real-time data.

The program in the table was written for the Zilog Z-80 microcomputer system. All data for the graphs to be plotted is stored as an array in memory. The first two bytes of the array contain the number of data elements stored in the area labeled ARRAY. These bytes are loaded into registers B and C, which keep track of the number of bytes in ARRAY remaining to be sampled. The elements of ARRAY are loaded into register A and passed to a timing loop one at a time, where each will eventually be converted into an analog voltage.

The timing loop uses the alternate (primed) registers. Register B' is loaded with a number (N) determined by the relationship $N=PS/E$, where E is the number of elements per inch recorded for a given chart speed (S) and output pulse rate (P) to the RC filter. B' contains the number 192—the number of pulses per element (N) needed to ensure that 50 elements per in. are recorded for a given chart speed of 30 seconds/in., and a pulse rate of 320/s.

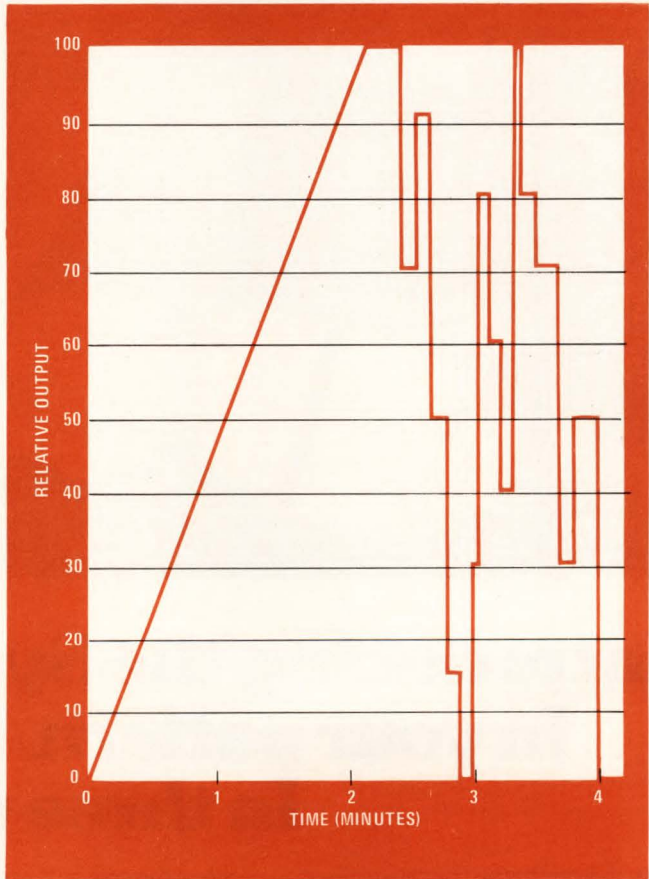

System response. Typical graph is accurately reproduced by Heath EU-205-11 strip-chart recorder. System linearity is confirmed with a ramp-test pattern, as shown on left. Right half shows a sample histogram. Total recording time is 4 minutes.

Register E' is loaded with a selected value of 201, a number that is one greater than the largest number that may be plotted. E' is decremented through a loop consisting of six instructions. A NOP instruction is included for timing compensation. When E' equals the



Introducing the Synertek 32K ROM. In your pattern. In your hands. In three weeks.

We can deliver this fast because all we have to do are the final two mask steps to program your pattern. With all prior masking operations done, and wafers in inventory, you save a full four weeks — almost off-the-shelf delivery on your custom part.

And our 32K ROM packs a wallop. Over 40,000 transistors. More density than any other available chip in the world. And it does it in a 24 pin DIP, plastic or ceramic. One more thing.

Since the pin-outs are very similar to the standard 16K ROM, you can replace two 16Ks with only minor modifications. Or none at all.

Our 32K ROM puts us in the forefront of ROM technology. The highest complexity production chip in the industry . . . 450-nsec access time . . . fully compatible with our 6500 and other microprocessors.

The Synertek SY2332 32K ROM. Our show is on the road. And,

when you consider the high speed and how fast you can be in production, the price of admission is practically peanuts.

For complete specs and pricing, contact Bob Cushman at Synertek, 3050 Coronado Drive, Santa Clara, California 95051. Telephone (408) 984-8900. TWX: 910-338-0135.

Synertek

Electronics / December 8, 1977

contents of A, the state of the output is changed from a 0 to a 1 and begins to charge the capacitor in the RC filter. This continues until E' decrements to zero. At this time the output returns to 0. E' then returns to 201, and the process repeats until 192 pulses are generated for that element. The next element then undergoes an identical process until the entire array has been processed. The output pulse width (W_i) is related to the digital numbers (D_i) for a system clock at 2.5 megahertz by $W_i = 15.2 D_i$ where W_i is given in microseconds.

The critical timing in this program occurs between the START and TERM instructions. When the number to be converted is 1 (the smallest number that can be encoded), this instruction sequence takes 38 clock periods, or T states, exactly the same as that required by the START-TERM loop. The program is thus written so that multiples of 38T are added through the loop for numbers

greater than 1, ensuring a linear relation of the output pulse width to the digital number stored.

With the output pulse rate of 320/s, an RC filter with a time constant equal to or greater than 3 milliseconds is sufficient to smooth the output voltage. To calibrate the system, the input to the chart recorder should be temporarily grounded, and its pen position should be set to zero. ARRAY is then filled with C8 (hexadecimal), the full-scale value, and the program is initiated. The recorder sensitivity control is then adjusted for a full-scale indication.

The figure shows a graph recorded on a Heath strip chart instrument. The ramp voltage is intended to display the system's linearity. □

Designer's casebook is a regular feature in *Electronics*. We invite readers to submit original and unpublished circuit ideas and solutions to design problems. Explain briefly but thoroughly the circuit's operating principle and purpose. We'll pay \$50 for each item published.

Z-80 PULSE-WIDTH-MODULATION PROGRAM FOR DIGITAL-TO-ANALOG CONVERSION

LOC	OBJ CODE	STMT	SOURCE STATEMENT
		1	*H D/A CONVERSION
		2	; SUBROUTINE DAC: D TO A CONVERSION BY PULSE
		3	; WIDTH MODULATION. THE GRAPH TO BE DISPLAYED
		4	; IS SET UP IN ARRAY. THE FIRST TWO BYTES
		5	; INDICATE THE LENGTH OF ARRAY. ANY NUMBER
		6	; GREATER THAN FULL SCALE (200 DECIMAL) WILL
		7	; BE DISPLAYED AS ZERO.
		8	;
		9	ARRAY EQU 3000H ;ADDRESS OF ARRAY
2300		10	ORG 2300H
2300	210030	11	DAC LD HL,ARRAY ;ADDRESS OF ARRAY IN HL
2303	4E	12	LD C,(HL) ;FIRST TWO BYTES
2304	23	13	INC HL ; INDICATE LENGTH
2305	46	14	LD B,(HL) ; OF ARRAY
2306	23	15	DSLOOP INC HL ;DISPLAY LOOP
2307	7E	16	LD A,(HL) ;NUMBER TO BE DISPLAYED
2308	D9	17	EXX ;GET ALTERNATE REGISTERS
2309	06C0	18	LD B,192 ;REFRESH CYCLES
230B	0E01	19	LD C,01 ;OUTPUT PORT ADDRESS
230D	1620	20	LD D,100000B ;BIT 5 AS OUTPUT PIN
230F	1EC9	21	SUBDAC LD E,201 ;SET E TO MAXIMUM + 1
2311	1D	22	LOOP DEC E ;E AS TIMING COUNTER
2312	280B	23	JR Z,TERM ;TO TERMINATE PULSE
2314	BB	24	CP E ;A EQUALS TO E?
2315	2803	25	JR Z,START ;IF YES, START PULSE
2317	00	26	NOP ;TIMING COMPENSATION
2318	18F7	27	JR LOOP ;LOOP IF NOT EQUAL
231A	ED51	28	START OUT (C),D ;START OUTPUT PULSE
231C	C31128	29	JP LOOP ;CONTINUE LOOP
231F	ED59	30	TERM OUT (C),E ;TERMINATE PULSE
2321	10EC	31	DJNZ SUBDAC ;REFRESH UNTIL B ZERO
2323	D9	32	EXX ;GET BACK MAIN REGISTERS
2324	0B	33	DEC BC ;END OF ARRAY?
2325	79	34	LD A,C
2326	B0	35	OR B
2327	20DD	36	JR NZ,DSLOOP ;IF NOT, SHOW NEXT NUMBER
2329	C9	37	RET
		38	END

Extending calculator programs to staggered tuned circuits

Part 2 of two-part article gives procedures for designing Butterworth, Chebyshev networks

by Albert E. Hayes Jr., Fullerton, Calif.

□ Designers of cascaded tuned circuits have traditionally been confronted with a series of complex and tedious calculations, often involving trial-and-error procedures necessitated by the number of tuned-circuit variables to be considered. But now, a series of programs for tuned-circuit design has been created for the HP-67/97 scientific calculator that can easily solve the complex equations and eliminate the procedural guesswork in design problems of this nature.

In Part 1, equations for designing simple and synchronous tuned LC circuits were first developed into formulas and thence into step-by-step design procedures [*Electronics*, Nov. 24, p. 118]. As discussed there, the synchronously tuned circuit, which is formed by cascading several tuned circuits at the same resonant frequency, has a sharply peaked output voltage at resonance and is used in only a relatively few cases nowadays.

There are, however, many applications where a broad response is desired. Such a characteristic may be achieved by tuning each circuit of a cascaded network to one of a series of frequencies above and below the nominal center frequency of the passband. Two types that thus provide a flat-topped characteristic are known as the Butterworth and Chebyshev responses.

The Butterworth response

The Butterworth response is maximally flat through the passband (Fig. 1a). It may be attained with an odd or an even number of single tuned circuits, as shown in Fig. 1b and 1c. In both diagrams, f_o is the nominal center frequency and $(f_a)_m$ and $(f_b)_m$ denote the specific frequencies of the m th stage above and below f_o , respectively. Note that no individual circuit can be tuned to f_o when the number of circuits is even.

Before considering the defining equations for the Butterworth case, review the notation used for cascaded tuned circuits as listed in Table 1.

Three classical equations that apply to the Butterworth response must be rearranged in order to develop the design procedure. In its usual form, the first is so unwieldy as to be useless from the viewpoint of the circuit designer:

$$\frac{V}{V_j} = \left[1 + \left(\frac{V}{V_i} - 1 \right) \left(\frac{BW_j}{BW_i} \right)^{2n} \right]^{1/2} \quad (1)$$

where V/V_j is the relative amplitude at bandwidth BW_j with reference to the peak value V , and V/V_i is the relative amplitude at reference bandwidth BW_i .

The second and third equations relate the staggered tuned frequencies to the bandwidth and the number of tuned circuits:

$$(f_a - f_b)_m = \frac{BW_i}{[(V/V_i)^2 - 1]^{1/2n}} \cos \left(\frac{2m-1}{n} 90^\circ \right) \quad (2)$$

$$(f_a + f_b)_m = 2f_o \quad (3)$$

An additional equation, which yields the Q of the m th tuned circuit, is needed:

$$Q_m^{-1} = \frac{BW_i/f_o}{[(V/V_i) - 1]^{1/2n}} \sin \left(\frac{2m-1}{n} 90^\circ \right) \quad (4)$$

These four equations can be manipulated in an orderly

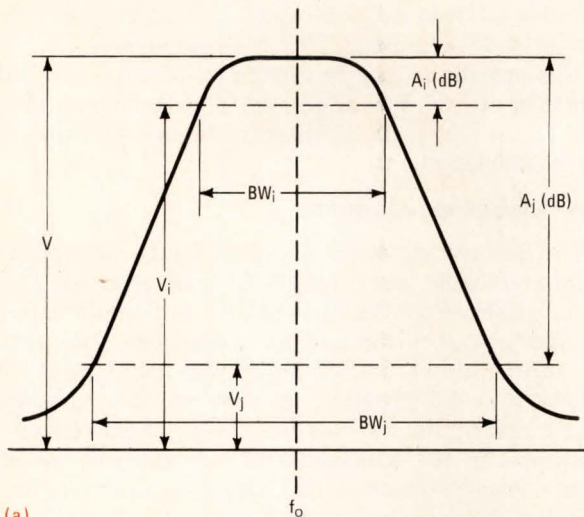

(a)

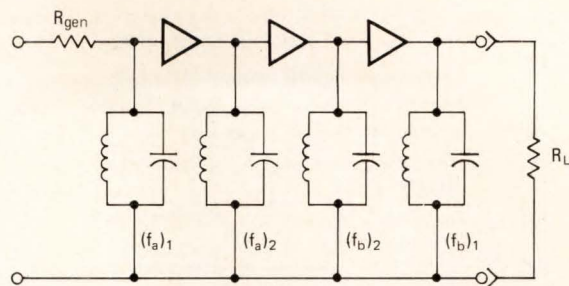

n IS EVEN

$$m_{\max} = n/2$$

(c)

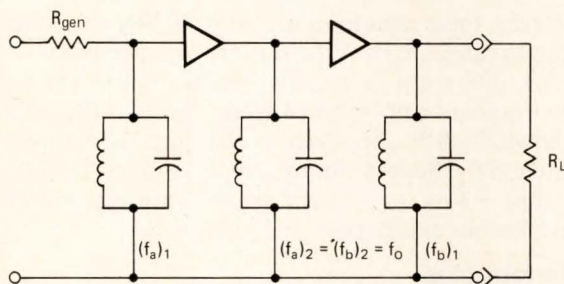

n IS ODD

$$m_{\max} = (n+1)/2$$

(b)

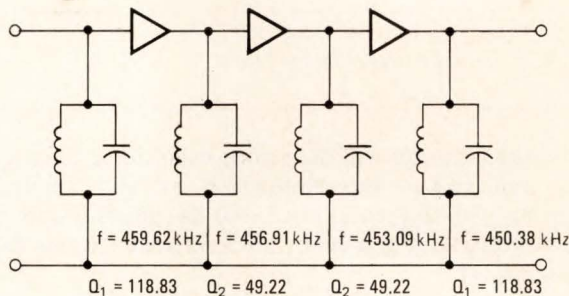

$$f_0 = 455 \text{ kHz}$$

$$-3\text{-dB BANDWIDTH} = 10 \text{ kHz}$$

$$-30\text{-dB BANDWIDTH} = 30 \text{ kHz}$$

$$-60\text{-dB BANDWIDTH} = 56.27 \text{ kHz}$$

$$\text{ATTENUATION } 20 \text{ kHz OFF}$$

$$\text{RESONANCE} = 48.14 \text{ dB}$$

(d)

1. Broad response. Butterworth characteristic has flat-topped crest at center frequency (a), which may be attained by using staggered tuned stages. When n is odd, at least one circuit is tuned to f_0 (b). If n is even, no stage can be tuned to f_0 (c). Completed design of 455-kHz i-f amplifier discussed in text is shown (d).

manner, then presented to the calculator to determine:

- The number of tuned circuits needed for a specific response.
- The frequencies to which the circuits must be tuned.
- The Q of each tuned circuit.
- The attenuation at any arbitrary frequency that is outside of the band.

To find n and the resonant frequencies of the tuned circuits, Eq. 1 is rearranged thus:

$$n = \log \left[\frac{(V/V_i)^2 - 1}{(V/V_j)^2 - 1} \right] + 2 \log \frac{BW_j}{BW_i} \quad (5)$$

Adding Eqs. 2 and 3 together to eliminate $(f_b)_m$ yields:

$$(f_a)_m = \frac{0.5BW_i}{[(V/V_i)^2 - 1]^{1/2n}} \cos \left(\frac{2m-1}{n} 90^\circ \right) + f_0 \quad (6)$$

The resonant frequency of the lower-tuned circuit is then found from:

$$(f_b)_m = 2f_0 - (f_a)_m \quad (7)$$

The calculation for Q_m is handled directly with the inverse-function ($1/x$) capability of the HP-67/97 calculator, and the calculation for the attenuation (A_x) at a specified BW_x , or the inverse problem, finding BW_x given A_x , follows directly from rearranging Eq. 1:

$$BW_x = BW_i \left[\frac{(V/V_x)^2 - 1}{(V/V_i)^2 - 1} \right]^{1/2n} \quad (8)$$

This equation allows a selectivity plot to be generated for any system.

The preceding formulas form the Butterworth program, which is shown in Table 2.

A representative problem is the design of a 455-kilohertz intermediate-frequency strip having a bandwidth of 10 kHz at the -3 -decibel points and a bandwidth of 30 kHz at -30 decibels. Given this information

TABLE 1: CASCADED CIRCUIT NOTATION

A	= attenuation, in dB
A _i	= attenuation, from peak value, at BW _i , in dB
A _j	= attenuation, from peak value, at BW _j , in dB
A _x	= attenuation, from peak value, at BW _x , in dB (A _x and BW _x are unknowns)
BW _i	= bandwidth between the -A _i (dB) points on a response curve
BW _j	= bandwidth between the -A _j (dB) points on a response curve
BW _x	= bandwidth between the -A _x (dB) points on a response curve (A _x and BW _x are unknowns)
V	= voltage measured at peak of response curve
V _i , V _j	= voltage measured at the -A _i , -A _j (dB) points on a response curve (A _i = 20 log ₁₀ V/V _i)
f _o	= center frequency (nominal frequency of passband)
(f _a) _m	= resonant frequency of higher-tuned circuit of mth pair
(f _b) _m	= resonant frequency of lower-tuned circuit of mth pair
n	= number of tuned circuits in system
m _{max}	= number of pairs of tuned circuits in system if n is even, m _{max} = n/2 if n is odd, m _{max} = (n + 1)/2
Q _m	= Q of mth pair of tuned circuits

and n, the program will determine each tuned-circuit Q, (f_a)_m and (f_b)_m, the bandwidth at any arbitrary frequency (in this case, the -60-dB points), and the attenuation at any frequency off resonance (in this case, 20 kHz away).

Sample computation

After entering the Butterworth program, key in 455 and depress A to enter the resonant frequency. Then pressing 10, ENTER, 3, B, enters the 10-kHz bandwidth at the -3-dB points. The 30-kHz bandwidth at -30 dB is entered by keying in 30, ENTER, 30, C.

Pressing D indicates the calculation for determining the number of tuned circuits needed. In this case, a value of n=4 is displayed. Pressing E yields an m_{max}=2, indicating that there are two pairs of frequencies in our staggered-tuning scheme.

To compute the staggered tuned frequencies, press f, A. The number 456.91 will appear, which indicates that (f_a)₂=456.91 kHz. Pressing f, B, reveals that (f_b)₂=453.09 kHz. Pressing f, A, a second time yields (f_a)₁=459.62 kHz; and f, B, that (f_b)₁=450.38 kHz. Since n_{max}=2, pressing f, A, a third time should display 0.00, which indicates that all computations are complete.

In cases where there are an odd number of tuned circuits, the first f_a and f_b are the same and will be equal to center frequency f_o.

The next step determines the Q of each circuit. Pressing f, C, shows that Q₂ = Q_{max} = 49.22. This is the Q required for the (f_a)₂-(f_b)₂ pair. Pressing f, C, a second time shows that Q₁ = Q_{max} = 118.83, the Q required for the (f_a)₁-(f_b)₁ pair. Another depression, of course, produces 0.00.

Entering 60 on the keyboard and pressing f, E, reveals

that the bandwidth at the -60-dB points is 56.27 kHz. Entering 40 (that is, 2 × 20 kHz), f, D, reveals that there is a 48.14-dB attenuation 20 kHz off resonance.

This procedure may be carried on for as many bandwidths or attenuations as desired. Thus a plot of attenuation versus frequency is possible. Figure 1d shows the completed design.

The Chebyshev response

The Butterworth response results from a superposition of several single tuned responses. It is apparent that a wider passband can be attained with a minimum number of tuned circuits if the resonant frequencies are spread a bit further apart and if the peaks and valleys thus produced in the passband are ignored. The mathematician's description of this response—characterized as equiripple in the passband and monotonic in the stop band—involves the use of a series of numbers that is called a Chebyshev polynomial.

Manual calculation of the equations used to design a circuit having the Chebyshev response, which is shown in Fig. 2a, is a nuisance because of the need to handle hyperbolic sines and cosines. With the HP-67/97, however, these equations are only slightly more troublesome to calculate than the Butterworth equations.

One difference in the characterization of the Chebyshev response can be noted from Fig. 2a—the reference bandwidth, BW_i, is taken at the amplitude points that match the valleys in the equiripple response, rather than at the -3-dB or -6-dB points customary with the synchronous and Butterworth responses.

The formulas

Following the same series of steps used in the Butterworth case yields the number of tuned circuits required for a given Chebyshev response:

$$n = \cosh^{-1} \left[\frac{(V/V_i) - 1}{(V/V_i)^2 - 1} \right] \div \cosh^{-1} \frac{BW_j}{BW_i} \quad (9)$$

The staggered tuned frequencies are calculated from:

$$(f_a)_m = 0.5 BW_i C_n \cos \left(\frac{2m-1}{n} 90^\circ \right) + f_o \quad (10)$$

where:

$$C_n = \cosh \left\{ n^{-1} \sinh^{-1} \frac{1}{[(V/V_i)^2 - 1]^{1/2}} \right\} \quad (11)$$

$$(f_b)_m = 2f_o - (f_a)_m$$

The Qs of the respective tuned circuits are determined from:

$$Q_m^{-1} = \frac{BW_i}{f_o} S_n \sin \left(\frac{2m-1}{n} 90^\circ \right) \quad (12)$$

where:

$$S_n = \sinh \left\{ n^{-1} \sinh^{-1} \frac{1}{[(V/V_i)^2 - 1]^{1/2}} \right\} \quad (13)$$

The skirt selectivity is found from:

$$\frac{V}{V_x} = \left\{ 1 + \left[\left(\frac{V}{V_i} \right)^2 - 1 \right] \left[\cosh^2 \left(n \cosh^{-1} \frac{BW_x}{BW_i} \right) \right] \right\}^{1/2} \quad (14)$$

TABLE 2: HP-97 PRINTER LISTING FOR BUTTERWORTH PROGRAM

001	*LBLA	059	GTO1	117	X
002	STO1	060	*LBL2	118	1
003	RTN	061	RCL2	119	-
004	*LBLB	062	STO8	120	RCL6
005	2	063	*LBL0	121	÷
006	0	064	R/S	122	9
007	÷	065	GTO0	123	0
008	10 ^X	066	*LBLa	124	X
009	STO2	067	*LBL4	125	SIN
010	R ↓	068	RCL3	126	RCL5
011	STO3	069	2	127	2
012	RTN	070	÷	128	X
013	*LBLC	071	RCL7	129	RCL1
014	2	072	RCL6	130	÷
015	0	073	2	131	X
016	÷	074	X	132	1/X
017	10 ^X	075	1/X	133	R/S
018	STO4	076	Y ^X	134	*LBLc
019	R ↓	077	÷	135	DSZi
020	STO5	078	STO5	136	GTO5
021	RTN	079	RCL8	137	0
022	*LBLD	080	2	138	R/S
023	RCL4	081	X	139	*LBLd
024	X ²	082	1	140	RCL3
025	1	083	-	141	÷
026	-	084	RCL6	142	RCL6
027	RCL2	085	÷	143	2
028	X ²	086	9	144	X
029	1	087	0	145	Y ^X
030	-	088	X	146	RCL7
031	STO7	089	STO4	147	X
032	÷	090	COS	148	1
033	LOG	091	X	149	+
034	RCL5	092	RCL1	150	√X
035	RCL3	093	+	151	LOG
036	÷	094	DSP2	152	2
037	LOG	095	R/S	153	0
038	2	096	*LBLb	154	X
039	X	097	RCL1	155	R/S
040	÷	098	2	156	*LBLe
041	INT	099	X	157	2
042	1	100	-	158	0
043	+	101	CHS	159	÷
044	STO6	102	R/S	160	10 ^X
045	DSPO	103	*LBLa	161	X ²
046	R/S	104	8	162	1
047	*LBL E	105	STO1	163	-
048	*LBL1	106	DSZi	164	RCL7
049	2	107	GTO4	165	÷
050	÷	108	*LBL9	166	RCL6
051	STO2	109	0	167	2
052	FRC	110	R/S	168	X
053	0	111	*LBLc	169	1/X
054	X=Y?	112	RCL2	170	Y ^X
055	GTO2	113	STO8	171	RCL3
056	RCL6	114	*LBL5	172	X
057	1	115	RCL8	173	R/S
058	+	116	2		

INSTRUCTIONS

- Key in program
- Enter design parameters: center frequency, reference bandwidth, reference attenuation, skirt bandwidth, skirt attenuation (f_o), A, (BW_i), ENTER, (A_j), B, (BW_j), ENTER, (A_j), C
- Press D to find the number of tuned circuits required (n)
- Press E to find the number of frequency pairs (m)
- Press f, A, to calculate the first high-side frequency (f_a)
- Press f, B, to calculate the first low-side frequency (f_b)
- Repeat the preceding two steps sequentially for a complete tabulation of high-side and low-side frequency pairs
When 0.00 is displayed, the list is complete
- Press f, C, to find Q of first frequency pair (Q)
Repeat above step to find Qs of the remaining m pairs of tuned circuits, which appear in the same order as the high-side and low-side frequency pairs.
When 0.00 is displayed, the list is complete.
- Enter arbitrary bandwidth and read attenuation at that bandwidth, or enter arbitrary attenuation and read bandwidth at that attenuation level (BW_x), f, D -----> A_x displayed in dB
or (A_x), f, E -----> BW_x displayed
- Repeat the preceding step as necessary to generate response plot.
- Units of f and BW are arbitrary, but must be consistent throughout run

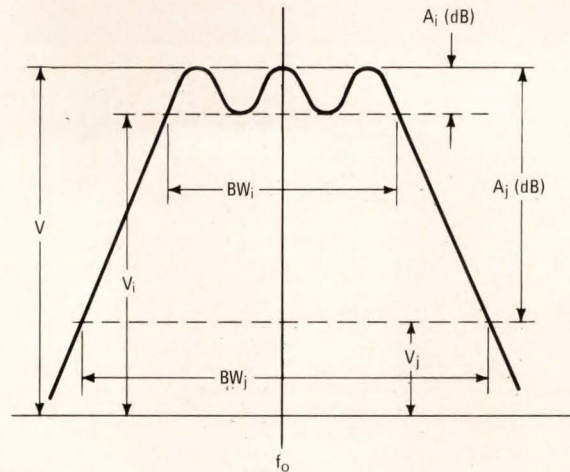

(a)

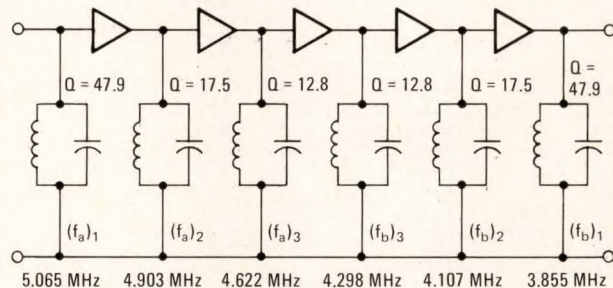

(b)

$f_o = 4.46$ MHz
BANDWIDTH = 1.2 MHz
PASSBAND RIPPLE = 0.5 dB
60-dB ATTENUATION 1 MHz
BEYOND EITHER BANDEGE

2. Chebyshev response. Broader response (a) is attained by cascading n tuned circuits whose individual resonant frequencies are further apart than those in the Butterworth case. Completed design of wide-band amplifier discussed in the text is shown (b). Note symmetrical distribution of Qs and f_a and f_b on each side of f_o .

$$BW_x = BW_i \cosh \left\{ \frac{1}{n} \cosh^{-1} \left[\frac{(V/V_x)^2 - 1}{(V/V_i)^2 - 1} \right]^{1/2} \right\} \quad (15)$$

Eqs. 9 through 15 form the nucleus of a pair of programs known as the Chebyshev and Chebyshev plotter routines, shown in Tables 3 and 4, respectively. Using the equations in the order given enables intermediate values to be stored in memory and allows these values to be carried from the Chebyshev to the Chebyshev plotter program, which is used to plot a frequency-versus-attenuation response. A simple example follows.

Sample computation

Assume an i-f amplifier must have a flat response within 0.5 dB between 3.9 and 5.1 megahertz and must attenuate interfering signals 1 MHz beyond either band edge by 60 dB. As a first step, the center frequency, and the reference bandwidths and attenuations must be

TABLE 3: HP-97 PRINTER LISTING FOR CHEBYSHEV PROGRAM

001	*LBLA	046	\sqrt{X}	091	+	136	DSZi
002	STO1	047	+	092	LN	137	GTO4
003	RTN	048	LN	093	RCL6	138	RCL5
004	*LBLB	049	$X \leftrightarrow Y$	094	1/X	139	e^X
005	2	050	÷	095	X	140	ENT†
006	0	051	STO6	096	STO5	141	1/X
007	÷	052	0	097	e^X	142	-
008	10^X	053	RTN	098	ENT†	143	2
009	STO2	054	*LBLD	099	1/X	144	÷
010	R†	055	RCL6	100	+	145	STO5
011	STO3	056	INT	101	2	146	0
012	RTN	057	1	102	÷	147	R/S
013	*LBLC	058	+	103	STO4	148	*LBLc
014	2	059	STO6	104	*LBL4	149	RCL3
015	0	060	DSP0	105	RCL3	150	RCL1
016	÷	061	R/S	106	2	151	÷
017	10^X	062	*LBL E	107	÷	152	RCL5
018	STO4	063	2	108	RCL4	153	X
019	R†	064	÷	109	X	154	STO4
020	STO5	065	STO7	110	RCL8	155	RCL7
021	RCL3	066	FRC	111	2	156	STO8
022	÷	067	0	112	X	157	*LBL5
023	ENT†	068	$X=Y?$	113	1	158	RCL8
024	X^2	069	GTO2	114	-	159	2
025	1	070	RCL6	115	RCL6	160	X
026	-	071	1	116	÷	161	1
027	\sqrt{X}	072	+	117	9	162	-
028	+	073	GTOE	118	0	163	RCL6
029	LN	074	*LBL2	119	X	164	÷
030	RCL4	075	RCL7	120	COS	165	9
031	ENT†	076	STO8	121	X	166	0
032	X	077	R/S	122	RCL1	167	X
033	1	078	*LBLa	123	+	168	SIN
034	-	079	RCL2	124	DSP3	169	RCL4
035	RCL2	080	ENT†	125	R/S	170	X
036	ENT†	081	X	126	*LBLb	171	1/X
037	X	082	1	127	RCL1	172	DSP1
038	1	083	-	128	2	173	R/S
039	-	084	\sqrt{X}	129	X	174	*LBLc
040	÷	085	1/X	130	-	175	DSZi
041	\sqrt{X}	086	ENT†	131	CHS	176	GTO5
042	ENT†	087	X^2	132	R/S	177	0
043	X^2	088	1	133	*LBLa	178	R/S
044	1	089	+	134	8		
045	-	090	\sqrt{X}	135	STOI		

INSTRUCTIONS

- Key in program
- Enter design parameters: center frequency, reference bandwidth, reference attenuation, skirt bandwidth, skirt attenuation
(f_0), A, (BW_i), ENTER, (A_i), B, (BW_j), ENTER, (A_j), C
- Press D to find the number of tuned circuits required (n)
- Press E to find the number of frequency pairs (m)
- Press f, A, to calculate the first high-side frequency (f_a)
- Press f, B, to calculate the first low-side frequency (f_b)
- Repeat the preceding two steps sequentially for a complete tabulation of high-side and low-side frequency pairs
When 0.00 is displayed, the list is complete
- Press f, C, to find Q of first frequency pair (Q)
Repeat the preceding step to find Qs of the remaining m pairs of tuned circuits, which appear in the same order as the high-side and low-side frequency pairs. When 0.00 is displayed, the list is complete
- Units of f and BW are arbitrary, but must be consistent throughout run

determined. Thus:

$$f_0 = (3.9 \times 5.1)^{1/2} = 4.46 \text{ MHz}$$

$$BW_i = 1.20 \text{ MHz}$$

$$A_i = 0.5 \text{ dB}$$

$$BW_j = 1.20 + 2 = 3.20 \text{ MHz}$$

TABLE 4: HP-97 PRINTER LISTING FOR CHEBYSHEV PLOTTER PROGRAM

001	*LBLA	033	X^2
002	RCL3	034	1
003	÷	035	-
004	GSBD	036	÷
005	RCL6	037	\sqrt{X}
006	X	038	GSBD
007	GSBE	039	RCL6
008	X^2	040	÷
009	RCL2	041	GSBE
010	X^2	042	RCL3
011	1	043	X
012	-	044	DSP2
013	X	045	R/S
014	1	046	*LBLD
015	+	047	ENT†
016	\sqrt{X}	048	X^2
017	LOG	049	1
018	2	050	-
019	0	051	\sqrt{X}
020	X	052	+
021	FIX	053	LN
022	DSP2	054	RTN
023	R/S	055	*LBL E
024	*LBLB	056	e^X
025	2	057	ENT†
026	0	058	1/X
027	÷	059	+
028	10^X	060	2
029	X^2	061	÷
030	1	062	RTN
031	-	063	R/S
032	RCL2		

INSTRUCTIONS

- Key in program
- Enter arbitrary bandwidth and read attenuation at that bandwidth, or enter arbitrary attenuation and read bandwidth at that attenuation level
(BW_x), A ----- \rightarrow A_x displayed in dB
or (A_x), B ----- \rightarrow BW_x displayed
- Repeat the preceding step as necessary to generate response plot
- This program must be preceded by the Chebyshev program. Units of frequency will be consistent with those of the Chebyshev program.

$A_j = 60 \text{ dB}$

After entering the Chebyshev program, key in the center frequency (f_0) by pressing 4.46, A. The reference bandwidth (BW_i) and attenuation (A_i) are entered by keying in 1.20, ENTER, 05, B, while the adjacent channel selectivity, BW_j , and attenuation A_j are entered with 3.2, ENTER, 60, C. Pressing D at this point yields $n=6$, and pressing E yields $m=3$, the number of staggered tuned pairs.

Pressing f, A and f, B sequentially determines (f_a)_n and (f_b)_n. The results are:

$$(f_a)_3 = 4.622 \quad (f_b)_3 = 4.298$$

$$(f_a)_2 = 4.903 \quad (f_b)_2 = 4.017$$

$$(f_a)_1 = 5.065 \quad (f_b)_1 = 3.855$$

$$(f_a)_0 = 0.00$$

If f, C, is now pressed, it is found that $Q_3=12.8$. Successive pressing of f, C, yields: $Q_2=17.5$, $Q_1=47.9$, and $Q_0=0$.

Finally, by entering the Chebyshev plotter program, the out-of-band response of the i-f amplifier can be found. If 40, B, is keyed in, the program determines that the passband is 1.94 MHz wide at the -40-dB point. If, on the other hand, the attenuation at the 2.5-MHz bandwidth is desired (1.25 MHz from f_0), key in 2.5, A. The program determines the attenuation at that bandwidth to be 55.92 dB. The completed design is in Fig. 2b. □

IEDM heralds breakthroughs in LSI fabrication, power discretes

Mixed digital-and-linear processes also shine at International Electron Devices Meeting notable for heavy Japanese participation

by Lawrence Altman, *Solid State Editor*,
and Lucinda Mattera, *Components Editor*



Japan's outlook. Yasuo Tarui, head of Japan's VLSI program, says that n-channel MOS techniques will provide the main thrust for digital design in the next few years. He foresees electron-beam fabrication on wafers picking up where the optical approach leaves off.

□ To the semiconductor specialists gathering at this week's International Electron Devices Meeting in Washington, D. C., the main focus of interest is finer microcircuit pattern geometry, with smaller, more powerful discrete devices running a close second.

If device pattern techniques have always been prominent on IEDM agendas, this year the subject has new urgency, as designers push device technology to new levels of performance and packing density. In power devices, also, there are four major breakthroughs.

In these areas and others, IEDM underlines yet another development: the full flowering of Japanese device and circuit technology. Josef Berger, this year's IEDM general chairman, and Alfred MacRae, technical program chairman, have wisely included some 30 Japanese papers in the three-day conference, a block that makes up about 20% of the total. This work is of extremely high quality, especially in device processing and fabrication, and can only strengthen the growing realization that Japanese technologists rank among the world's best.

Indeed, there is no better evidence of Japan's rising expertise in semiconductors than the General Session's invited paper by Yasuo Tarui, a leading technologist and director of the cooperative VLSI laboratory sponsored by the Japanese government. Staffed from among Japan's most qualified scientists and engineers, the VLSI lab has been charged with the responsibility for developing the basic semiconductor technology and circuit tools needed for very-large-scale integrated circuitry and next-generation computers (see "The gathering wave of Japanese technology," *Electronics*, June 9, p. 99).

As described by Tarui, Japan's technology efforts "involve the interrelationship of all semiconductor disciplines: process microfabrication, crystal technology, and semiconductor design, test, and evaluation." While Tarui claims that Japanese technologists are in command of all the major VLSI technologies (short-channel metal-oxide-semiconductor, double-diffused MOS, silicon-on-sapphire techniques; injection, current-mode, and emitter-coupled logic; charge-coupled devices and bubble memories), he sees short-channel or D-MOS as offering the best promise for VLSI implementation, at least for the next few years.

The 2-micrometer-wide channel

Tarui and his Japanese cohorts are also strong on the importance of the electron beam for device patterning: first it will be used for building masks, then for fabricating microcircuits directly onto wafers. "With electron-beam masks, and photo-optical projection printing," says Tarui, "we can now make 2- μ m-channel MOS devices for 65,536-bit dynamic RAMs and 16-bit microcomputers. In two years, with electron-beam fabrication directly onto wafers, we'll make 1-to-2- μ m devices for 256-kilobit RAMs and 32-bit microcomputers." To this end, his laboratory is experimenting with a wide range of in-house and commercial electron-beam equipment.

While the Japanese race toward 100,000-to-200,000-device chips, major American IC makers are not idling on their own VLSI projects. Indeed, the world's two largest manufacturers of ICs, IBM Corp. and Texas Instruments Inc., are giving IEDM attendees a glimpse of

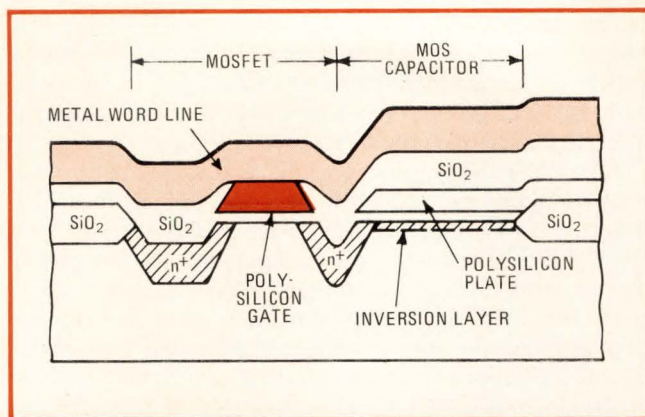

1. New memory. This IBM structure, called the plate-gate cell, results in the smallest yet dynamic RAM cells because it eliminates the bulky contacts between gate and storage capacitance. The cell is less than a third of a square millimeter in area.

the cutting edge of their technology for producing next-generation random-access memories. Both use advanced MOS circuit and fabricating techniques for shrinking basic dynamic-RAM cell structures to an area as small as the intersection of two electrodes.

The IBM approach combines a single-level cell with a self-registering metal-to-polysilicon contact scheme to achieve a density the same as or higher than that attained by the most advanced double-metal technique now in use on 16-k RAMs. Moreover, the design requires one mask step fewer and has higher yields.

The structure is called the gate-plate memory cell (Fig. 1) by IBM's J. Watson Research Center workers V. Leo Rideout, John J. Walker, and Alice Cramer, because the gate, with its self-registering contact, is delineated before the plate that serves as the cell's insulated storage capacitor. The improved density arises partly from a shorter channel, made possible by the elimination of the bulky alignment contacts between the gate and storage capacitor that encumber conventional RAM cells. In addition, by virtue of improved isolation of circuit elements, narrow spacing between the gate and the capacitor storage plate is possible both laterally and vertically. It all adds up to a cell area of 0.3 mil² using standard photolithography, or a half to a third the area of today's 16-k double-level structures.

A bigger charge for CCD RAMs

TI's approach to high-density RAMs is an improvement over a structure first made public at the device meeting two years ago [*Electronics*, Dec. 25, 1975, p. 30]. It uses the same charge-coupled RAM cell in combination with a one-transistor memory structure, but removes a major limitation of the charge-coupled cell by boosting the charge capacity and with it the cell's output signals. Dubbed the Hi-C RAM cell by its inventors, Al Tasch, P. K. Chatterjee, H. S. Fu, and Tom Holloway, the modified cell has a charge storage capacity that is 50% to 100% greater than that of conventional single-transistor cells. Moreover, Hi-C test cells already fabricated in TI's central research laboratory exhibit a third the charge leakage of earlier charge-coupled cells.

The boosting technique can be applied to either single-

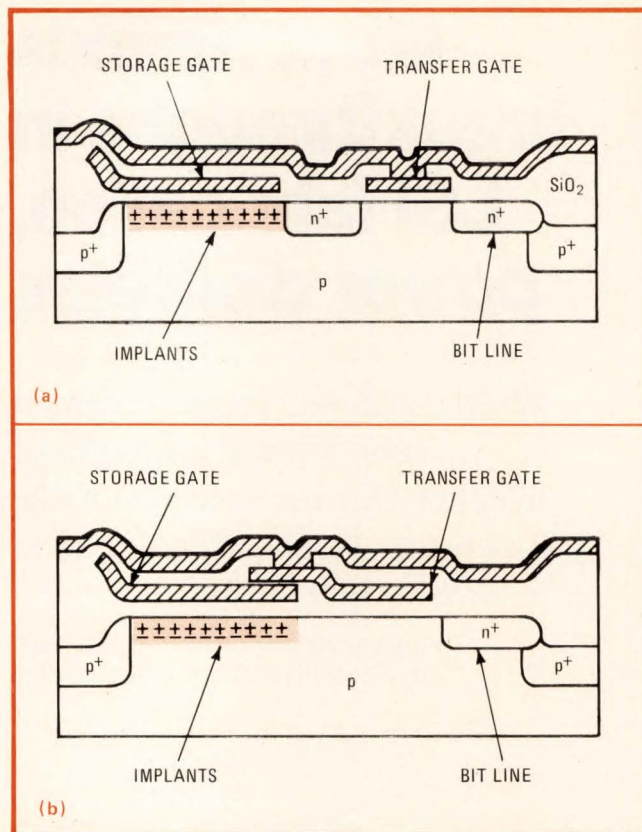

2. Hi-C cell. Texas Instruments' new charge-coupled cell produces larger output signals because of a storage capacity that is one and a half to two times greater than its predecessors. It also has less charge leakage than older CCD types.

or double-level cells and involves adding a shallow n-type implant at or very near the silicon-oxide-silicon substrate interface (tinted in Fig. 2). This implant prevents the potential difference on the surface from decreasing during charge transfer, producing a significant increase in charge capacity per unit area.

Buried-oxide MOS rivals SOS

It is also in the digital area that the best Japanese work is being reported. For example, J. Sakurai and other workers at Fujitsu Ltd.'s Computer Development Laboratory have developed a new MOS isolation technique, called buried-oxide or BO-MOS, which isolates not only the side walls of the MOS structures, as in today's oxide-isolated n-MOS processes, but also the substrate interface under the source and drain diffusions, as in proposed silicon-on-sapphire circuits. The result is a fast, dense, high-yield standard bulk n-MOS technology that has high carrier mobility and low-leakage junctions but does not suffer the SOS drawbacks of an expensive substrate and a high defect density on the epitaxial silicon surface.

In the BO-MOS process, a thick field-oxide layer extends beneath the source and drain regions, isolating the diffusions beneath as well as around their sides. In the enveloping process, the crucial fabrication step is the simultaneous deposition of polysilicon and single-layer silicon over the selectively oxidized silicon wafer, a tricky procedure that Fujitsu technologists solved by improving

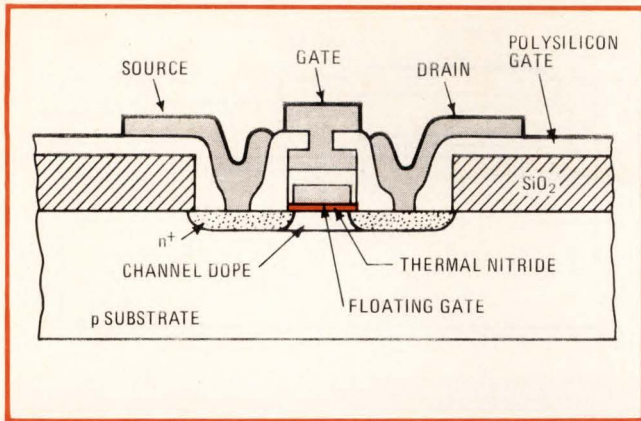

3. Better floating gates. Fujitsu's Famos erasable-read-only-memory cell has a low 10-volt writing and reading voltage, thanks to the presence of a thin layer of silicon nitride under the floating-gate electrode. Nevertheless, the ROM can retain charge for years.

high-temperature polysilicon deposition techniques.

To test the process, Fujitsu engineers used BO-MOS to redesign two existing Fujitsu 1,024-bit high-speed n-MOS RAMS (MBM2115/2125) and a complementary-MOS shift register (MB84021). Using 4- μ m BO-MOS structures, the new designs are at least twice as fast as the equivalent n-MOS and C-MOS designs (access time for the BO-MOS 2115 is under 50 nanoseconds).

Just as much of a pacesetter is Fujitsu's work on alterable read-only memories. Researchers at the firm's central laboratories, among them M. Shinoda, have taken the conventional Famos process, used to build some types of electrically alterable ROMs, and modified it so that writing and erasing voltages are lowered significantly. At write/read voltages of 10 volts (they are 25 to 30 v for conventional parts), the Fujitsu process could increase the utility of these ROMs for microcomputer prototype applications, eliminating the need for high-voltage programmable-ROM writers and erasers.

The basic structure (Fig. 3) is a conventionally stacked gate, consisting of a double polysilicon layer. But the floating gate is isolated from the silicon substrate by a thin, 95-angstrom-thick layer of silicon nitride, instead of the rather thick layer of silicon dioxide used in the old Famos process. It is the better isolation characteristic of silicon nitride that permits this layer to be so thin and the cell to be written and erased with low voltages.

Mixing it up

While digital techniques dominate the IEDM program, important work is also being disclosed in mixing linear and digital devices together on the same LSI chip. A most interesting development comes from the University of Dortmund in West Germany, where B. Hoefflinger, J. Schneider, and G. Zimmer have developed a process that permits high-performance n-MOS and C-MOS digital devices to sit on the same chip as n-MOS, C-MOS, and npn bipolar linear devices. Such linear devices as operational amplifiers, data converters, and high-current drivers can now more freely be inserted into large digital chips like memories or microprocessors.

The Dortmund technique makes creative use of boron as a key dopant throughout the chip, not simply in the

digital bipolar device bases to improve their conduction. Now boron is implanted throughout the field oxide, setting the field and enhancement thresholds of the digital device simultaneously and making them compatible with the analog C-MOS and npn bipolar devices.

Early tryouts of the technique look good. For example, on a 20-square-millimeter test chip, researchers have put n-MOS enhancement-depletion ring oscillator devices, C-MOS ring oscillators, C-MOS inverters, n-MOS bucket brigade devices, n-MOS and C-MOS op amps, and MOS-bipolar npn output stages: in short, everything needed for building complex data-processing, signal-conducting, and data-reduction systems.

Conversely, to put digital circuitry on a basically analog chip, K. Murakami and other engineers at Japan's Mitsubishi Electric Corp. are employing double-diffusion technology to combine bipolar transistors and MOS field-effect transistors on the same piece of silicon. Depositing the dopants via a double ion implantation gives tight control over the threshold voltage of the MOSFETs, as well as extracting high current gain from the npn devices, the developers say. The integrated circuit (Fig. 4) that results, they explain, provides the high transconductance and high input impedance of MOSFET circuitry, plus the large current-driving capability of bipolar circuitry.

Using the new mixed process, the group has built a wide-band multivibrator with a variable output frequency that may be controlled with extreme precision. Even for outputs down below 0.01 hertz, frequency error is held to within 0.4%, control said to be more than an order of magnitude better than that usually provided by an all-bipolar design. The developers expect applications of their bi-MOS technology to include timers, operational amplifiers, and comparators.

Semiconductor power

Unquestionably, breakthroughs in power semiconductors are the biggest component news at this year's meeting. At least four separate developments mark the milestones: the first complementary pair of power MOSFETs, a gate-turnoff silicon controlled rectifier that rivals the switching speed of bipolar transistors, a light-triggered high-power SCR offering amplified-gate operation yet little or no degradation of switching characteristics, and a workhorse of a high-power SCR rated at 4,000 volts and 800 amperes for the transmission of dc power.

Power MOSFETs are getting a lot of attention these days—and they deserve to. Their advantages over bipolar transistors include: higher input impedance, unlimited range of voltage standing-wave ratios in radio-frequency applications, freedom from thermal runaway and secondary breakdown, and most importantly, higher switching speeds and cutoff frequencies. To date, though, available power MOSFETs have been only p-channel devices, whereas the complementary operation of a p- and n-channel pair would be much more efficient.

The problem has been the destructive breakdown of n-channel devices at drain voltages above 100 v. But T. Okabe and other experimenters at Hitachi's Central Research Laboratory in Japan have found a solution that has enabled them to build a complementary pair of

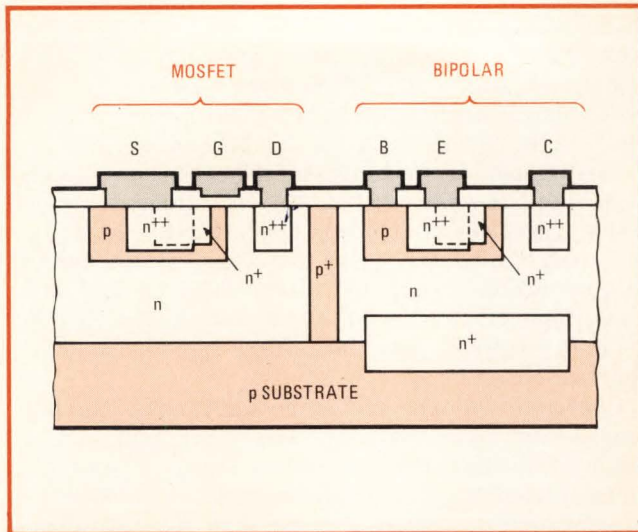

4. Mixed process. Employing a double ion implantation, Mitsubishi is putting MOSFETs and npn bipolar transistors on the same chip. Applications for the new process include such traditional linear devices as timers, operational amplifiers, and comparators.

power MOSFETs suitable for use in high-fidelity audio amplifiers. Each device has a drain breakdown voltage as high as 200 v and can handle currents up to 10 A, as a result of being built with an offset gate and an additional ion-implanted channel as well as a field plate (Fig. 5a). Both MOSFETs have the same characteristics, although the p-channel device needs a 5-by-5-mm chip and the n-channel device only a 4.5-by-4.5-mm chip, a difference due largely to their differing carrier mobilities.

Figure 5b shows the total harmonic distortion of a 100-watt audio amplifier built with the new complementary MOSFETs, compared with the distortion for one built with bipolar transistors. Clearly, the MOSFET amplifier is capable of delivering continuous output power of 100 w to an 8-ohm load with less than 0.01% total harmonic distortion. But in this power and frequency range, the conventional amplifier slips into thermal runaway.

A fast gate-turnoff SCR

Just as the name implies, a gate-turnoff SCR stops conducting upon application of a reverse-bias voltage to its gate terminal. When the device is on, it conducts uniformly over its entire cathode area. However, when a negative bias is applied to the gate, the conducting electron-hole plasma is squeezed, forming a high-current-density filament. If the reverse applied voltage is not large enough to bring about speedy and complete turnoff, local overheating may cause failure much like the secondary breakdown of bipolar transistors.

As a solution to these turn-off problems, Hans W. Becke, who is with the Advanced Power Laboratory of RCA Corp.'s Solid State division, Somerville, N. J., places a small inductance—on the order of microhenries—in series with the gate. Besides making turnoff much safer, the new structure exhibits shorter storage and fall times than earlier devices. From one of his experimental 8-A, 600-v SCRs, Becke has obtained a rise time of 400 ns and a fall time of only 140 ns. These speeds make it one of the first high-voltage, high-speed

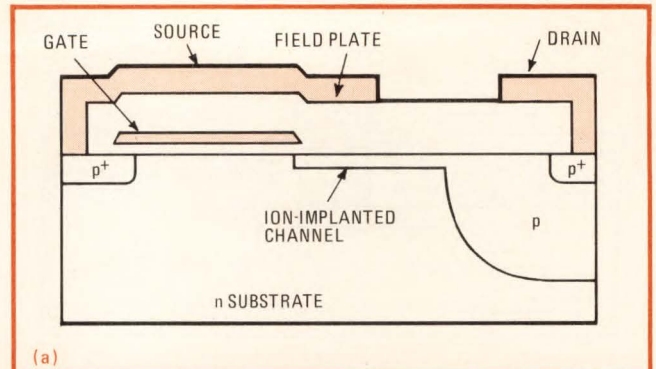

(a)

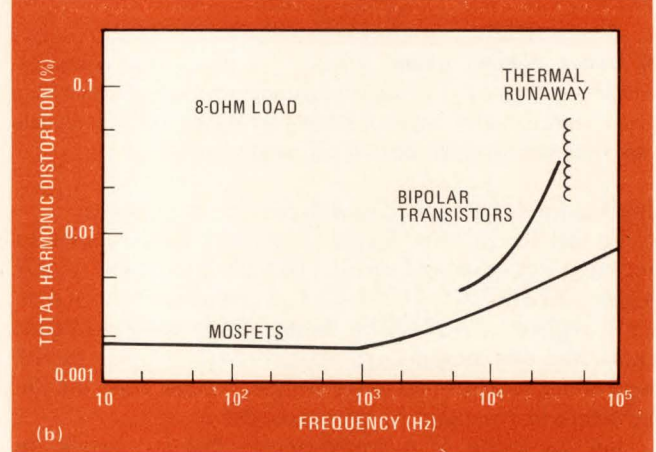

(b)

5. Power duo. With special structure (a) for power MOSFETs that includes an offset gate, Hitachi is able to build a complementary pair of p- and n-channel devices, each rated at 200 V and 10 A. Audio amplifier using them delivers 100 W with only 0.01% distortion (b).

gate-turnoff SCRs to offer switching characteristics on a par with those of high-speed bipolar transistors.

In high-power applications, light-fired SCRs are sometimes used for the sake of their gate isolation. Victor Temple of General Electric Co.'s Corporate Research and Development Center in Schenectady, N. Y., has come up with a new gate design for a light-triggered 1,200-v, 100-A SCR intended for high-voltage inverters. Although its gate sensitivity is 50 times higher than that of earlier devices, the new SCR shows no loss in its dv/dt (turn-off) capability and only a small reduction in its di/dt (turn-on) capability. Key to the design is a second amplifying stage within the gate region, which drops gate threshold currents down to 2 milliamperes, yet keeps dv/dt ratings up as high as 1,000 v per microsecond. At 60 Hz, the device exhibits a di/dt capability of about 250 A/ μ s and turn-off times of about 25 μ s.

Meanwhile, K. Morita and other experimenters at Japan's Hitachi Works and Hitachi Research Labs have developed a large-area high-power SCR for building the converters needed in high-voltage dc transmission systems. In such systems, the fewer the SCRs, the better, so as to minimize the cost of the converter. But the fewer SCRs used, the greater the current each must carry.

To that end, the Hitachi workers have fabricated a single SCR capable of handling 1,500 A and 4,000 v. To build it, they increased the effective conducting area on the wafer to up to 80%, employing gamma-ray irradiation to get precise control over reverse recovery charge. □

Dim light is no turnoff for fluorescence-activated LCD

Constructed so that it concentrates its fluorescence, new type of liquid-crystal display retains low power consumption and is visible at low light levels

by Martin Bechtler and Hans Krüger, *Siemens AG Components Group, Munich, West Germany*

□ In the quest for a digital display that reconciles low power consumption with high visibility under all light conditions, one promising technology is the fluorescence-activated liquid-crystal display. In such units, ambient light stimulates a fluorescent plate constructed so that it concentrates its luminescence on the letter or digit segments of an LCD. The FLAD is visible at low light levels where a standard liquid-crystal display will not be capable of operating.

The choice

Most digital readouts are either active devices such as light-emitting-diode and plasma displays or passive types such as the LCD. Active electro-optical displays emit

optical energy as a function of the electrical energy applied to them. Passive displays simply transmit or reflect ambient light, acting as electro-optical shutters controlled by an applied voltage.

While active devices satisfy most display requirements, passive displays—particularly LCDs—have become increasingly popular. There are two major advantages that LCDs have over active types: they exhibit good contrast over a fairly wide range of ambient brightness, and they operate at microwatt power levels.

As the curves in Fig. 1 show, active displays are already difficult to read at an ambient brightness of about 1,000 lux—a room at normal brightness. In bright daylight, they wash out. Since LCDs are illuminated by

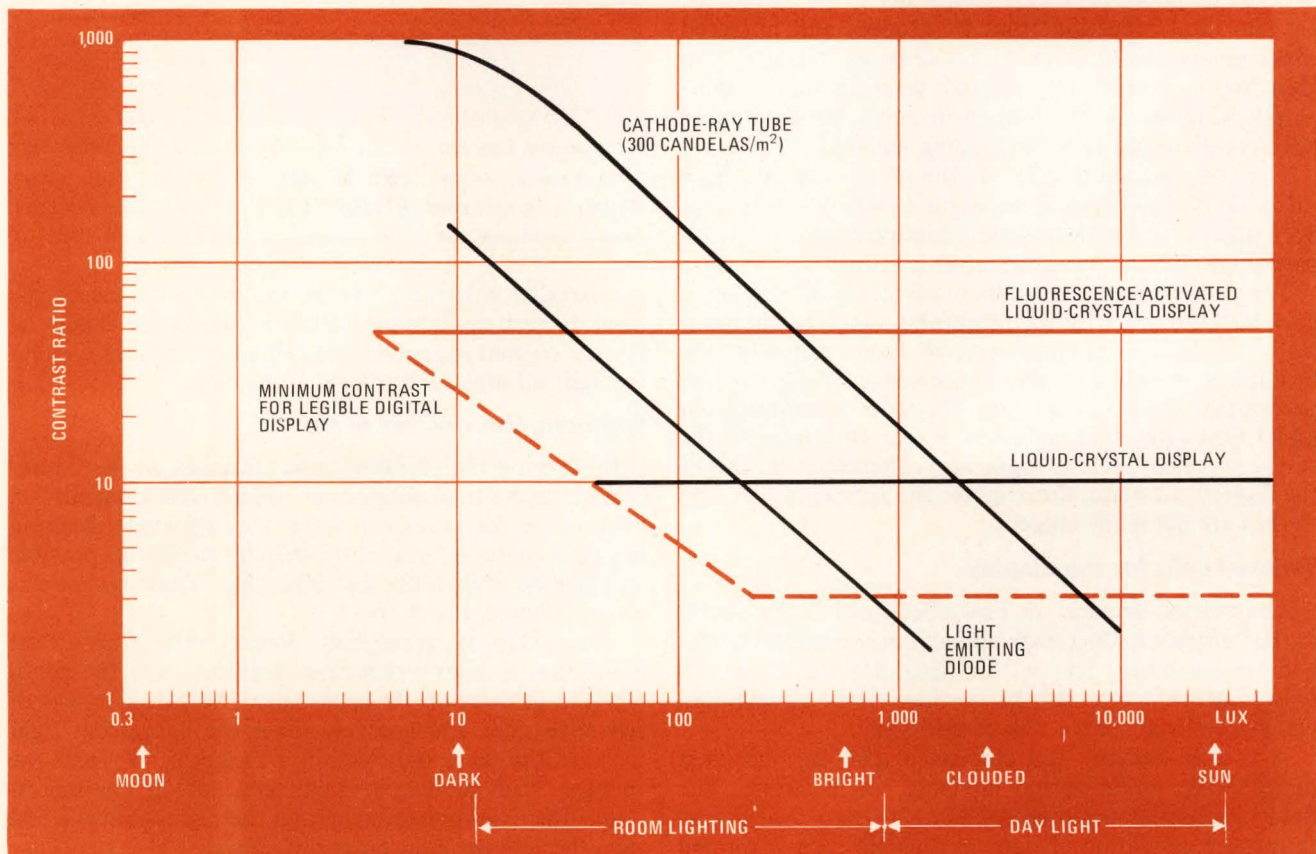

1. Active vs passive. LED displays gradually lose contrast under bright light, while LCDs maintain a flat contrast ratio down to low light conditions. The fluorescence-activated display has a higher contrast ratio than the LCD and operates well from near darkness to bright light.

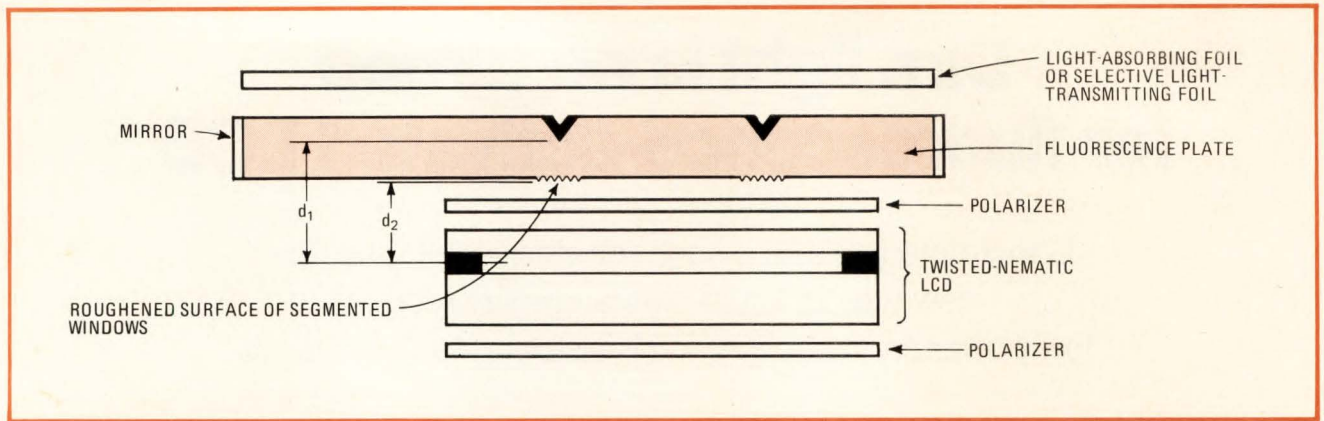

2. Fluorescence-activated. In a FLAD, ambient light hitting a treated plate stimulates fluorescent light, which is radiated throughout the plate. The radiation is directed toward the segmented windows. An LCD directly behind the segments controls light transmission.

the ambient light, their contrast does not drop. However, their weak point is twilight and night conditions when there is insufficient light to activate them, as Fig. 1 illustrates. An external light source can overcome this weakness, but at the penalty of much higher power consumption. A better solution is the FLAD. It can function satisfactorily at a light level of 5 lux because it concentrates its brightness.

How it works

A FLAD's basic elements (Fig. 2) are a liquid-crystal display and a fluorescent plate that absorbs ambient light of a certain wavelength (blue, usually). The plate radiates its fluorescent light uniformly in all directions, but the total reflection from its grooves and mirrored edges guides the light so that it remains mostly in the plate and is emitted only through what are called light-output windows. In the case of displays, these windows have the shape of the corresponding segments.

The LCD, located directly on the plate, acts as a light valve. Only those display segments to which voltage has been applied will transmit the fluorescent light so that a particular alphanumeric character is visible.

The viewer sees the alphanumeric characters on a dark background, with the brightness adapting automatically to the surrounding level of light. Actually, the brightness is equal to the fluorescence efficiency (the percentage of incoming light converted to fluorescent light) times the light-collection factor (the ratio of the surface areas of plate to segments). Therefore, the larger the fluorescent plate, the brighter the segments—so long as they are not made bigger.

Twisted cells for the display

The twisted-nematic, or field-effect, cell is the liquid-crystal display finding wide applications in digital clocks and wristwatches. The cell designed for the FLAD is a twisted-nematic type that has a wider viewing angle than commercially available cells of this type.

A twisted-nematic cell consists of two parallel glass plates with liquid-crystal material in between. The fluid's molecules are oriented in a "twisted" pattern so that the polarization of light passing through is rotated 90°. Applying an electric field to the molecules turns them so that the rotation is cancelled. Because there are

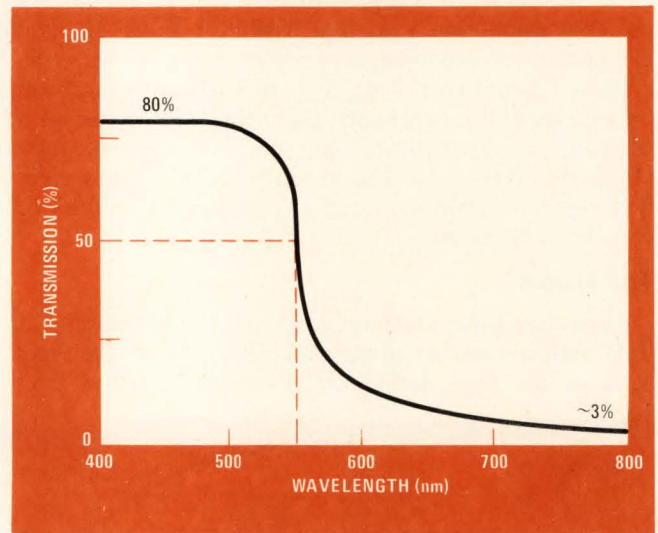

3. Selective. Crossed selective polarizers attenuate fluorescent light while allowing incident light to pass with a slight attenuation. Replacing the conventional polarizers with such filters gives increased display brightness due to the increased incident light available.

two parallel polarizers, one on the back and one on the front, the cell appears dark without excitation. When the electric current is applied, the cell and polarizers then let the light through to the display segments.

Widening the viewing angle

By varying the properties and thickness of the liquid-crystal layer, it is possible to modify the transmission behavior of the LCD for a wider viewing angle. Making the glass plate in back of the display as thin as possible will give an even wider viewing angle. These techniques were applied to the FLAD.

The plate is plexiglass doped with fluorescent molecules. A highly reflective material coats the edges and the grooves on its back side. The arrangement of reflective sides and grooves allows the fluorescent light to leave the plate only within a range of 45° from the vertical. With such an arrangement, 24% of the fluorescence dissipates outward through the plate—but the rest exits through the light-output windows.

The grooves are shaped so as to provide high luminous intensity, little effect of the viewing angle on brightness,

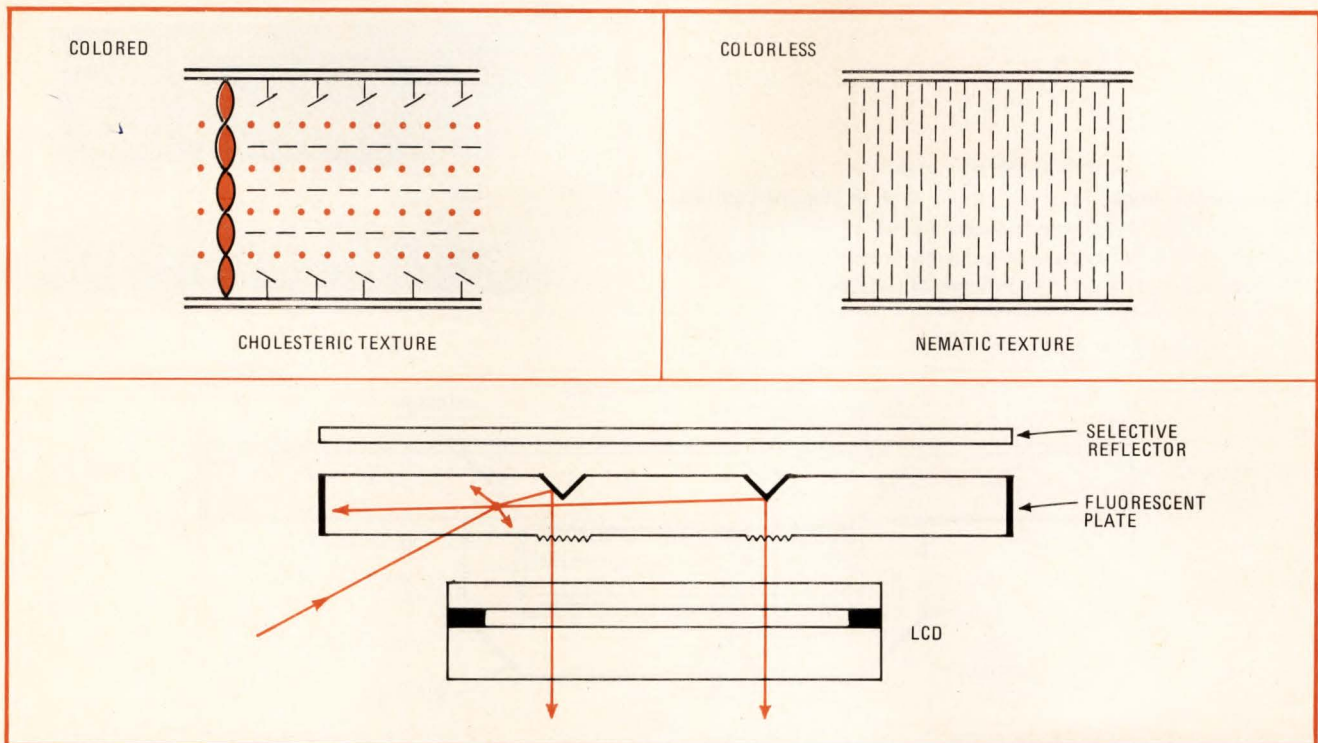

4. Colored LCD. Pleochroic-dye displays (top left) have a twisted-nematic material (top right) that reorients molecules of the dye so that a white numeral is shown on a colored background. With this type of display, the FLAD (bottom) requires no polarizers.

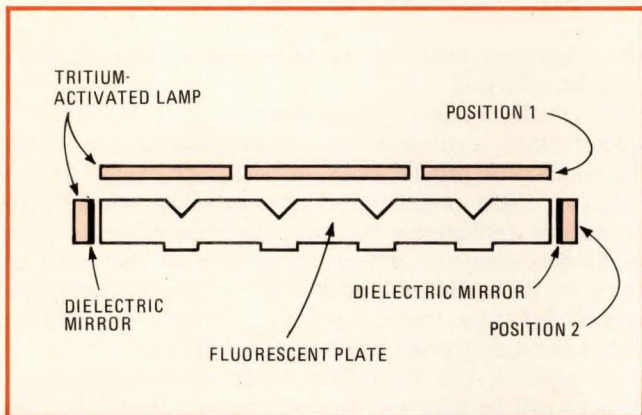

5. Night light. In complete darkness, a tritium-activated light source placed either at position 1 or position 2 will generate sufficient illumination for a FLAD to be easily readable. Dielectric mirrors reflect fluorescent light and transmit the tritium light.

and no shadowing by one segment of another. Brightness at all viewing angles is particularly important, and the reflective coating on the grooves gives a brighter display even at large viewing angles.

Optimization for best results

Another factor affecting the brightness at different viewing angles is the distance between the light source and the LCD layer—the less the distance, the larger the viewing angle. One way to reduce this distance— d_1 in Fig. 2—is to roughen the surface of the light-output window. The fluorescent light then scatters at this surface so that it becomes a virtual light source at distance d_2 from the LCD. Now the plate's thickness does not influence the viewing angle.

The mirrored surfaces and the grooves are arranged so as to provide optimal light transmission, and the roughening of the window surfaces provides optimal wide-angle viewing. A third important determination of quality is fluorescence efficiency, which depends on the emission and absorption characteristics of the fluorescent material embedded in the plastic plate.

The embedded dyes presently available have overlapping emission and absorption bands. Therefore, intensity of the emitted fluorescent light is weakened by self-absorption—although red, orange, and green dyes with very low self-absorption may become available.

Also, the dyes must absorb the ambient light almost completely during a single or double pass through the plate. This calls for a dye with a high concentration—but such a concentration means that self-absorption increases. Therefore, a design objective for the fluorescent plate is the dye that gives high concentration without excessive retention.

Trends in development

If such a dye can be found, it will be possible to fabricate a FLAD with a light-collection area almost equal in size to the glass plate in back of the LCD. As it stands, the fluorescent plate must be considerably bigger than the glass plate in order to provide enough of the necessary radiation.

If a FLAD had such a dye, about 50% of the incident light would reach the fluorescent plate. Half of that—25% of total incident light—would be emitted at an intensification of 150%, assuming a collection factor of 6:1. However, the polarizers' attenuation would cut this figure to 75% of the total ambient light.

Using selective polarizers rather than off-the-shelf

6. Fluorescent clock. Table-top clocks, such as the unit pictured above, have space for a large fluorescent plate with a resulting high brightness. In a FLAD, brightness is directly proportional to the ratio of the fluorescent plate's surface to segment surfaces.

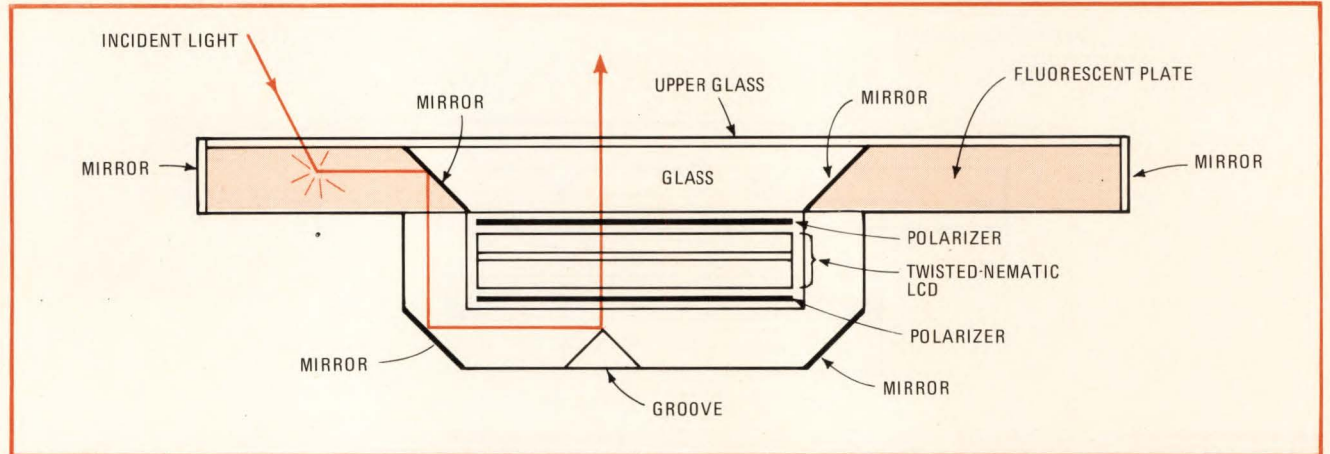
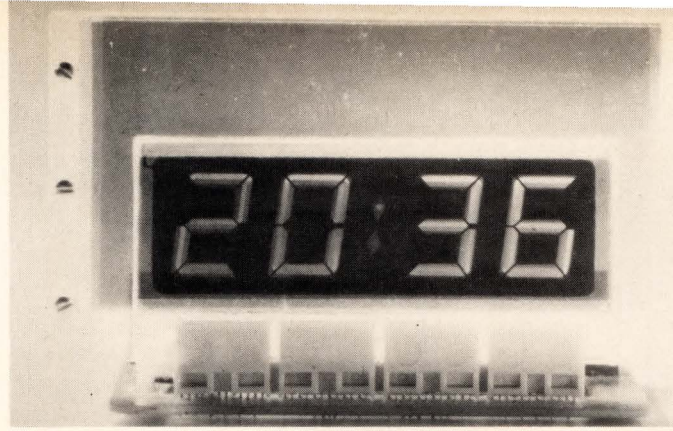

7. Digital watch. A FLAD may be designed to fit into a digital wristwatch's cavity. Incoming light is converted to fluorescent light and guided to the LCD by a series of mirrors and grooves. The grooves direct the intensified light through the LCD's segments.

types can increase the light intensification. Selective types polarize light only of a certain wavelength, letting the other wavelengths pass through to reach the fluorescent plate. Figure 3 shows the transmission behavior of a typical pair of selective polarizers particularly suited for a FLAD. These units transmit 80% of the incident light and 50% of the emitted fluorescent light.

Such selective filters would boost the amount of incident light reaching the plate with the ideal dye to 80%. Assuming the same plate efficiency as before, 40% of this light would be absorbed and emitted at an intensification of 240%. The polarizers' attenuation would cut this to an equivalent of 120% of total ambient light.

Brighter digits with pleochroic dyes

Use of pleochroic dyes as guest materials in liquid-crystal layers can increase the FLAD digits' brightness even more. A pleochroic liquid-crystal mixture transmits colored light when activated and absorbs it when inactive. The crystals' orientation determines transmission and absorption and makes it possible to build an LCD without filters. Thus the attenuation factor affecting the intensification of the fluorescent light is eliminated.

In a pleochroic-dye display, the twisted-nematic material reorients the pleochroic molecules to change absorption characteristics. An applied voltage in the pattern of a numeral or letter causes the dye molecules in that pattern to become colorless, thus forming the display characters. Textures of pleochroic and standard twisted-nematic LCDs are depicted in Fig. 4, as is the structure of a FLAD with a pleochroic dye.

Brightness can be increased further by halving the emitting angle. To maintain an adequate viewing angle,

the roughened areas of the light-transmitting windows must be enlarged.

Of course, a FLAD will not function in total darkness, since it needs a minimal light source. A way out of this dilemma is to provide a tritium-activated light source (Fig. 5). Light is generated in laser-sealed glass tubes containing radioactive tritium. The tritium's beta rays (9 kiloelectronvolts) activate phosphor on the walls of the glass tubes. Because of the light-intensification property of the FLAD, this method is three times more effective than when applied to a conventional LCD.

In general, the fluorescence-activated liquid-crystal display will be used anywhere a passive display can be employed. Moreover, its lower power consumption means it can take over from light-emitting diodes those display jobs with low ambient light levels.

Lighting the way

The first applications for the FLAD will be those in which there is enough room for a large-area fluorescent plate—for instance, measuring instruments and digital clocks (Fig. 6). Further uses could be in frequency displays, tape-position monitors for recorders, and other consumer goods.

When some of the fluorescent-plate and liquid-crystal improvements discussed come about, FLADs with smaller collection areas will be possible, such as the digital wristwatch of Fig. 7. Moreover, in the future the principle of fluorescence activation will be combined with multiplexed LCDs, where the fluorescent plate introduces no appreciable delay time. Multiplexed or time-shared displays are well suited to such applications as hand-held calculators and digital panel meters. □



GCR TECHNOLOGY IS MOVING INTO THE MINI-COMPUTER MARKET.

We are now shipping our 6250 bpi STC 1900 high density magnetic tape subsystem to OEM mini-computer customers. The STC 1900 is a 19-inch rack mountable, low-cost tape subsystem, that includes 1600 bpi as a standard feature.

This means that for the first time, mini-computers can offer the high performance features of much larger computers.

For the first time, you can offer 6250 bpi read-write capability with GCR format.

Now your customers can benefit from:

- **Increased throughput**
- **Almost four times the recording density of 1600 bpi**
- **Improved error correction (simultaneous two-track)**
- **Library interchangeability with other systems operating at 6250 or 1600 bpi densities**
- **100 megabyte disk dumps to one tape reel**

If improved system performance is important to you, the next move is yours. Call Frank Gunn toll free at 800-525-2940 or send coupon.



7-3877

STORAGE TECHNOLOGY CORPORATION

P.O. Box 6, Louisville, Colorado 80027

Please send me complete information about the new 1900 subsystem.

Name _____

Address _____

City _____

State _____ Zip _____

STC SHIPPING DEPT.



Low-cost logic analyzer displays Karnaugh map

by Prasert Jiraphasra
Chulalongkorn University, Bangkok, Thailand

Combine this simple hybrid circuit with an oscilloscope, and the result is a low-cost logic analyzer. It generates the deflecting voltages required for displaying a Karnaugh map of a four-variable logic circuit on the scope's cathode-ray tube. Both linear and digital elements are used to generate either the 0 or 1 numerals at each of 16 positions on the CRT.

As shown in Fig. 1, Q_1 and Q_2 form a 1-kilohertz oscillator, which is used as the external time base for the scope. The clock circuit drives the 7493 4-bit counter and the 7486 exclusive-OR gate array, both of which in turn drive a resistive ladder network. The network produces two four-value staircase waveforms. Four signals from the 7486 and 7493, A through D, cycle through a binary count of 0–15 sequentially and drive the logic circuit under test.

The waveforms produced by the ladder network feed

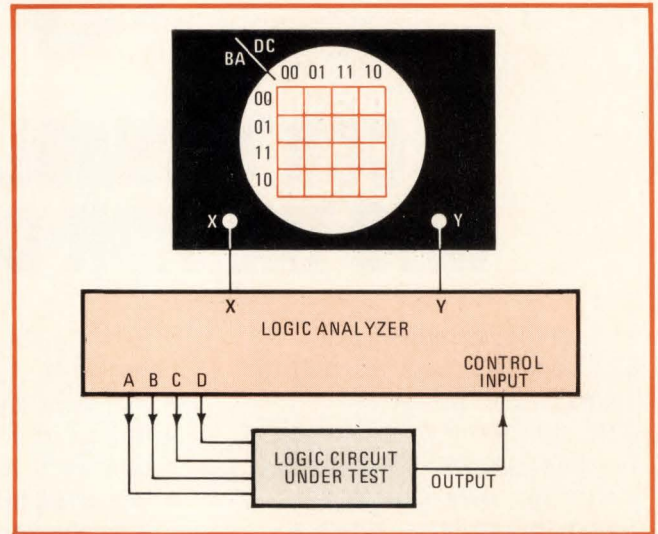

2. Test layout. Points A to D of analyzer drive logic circuit with 0–15 binary sequence. Monitored output point of logic circuit drives analyzer's control input. X and Y outputs of analyzer connect to scope inputs. Scope displays 0 or 1 in each of 16 areas on CRT.

into the inverting inputs of A_1 and A_2 , in order to provide stepped deflection voltages for the scope's vertical and horizontal amplifiers. These voltages deter-

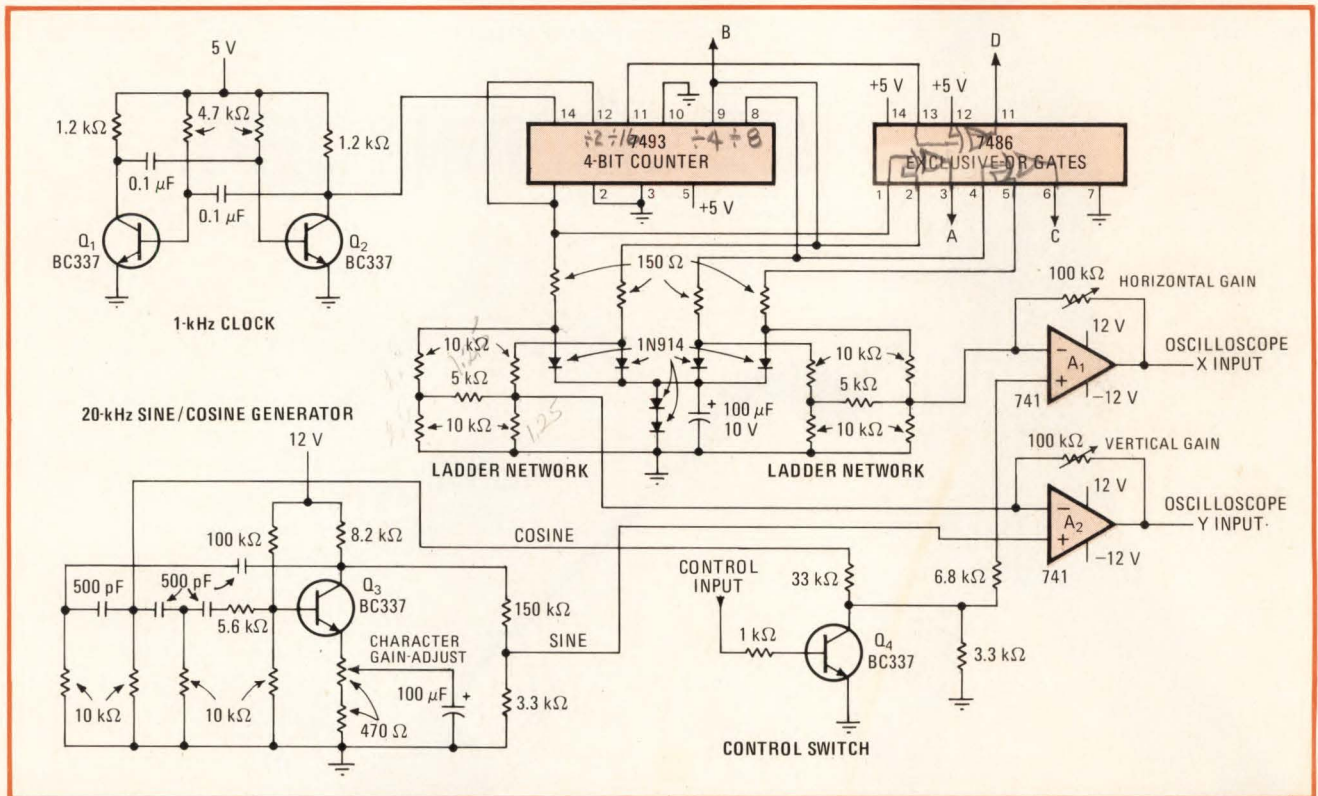

Logic analyzer. Circuit uses four-step staircase and sine/cosine generators to form 1s and 0s at any of 16 locations on scope. Logic 0 from circuit under test causes sine and cosine waveforms at A_1 and A_2 outputs, respectively, resulting in Lissajous pattern of a circle on scope. Logic 1 from device under test clamps A_1 to voltage produced by staircase generator, generating vertical straight line on scope.

mine the initial position of the scope trace at each of the 16 locations. To ensure that rows and columns line up and there is no uneven tilt in the numerals, clamping diodes are used. These diodes hold the output voltage from each pin of the counter constant and equal in amplitude throughout its switching interval. A sine/cosine generator running at 20 kHz is connected to the inverting inputs of A₁ and A₂; the sine wave directly, the cosine wave through control switch Q₄.

As illustrated in Fig. 2, only two interconnecting leads between scope and analyzer are necessary. The desired output of the circuit under test need only be connected to the control input of the analyzer, and the X and Y inputs of the scope to the X and Y inputs of the analyzer.

When the circuit point under test is at logic 0, then for

a given set of logic signals A, B, C, and D, the output of A₂ is a sine wave offset by a voltage produced by the ladder network. The output of A₁ is an offset cosine waveform. Because the two signals are equal in frequency but 90° out of phase, the waveform produced on the CRT is a familiar Lissajous pattern at the given location—a circle—which is interpreted as a logic 0.

If the circuit point under test is at logic 1, Q₄ turns on, holding the noninverting input of A₁ low, while A₂ varies sinusoidally at 20 kHz. Thus the waveshape on the CRT is a straight line positioned vertically at the location in question, which may be interpreted as a logic 1. Since the staircase generator steps at a 1-kHz rate as all 16 positions are examined in sequence, it appears to the viewer that all positions are simultaneously filled with a 1 or 0. □

Calculator notes

Hf communication program finds antenna's best fire angle

by Antonio Alberto Botto de Barros
Lisbon, Portugal

Determining the feasibility of high-frequency radio communication between any two points goes a lot faster with the HP-25 program described here. The HP-25 performs a rapid series of calculations on a single equation relating transmission distance and the height of the reflecting layers in the ionosphere to an antenna's vertical (firing) angle of radiation and the number of skips (hops). The program will determine the firing angle to which the antenna must be tilted to obtain the highest field strength at the receiving end. If the antenna cannot be steered in the vertical plane, the program can be used to ascertain whether the number of hops is

excessive for a given distance, layer height, and firing angle.

Despite the simplicity of the equation on which the program is based, the fact that the density and height of the layers are subject to diurnal, seasonal, and annual variations, plus the fact that the calculation does not take into account the exact frequency of operation, reasonably accurate results are obtained in the 3-to-30-megahertz portion of the spectrum.

The program solves the equation:

$$\tan^{-1} \beta = \frac{(h + R) \cos \alpha - R}{(h + R) \sin \alpha}$$

where:

$$\alpha = \frac{x}{nR} \frac{90}{\pi}$$

β = the firing angle

h = the height of the D, E, F₁, or F₂ reflecting layer

R = the radius of the earth

α = the angle measured from the center of the earth

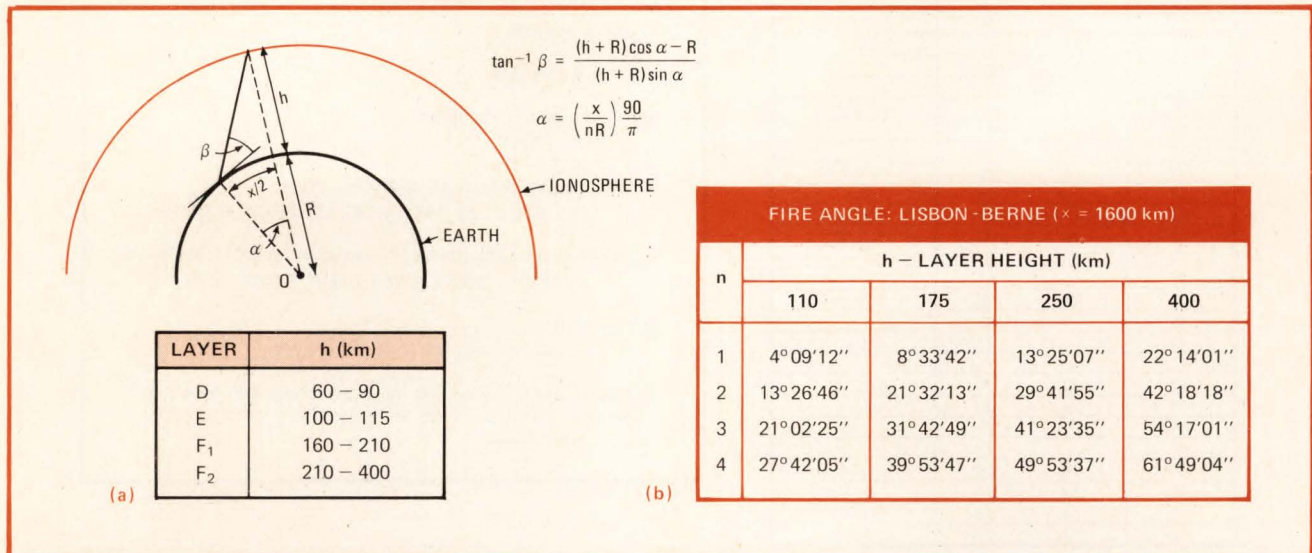

Ionospheric propagation. Antenna's firing-angle equation is derived from simple geometric considerations and yields fairly accurate results (a). Vertical angle of radiation required is tabulated versus layer height and hop number for the path separating Lisbon and Berne (b).

corresponding to the distance of a half hop

x = the distance between stations

n = the integral number of radio-signal hops.

This equation is based on the assumptions that the earth and ionospheric-layer surfaces are concentric, and that the angle of incidence is equal to the angle of reflection for radio waves striking the layer boundaries.

The equation is derived from the geometrical considerations shown in Fig. 1a. Given x , n , and several values of h , the program will determine the firing angle for each h and for integer values of n .

A simple example underscores the value of the program. In this case, the firing angles are sought for the path from Lisbon in Portugal to Berne in Switzerland, a distance of 1,600 kilometers. After the program has been keyed in, the x and h values and system constants are entered in registers R_0 through R_7 , respectively. Then pressing 0, R/S initiates the calculation for β . If the user wants to tabulate the data, O, R/S should be pressed

immediately after the first β has been found, to permit the calculator to advance to the second h for $n=1$. If just R/S is pressed, n will be incremented by 1, and β will be found for $n=2$ at the first specified h ; it will not be possible to then find β at $n=1$ at h_2 unless the program is reinitialized. The tabulated data is in Fig. 1b.

Unlike a general calculator program, this program requires that the user have a working knowledge of hf propagation in order to interpret the information generated—a blind reliance on the data produced is not possible. A knowledge of the relation of layer height and density to critical frequency, maximum usable frequency, etc., is necessary if one is to realize, for example, that it is not likely that a signal at 3 MHz can be made to traverse a distance of 1,600 km at $h=400$, $n=4$, and $\beta=61^\circ$, at high noon on any given day. □

Engineer's notebook is a regular feature in *Electronics*. We invite readers to submit original design shortcuts, calculation aids, measurement and test techniques, and other ideas for saving engineering time or cost. We'll pay \$50 for each item published.

HP-25 IONOSPHERIC PROPAGATION PROGRAM

LINE	CODE	KEY
01	14 11 00	f FIX 0
02	15 71	g x = 0
03	13 11	GTO 11
04	24 05	RCL 5
05	23 61 00	STO X 0
06	01	1
07	51	+
08	23 05	STO 5
09	23 71 00	STO ÷ 0
10	13 22	GTO 22
11	24 01	RCL 1
12	24 02	RCL 2
13	24 03	RCL 3
14	24 04	RCL 4
15	23 03	STO 3
16	22	R ÷
17	23 02	STO 2
18	22	R ÷
19	23 01	STO 1
20	22	R ÷
21	23 04	STO 4
22	24 05	RCL 5
23	14 74	f pause
24	24 04	RCL 4
25	14 74	f pause
26	24 00	RCL 0
27	24 06	RCL 6
28	71	÷
29	24 07	RCL 7
30	61	X
31	14 04	f sin
32	14 73	f Last x
33	14 05	f cos
34	24 04	RCL 4
35	24 06	RCL 6
36	51	+
37	61	X
38	24 06	RCL 6
39	41	-
40	21	x ↔ y
41	71	÷
42	24 04	RCL 4
43	24 06	RCL 6
44	51	+
45	71	÷
46	15 06	g tan ⁻¹
47	14 00	f → HMS
48	14 11 04	f fix 4
49	13 00	GTO 00

REGISTERS	
R ₀	x
R ₁	h ₁
R ₂	h ₂
R ₃	h ₃
R ₄	h ₄
R ₅	n ₀ = 1
R ₆	R = 6367 km
R ₇	90/π

INSTRUCTIONS

- Key in program
- Enter RUN mode
- Key in transmitting distance
(x), STO 0
- Input heights of D, E, F₁ and/or F₂ layers
(h₁), STO 1, (h₂), STO 2, (h₃), STO 3, (h₄), STO 4
- Store initial hop number, earth radius and equation constant
(1), STO 5, (6367), STO 6, (90/π), STO 7
- Press 0, R/S
Skip number, h₁, and fire angle is displayed.
- Press 0, R/S, to investigate the layers in sequence for a given skip number, or press R/S to increase the skip number for a given layer height.

The ULTIMATE mini-scope.

- 1.916

DMM

- AC, DC, Ohms
- Autoranging
- 3½ Digits
- 4 Ranges

99.61

COUNTER

- 50 MHz
- 4 Digits
- 5 Ranges
- 2 mV RMS Sensitivity

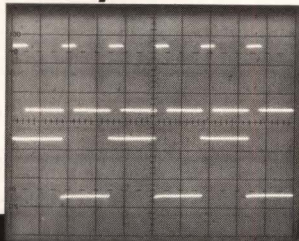
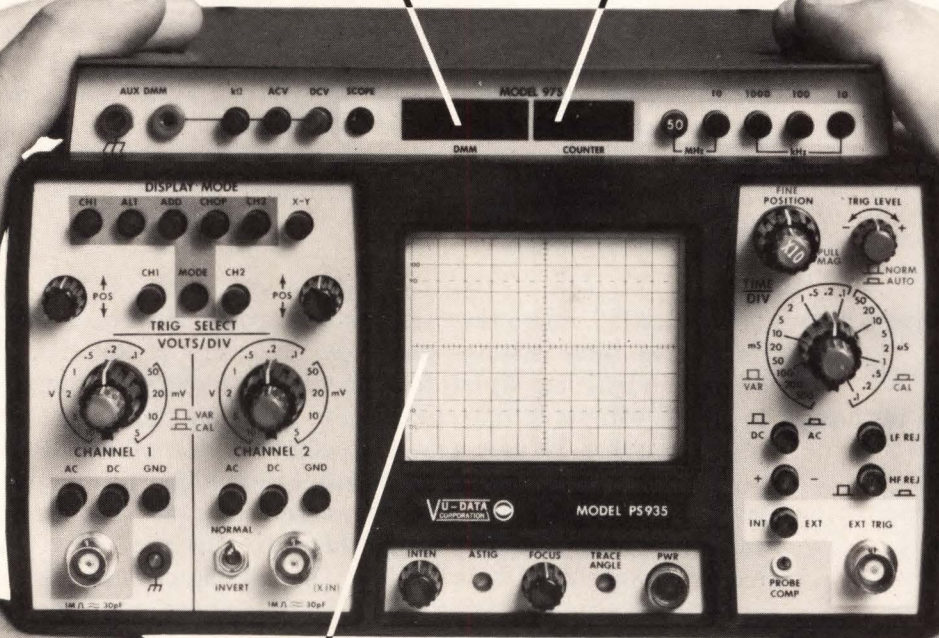

DUAL TRACE SCOPE

- 50 MHz Trigger Range
- 2 nsec Sweep Resolution
- 5 mV/div Sensitivity
- 35 MHz Bandwidth
- Delay Line
- X-Y Capability

50 MHz • **15 lbs** • **\$1,495**

HIGH PERFORMANCE in a SMALL, LIGHT WEIGHT PACKAGE sums up the value of this versatile test instrument. Never before has the measurement capability provided by Model PS935/975 DMM-COUNTER-MINI-SCOPE been offered in a single unit. And each of these three basic measurement tools can be employed independently, or as a complement to one or both of the other two.

Battery operation and a weight less than 15 lbs. make it ideal for field service applications, while vertical, horizontal and trigger circuit excellence qualifies this mini-scope for laboratory usage.

- **INTERESTED?** Call Hal Wardein at (714) 279-6572, or write to us at 7170 Convoy Court, San Diego, California 92111.

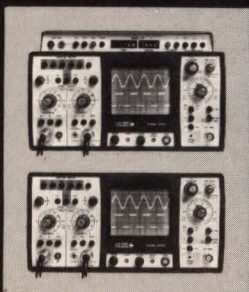

Model PS935/975
DMM-Counter-Mini-scope
\$1,895*

Model PS935
Mini-scope
\$1,495*

*U.S. Sales Price, F.O.B. San Diego, California

VU-DATA CORPORATION



A Leader in Portable Oscilloscopes
Circle 121 on reader service card

Ceramic capacitors respond noisily to shock

Are you getting intermittently high noise levels in your high-gain circuitry? The noise may be coming from an unsuspected source—ceramic chip capacitors. A paper in the Proceedings of the 1977 International Microelectronics Symposium by W. L. Robins and W. K. Jones of the Charles Stark Draper Laboratory and G. J. Ewell of Hughes Aircraft describes the piezoelectric behavior of multilayer monolithic ceramic chip capacitors. Results of this study showed that **under shock or vibration, part output voltages as high as 40 millivolts** were possible in BX type (K900 to 1800) ceramic capacitors. In low-level analog systems, this microphonic noise signal could conceivably mask the signal of interest or even saturate the circuits.

It's easy to broaden the range of a microwave test set

The HP 8755 microwave frequency response test set is often used for microwave filter testing—and David Layden of the Naval Avionics Facility in Indianapolis has found a way of extending its range from 60 dB to 100 dB without having physically to perform a radio-frequency substitution. In essence, he **uses a sweep oscillator's internal leveling/modulation p-i-n diode as the rf substitution device** by configuring it within the power leveling loop composed of the sweeper/frequency response set. An rf amplifier is then installed within the loop, after the device under test, to realize a range of 100 dB and up. The leveling capability of the sweeper and the ratio capability of the 8755 work together to provide a single trace display of the full dynamic range.

Application note AN 155-2 from Hewlett-Packard Co. describes the basic method plus some refinements. Copies can be obtained free from the company at 1507 Page Mill Rd., Palo Alto, Calif. 94304.

Cassette tells how stepping motors work

Stepping motors are an unfamiliar component to most electrical engineers. So if you are contemplating using one, you'll be interested in a new source of information on them. Superior Electric Co. is in the process of introducing a series of audio cassette tapes covering stepping motor technology. The first is now available for \$5, and it **covers stepper motor characteristics, power switching and drive techniques, and open- and closed-loop operation**. A printed text and a literature pack accompany the cassette. For more information, get in touch with Superior's Jack Wallace, 383 Middle St., Bristol, Conn. 06010; (203) 582-9561.

What all that hybrid-package terminology means

Designers of hybrid packages have their own jargon that sometimes seems created specifically to mystify users of these units. Terms such as AID, bathtub, bomb, etc., have no relation to their literal meaning. So Isotronics Inc. has issued the Encyclopedia of Hybrid Micro Circuit Packaging, a 74-page booklet that **explains and illustrates 200 terms for hybrid package construction, configurations, and materials, as well as applicable environmental tests and sealing methods**. The publication is available free of charge from the company, whose address and phone number are: 12 Coffin Ave., New Bedford, Mass. 02746; (617) 997-4575. **Jerry Lyman**

Solid State Scientific has over ten years of experience in developing successful custom CMOS circuits. Our track record includes devices for military programs, data processing, automotive applications, instrumentation, telecommunications, consumer products and most other applications using CMOS technology.

The successful development and production of a custom circuit begins with the problem to be solved. Our engineers will work

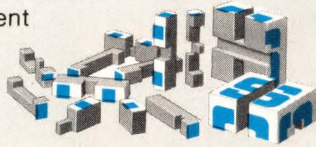

closely with you to define system requirements. We'll review the economy/performance tradeoffs involved in various design decisions and recommend the optimum approach for your application.

The next step is to translate a concept into a practical and reliable integrated circuit. Our advanced chip layout procedures provide a circuit with extremely high yields and what is generally the industry's smallest area. Computer-based mask tooling is produced in

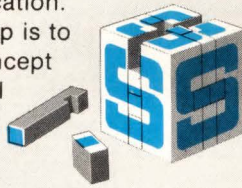

the SSS Image Design Center — the most advanced mask making facility anywhere.

To insure high reliability of your devices, our test engineering staff generate sophisticated procedures which provide full and thorough testing. In addition, prototype wafers are run in our production facility to eliminate any processing variation from prototype to production.

For complete information on our capabilities, write today for our new Custom Circuit Brochure. Solid State Scientific Inc., Montgomeryville, Pa. 18936. (215) 855-8400. TWX: 510-661-7267.



SOLID STATE SCIENTIFIC INC.

All sides of CMOS technology

**Custom
solutions
in CMOS,
a major
side of
SSS**



You Don't Have To Beg, Borrow Or Buy...

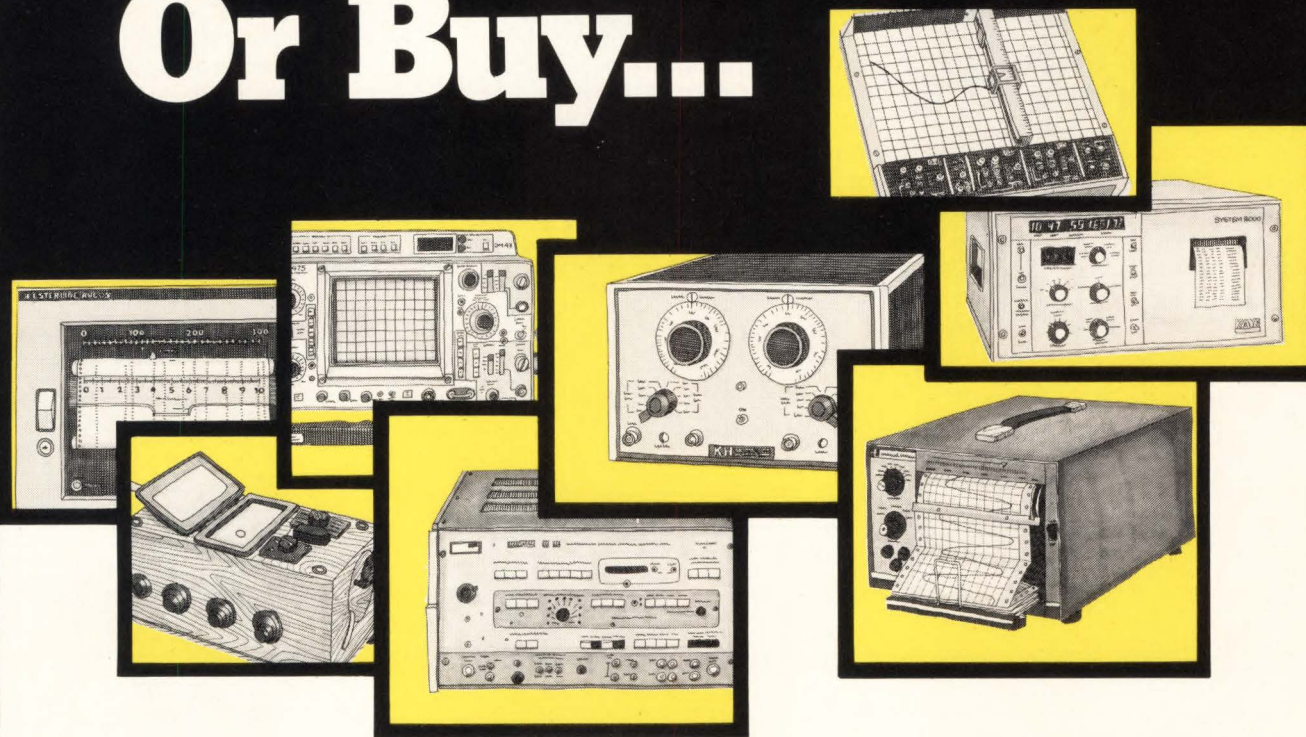

Rent'em From GE

Short or long-term instrument rentals give you flexibility and economy.

GE has over 9,000 instruments available for immediate shipment: □ Tek Scopes □ Biddle Megger Insulation Testers □ H-P Signal Generators □ Honeywell Oscillographs □ Complete Data Systems □ Esterline Angus Recorders □ GE Chart Recorders □ Modems □ Communication Terminals ... all calibrated to the manufacturer's specs.

We have over 100 Sales/Service Centers,

and one of them is near you. In addition to maintaining our Rental Inventory, they can also repair and calibrate your own equipment.

Don't borrow someone else's GE Rental Catalog. **Call collect (518) 372-9900** or your nearest Sales/Service Center.

**Quick-rental[®]
instruments**

GENERAL  ELECTRIC

ALA. BIRMINGHAM (215) 925-3104 • ARIZ. PHOENIX (602) 278-8515 or 8516, TUCSON (602) 294-3139 • CAL. LOS ANGELES (213) 642-5350, SAN FRANCISCO (415) 436-9260 • COL. DENVER (303) 371-1260 • CONN. SOUTHINGTON (203) 621-4059 • FLA. JACKSONVILLE (904) 751-0610 • GA. ATLANTA (404) 457-5563 • ILL. CHICAGO (219) 933-4500 • IND. INDIANAPOLIS (317) 639-1565 • KY. LOUISVILLE (502) 452-3311 • LA. NEW ORLEANS (504) 367-6528 • MD. BALTIMORE (301) 332-4700 • MASS. BOSTON (617) 396-9600 Ext. 160, SPRINGFIELD (413) 781-1111 • MICH. DETROIT (313) 285-6700 Ext. 208 • MINN. MINNEAPOLIS (612) 522-4396 • MO. KANSAS CITY (816) 231-4377, ST. LOUIS (314) 965-7115 • N.J. CLIFTON (201) 471-6556 • N.Y. BUFFALO (716) 876-1200, SCHENECTADY (518) 385-2195 • N.Y.C. CLIFTON, N.J. (201) 471-6556 • N.C. CHARLOTTE (704) 525-0311 • OH. CINCINNATI (513) 874-8512, CLEVELAND (216) 523-6382, TOLEDO (419) 691-3501 • OR. PORTLAND (503) 221-5101 • PA. PHILADELPHIA (609) 424-4450, PITTSBURGH (412) 462-7400 • TEX. DALLAS (214) 357-7341, HOUSTON (713) 672-3570 • VA. RICHMOND (804) 232-6733 • WASH. SEATTLE (206) 854-0211 • W.V. CHARLESTON (304) 345-0920 • WISC. MILWAUKEE (414) 744-0110 • PUERTO RICO PONCE (809) 843-4225.

Power sensor handles optical jobs

Dedicated to the measurement of optical power, Hewlett-Packard instrument teams up with power meters to help in fiber-optic system analysis

by Richard Gundlach, Communications and Microwave Editor

The dynamic growth of fiber-optic systems has brought with it a need to assess their transmission characteristics accurately and to verify exactly how their optical components are performing. A critical parameter is the power output from the light-emitting diode or laser light source, making it essential to be able to take separate measurements of the power radiated by the sources, the power coupled from the source into the transmitting end of the optical fiber, and the attenuation of the length of fiber cable used.

What's more, not only must insertion loss of splices, connections, and couplers be determined, but a measure of the sensitivity of avalanche- and p-i-n photodiodes and the degree of deviation from a square law response is useful. Some of the measurements need be only relative, but to evaluate the system completely, at least one power measurement has to be absolute and traceable to fundamental standards.

Hewlett-Packard's newly developed optical power sensor, model 84801A, is the first of its kind to be dedicated to measuring absolute optical power. It is designed to plug into any of HP's model 432 series of power meters to display the optical power conveniently in units of watts or dBm. The power meters provide an adjustment to match the calibration factor of the sensor, which accounts for spectral response and power-conversion efficiency, thus making absolute power readings possible.

The combination of sensor and power meter measures optical power from 1 microwatt (-30 dBm) to 10 milliwatts ($+10$ dBm) over a wave-

length range of 600 to 1,200 nanometers to within an absolute accuracy of $\pm 8\%$. No special spectral cali-

bration curves are needed and, since a substitution method is used to determine power, the sensor can be

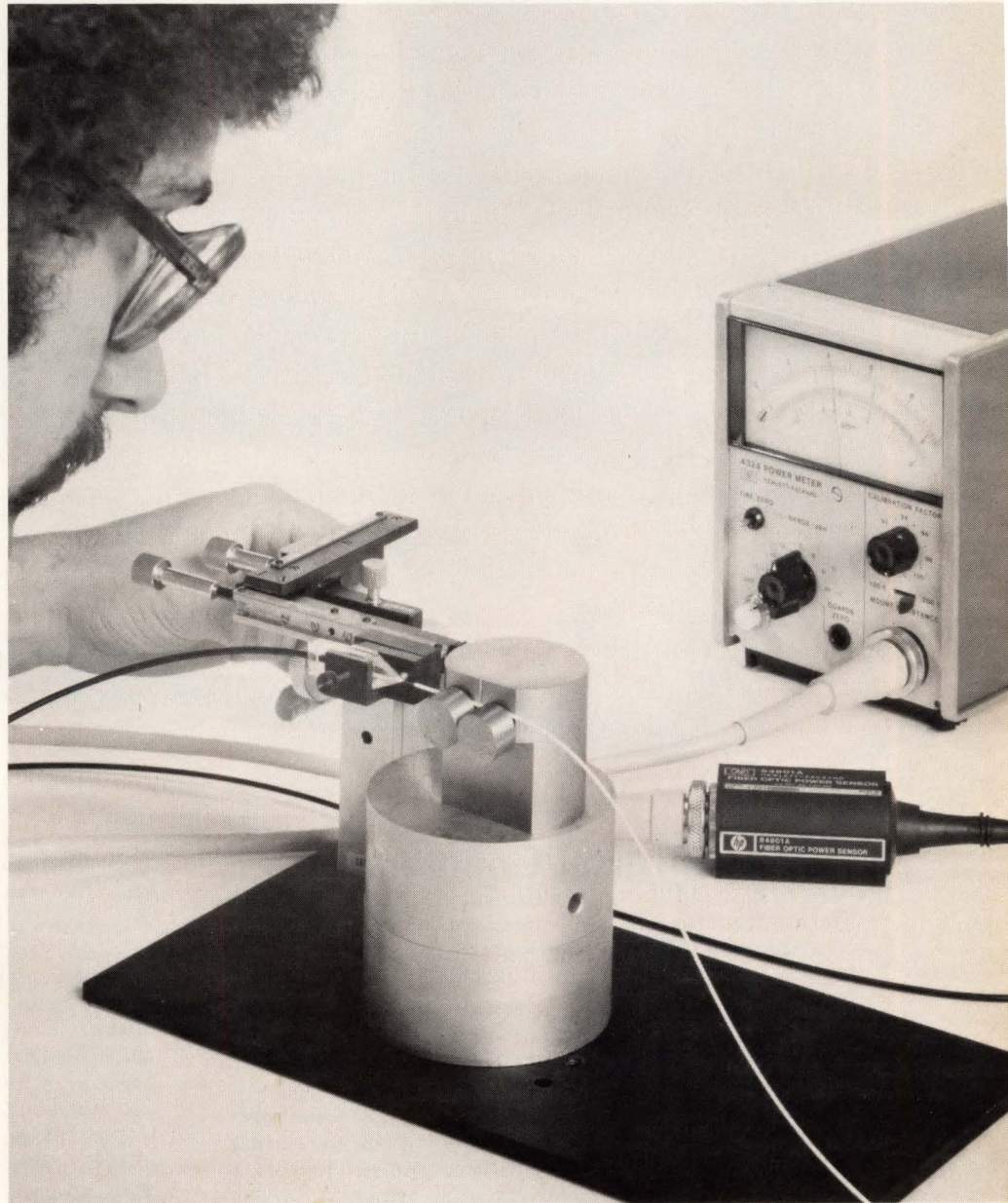

New products

traced to NBS standards through the channels of dc substitution.

In microwave power measurements, signal power is caused to dissipate inside a thermistor bead, the resistance of which changes with temperature, and a separate dc-balancing power is withdrawn in a special balanced-bridge arrangement. This "substitution" power comes close to equaling the power of

the microwave signal.

In like fashion, the substitution power will come close to equaling the optic power. Thus, when optical power is applied to a thermistor placed in one leg of a Wheatstone bridge and balanced by a dc bias voltage, the heating effect causes the thermistor's resistance to decrease, unbalancing the bridge in proportion to the applied signal power. The

bridge is brought back to balance by decreasing the dc bias. The difference in bias power required to maintain the thermistor's resistance at a constant level both with and without the power coupled into the optical fiber is a measure of the optical power.

Because of the lack of optical-connector standardization, a 1-meter length of a large-diameter, re-

One way...



HP's Universal Counters

satisfy the needs for most electronic counter measurements up to 1300 MHz, and do it without breaking your budget. Two distinctly different models are loaded with features, and a wide variety of options are available.

One way is the 5328A for high performance frequency, period and time interval measurements in a modular 8 or 9-digit unit for systems or bench use. Start with the basic 100 MHz/100 ns unit for just \$1300*. Modules expand its capabilities to 512 or 1300 MHz for frequency, 10 ns for time interval and add 10 μ v to 1000v, digital voltage measurements. Other options include ultra-stable time base, and full HP Interface Bus operation. Standard at no extra cost are burst frequency measurement and time interval averaging to

10 ps resolution... matched input amplifiers make this resolution meaningful.

The other way is the 5300B/5308A System for lower cost yet highly versatile 8-digit frequency, period and time interval measurements in a modular portable package that also can be rack mounted. In just 30 seconds, snap on any of 10 other modules including: a full capability DMM, battery pack and 1300 MHz and HP Interface Bus modules. The 5300B/5308A's low \$910* price even includes time interval averaging for resolution to 1 ns!

Use the 10855A Preamplifier for higher sensitivity with any model: 22 dB gain, 2 to 1300 MHz for just \$225*

To do it your way contact your nearest HP field engineer for full data, or write.

*Domestic U.S. prices only.

cleavable single fiber is connected to the sensor. This lets the user attach the other end of the fiber to any connector he chooses, or instead use the plastic protective element supplied with the sensor.

This element allows a fiber to be slipped into it and meet with the end of the fiber cable not attached to the sensor. Since the 200-micrometer fiber diameter is larger than the

diameter of most high-performance optical fibers, this approach eases the problem of achieving low-loss coupling when making measurements.

The power meter series provides the circuitry for automatic bridge balancing and the metering logic that is necessary to convert the resistance change of the thermistor in the 84801A sensor into optical

power readings displayed on the power meter selected.

The price of the sensor is \$500, and delivery time is 4 to 6 weeks. For those who do not already have a power meter, prices start at \$800 for model 423A. Delivery time is also 4 to 6 weeks.

Hewlett-Packard Co., Inquiries Manager, 1501 Page Mill Rd., Palo Alto, Calif. 94304. [338]

or the other,



the right performance at the right price.

HEWLETT  PACKARD

1507 Page Mill Road, Palo Alto, California 94304

For assistance call: Washington (301) 948-6370, Chicago (312) 255-9800, Atlanta (404) 955-1500, Los Angeles (213) 877-1282

Analog I/O mates with 16-bit computer

Interfacing directly with TI's 990/100 single-board microcomputer, line of six analog subsystems offers flexibility, ease of use.

by Larry Curran, Boston bureau manager

Anticipating that Texas Instruments Inc. will capture a significant share of the single-board microcomputer market by 1980, Analog Devices Inc. has chosen TI's 16-bit TM-990/100 series as the mate for its latest analog input/output interface subsystems. Fred Pouliot, product line manager for microcomputer peripherals at Analog Devices, believes the linkup represents both performance and cost advantages over popular 8-bit systems.

There are six boards in the Analog Devices line. The RTI-1242 series available this month, is a four-channel output subsystem. An eight-channel version, the RTI-1243 series, will also be available by year's end. They will be followed in January by the RTI-1240 input subsystems, with up to 32 single-ended (16 differential) onboard input channels, and the RTI-1241 I/O subsystems. The latter has the same number of channels as the 1240 but offers some additional features.

The 1240-R input board can be expanded to 256 input channels with onboard logic. It offers a resistor-programmable-gain instrumentation

amplifier with gains of 1 to 1,000, input fault protection to 20 volts beyond the supply voltage, as well as a 12-bit analog-to-digital converter. With the 1240-S input board, the user gets a software-programmable-gain instrumentation amplifier with gains of 1, 2, 4, and 8. Both boards provide software-enabled end-of-conversion interrupt that Pouliot says results in efficient polling, with the setting of the end-of-conversion bit in the status word creating the central-processing-unit interrupt, and reading of the status word clearing both the end-of-conversion bit and the interrupt.

The 1241-R and 1241-S offer all of the features of the 1240 boards, plus two 12-bit d-a converters accommodating two output channels. It goes beyond the 1240 with a few other features, as well: the d-a converters reset to zero volts when the system is reset, and there is an onboard or external reference capability and optional 4-to-20 milliamper current-loop outputs. All the boards in the new series provide memory-mapped interfacing, which Pouliot says results in high throughputs and software efficiency.

The 1242 and 1243 output subsystems are identical in design, except the latter has four more d-a converters providing eight output channels vs the 1242's four. The converters are 12-bit units, and both subsystems provide software-controlled, 300-milliamper logic-driver outputs. About the logic drivers, Pouliot says: "We've learned that people who buy output boards are using them to open or close a relay, shut off a motor, or lift a pen on a chart recorder, but that's a tremendous

waste of the converter's capability. Anything that can be run by a relay can be run by these logic drivers at up to 30 v at 300 mA."

Both the 1242 and 1243 also provide full converter and driver data-readback capability. For this feature, Pouliot says the company has provided semiconductor random-access memories in sockets on the boards, "and every time we send information to the converter on a given channel, the same data goes into RAM and can be read back later, a nice software convenience."

The 1242 and 1243 also have on-board or external reference capabilities, but it is a single reference in either case. That is important, Pouliot explains, because with one reference for all the converters, they will have proper tracking between them and less power will be consumed than with multiple references. Both boards additionally offer jumper-selectable system reset for the converters and drivers, a remote load-sensing capability on each converter and independent converter range and code selection.

Remote load sensing is an attractive feature when the load may be several feet from the system. As for independent range and code selection, any of five voltage output ranges and three input codes can be selected for each channel.

In quantities of one to nine, prices for the boards are as follows: \$445 for the 1240-R, \$495 for the 1240-S, \$560 for the 1241-R, \$610 for the 1241-S, \$395 for the 1242, and \$675 for the 1243.

Analog Devices Inc., Route One Industrial Park, P. O. Box 280, Norwood, Mass. 02062. Phone (617) 329-4700 (339)

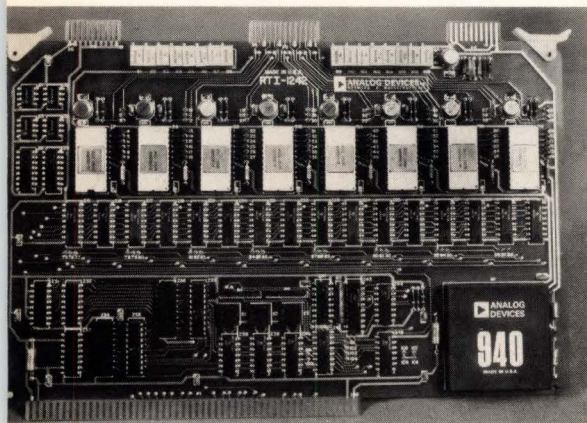

READ THESE TEN CHAPTERS. AVOID CHAPTER 11.

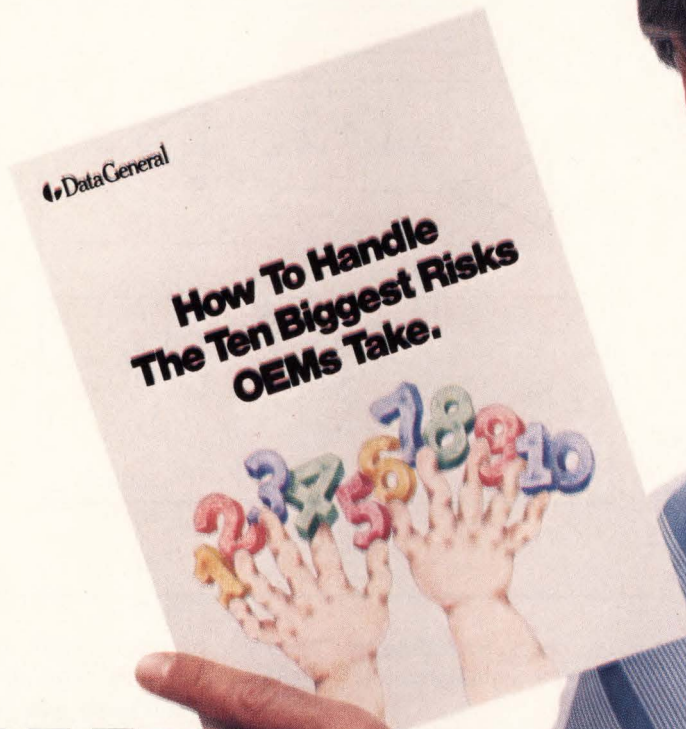

- I want to see how a computer vendor can help me. Send me your book today.
- I'm too busy to read another book. Have your salesman come and show me the way.

Name _____
Title _____
Company _____
Department _____ Phone _____
Address _____ City _____
State _____ Zip _____

Data General, Westboro, MA 01581, (617) 366-8911. Data General (Canada) Ltd., Ontario.
Data General Europe, 59-65 rue de Courcelles, Paris, France. Data General Australia, Melbourne (03) 82-1361.



We make computers that make sense

EX-128

© Data General Corp., 1977

Analog multiplier compensates itself

Internally correcting for nonlinearity, general-purpose bipolar chip holds error to as little as $\pm 0.1\%$, offers 4-MHz bandwidth

by William F. Arnold, San Francisco bureau manager

In precision analog multipliers, designers generally have to choose between highly accurate hybrids or modules that also carry fairly high price tags or cheaper monolithic approaches that also do not perform quite as well. Raytheon, however, believes it has a general-purpose multiplier chip that combines the best of both worlds.

Called the RC4200, the chip is the first integrated-circuit multiplier to compensate for nonlinearity. To back up its claim, the Mountain View, Calif., company quotes a nonlinearity specification at room temperature of $\pm 0.3\%$ for the standard version and $\pm 0.1\%$ for the spiffy.

Moreover, Raytheon says that it can be used in a wide variety of applications, including four-quadrant multiplication, one-quadrant division, square-rooting, and rms-to-dc conversion. It also features a temperature coefficient of total error of only $\pm 0.005\%$ per $^{\circ}\text{C}$ and a bandwidth of 4 megahertz.

Prices, however, are competitive with other monolithics. In hundred quantities, the standard RC4200 costs \$4.25 each and RC4200A is priced at \$6.50.

Armed with those attributes, the chip is poised to attack various applications on a wide front, says Paul Pinter, linear marketing manager. Besides industrial control and instrumentation, potential communications and signal-processing applications include modulation and demodulation in autopilots, phased-lock-loop circuits in acoustic data modems, automatic gain control in noise reduction systems, as well as voltage-controlled oscillators and voltage-

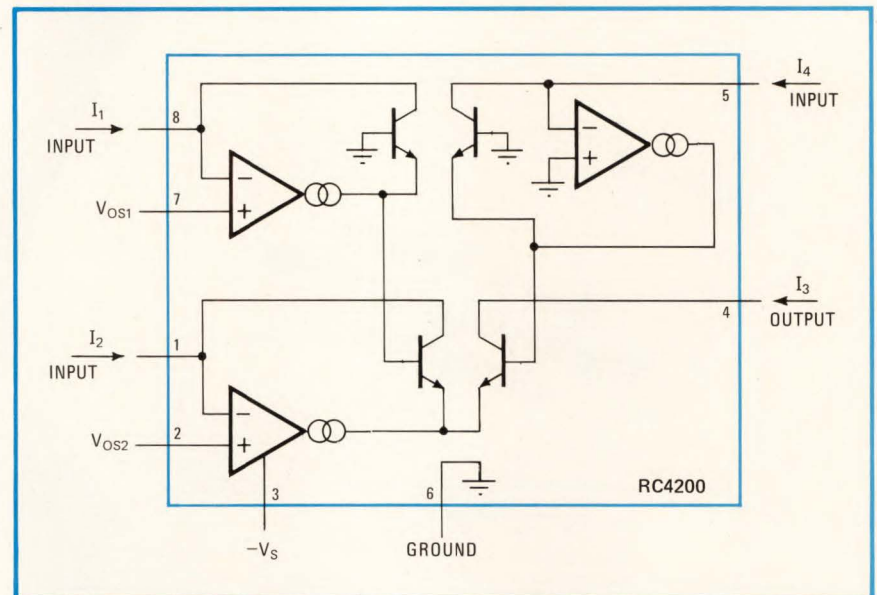

controlled active filters, according to Thomas M. Cate, advanced products marketing manager.

However, as a general-purpose "current in, current out" multiplier, the RC4200 needs various external networks of resistors and operational amplifiers to make it go through its various functions. Cate, a co-designer of the chip, says that the RC4200 is intended as a current-driven device to give it versatility.

To get the versatility and performance, Raytheon employs several proprietary design techniques to put a trio of frequency-compensated operational amplifiers on the 66-by-78-mil bipolar chip. "Each op amp is basically just a high-gain amplifier with special feedback," notes Cate.

Frequency compensation is provided by a logging transistor in the feedback loop of each op amp, forming a log/antilog circuit to produce an output current that is the

product of two input currents divided by a third. The key to the 4200's compensation scheme is a second set of transistors. Essentially, the logging transistors are not only matched but each also has its own associated sister transistor to compensate for transistor log conformity errors. Adds Cate, the 4200 operates over an input range of 1 microampere to 1 milliampere and over a supply range of -9 to -18 volts, drawing only 4 mA maximum.

Raytheon, which is now supplying samples of the 4200, plans to be in production by the first quarter of 1978. Packaged in an 8-pin plastic dual-in-line package for commercial (0°C to 70°C) use, the 4200 will also be available in military (-55°C to $+125^{\circ}\text{C}$) and industrial (-40°C to $+85^{\circ}\text{C}$) versions.

Raytheon Semiconductor, 350 Ellis St., Mountain View, Calif. 94042. Phone (415) 968-9211 [340]

The snap action switch

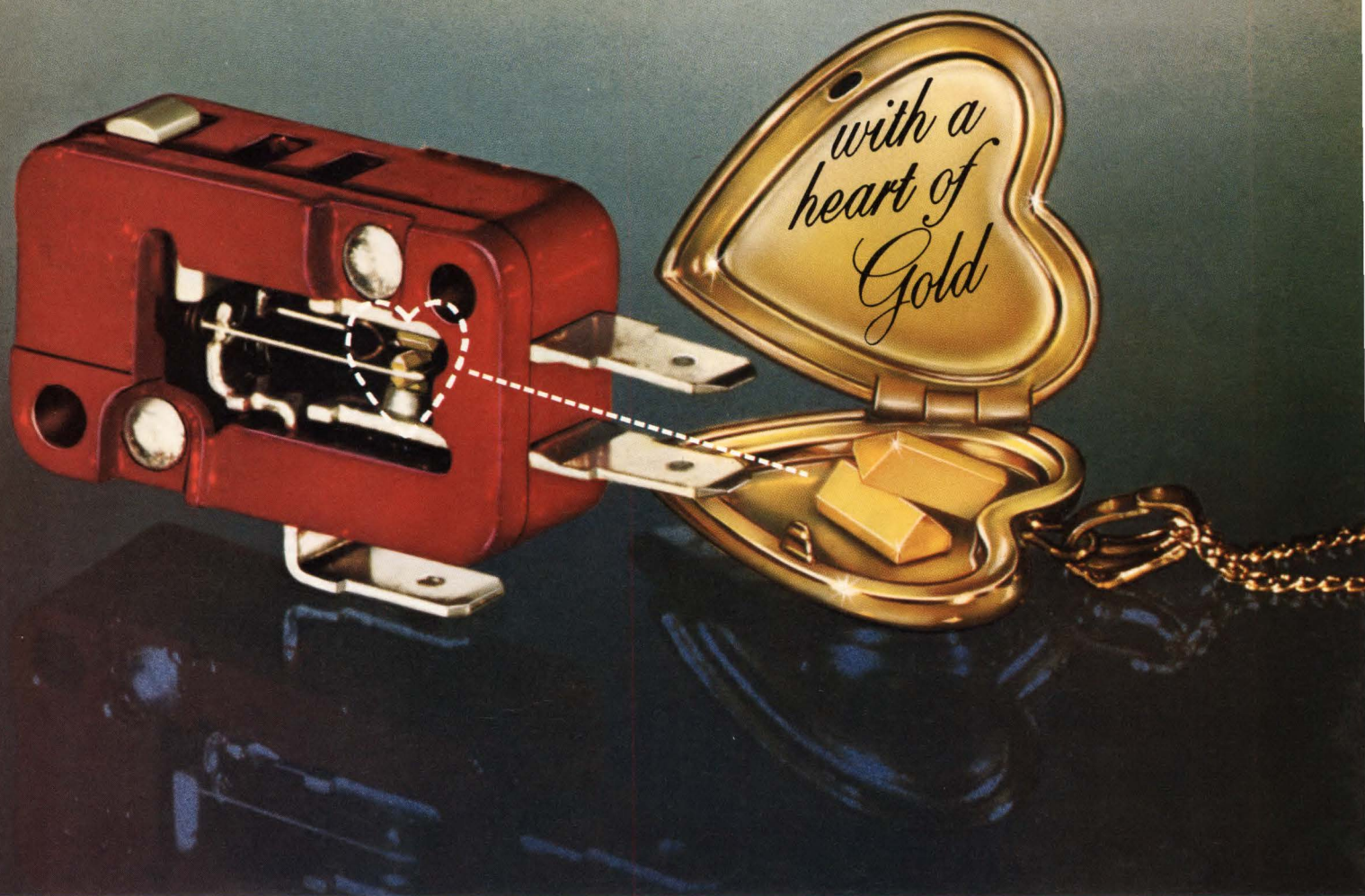

...for **POSITIVE** switching in low energy circuits

Now your 4 to 100 milliamperere, 4 to 30 volt circuits can have the same high reliability you've learned to love in Cherry snap action switches. Because, our "heart of gold" snap action switches have the same long life coil spring mechanism, the same large overtravel as all of our snap action switches.

They also have gold crosspoint contacts. A configuration with knife-edge contact area so small (9 millionths of a square inch)... with contact force so great (about 5,000 psi)... and gold alloy so pure and film-free... you are absolutely assured of positive contact every time. For 50 million operations and beyond.

Cherry Gold Crosspoint Contact Switches are available in virtually every snap action design in

Cherry's big catalog. And you *know* what a wide variety of switch types, sizes and mounts *that* is. Choose any switch design from a basic open or general purpose to a panel mount pushbutton, low torque, miniature, subminiature or subminiature module. Chances are 99 to 1 that the switch you have chosen is available with gold crosspoint contacts. Which will make designing low energy circuits a whole lot easier... and a whole lot *better*. (No love letters, please.)

For free test sample and complete catalog, just TWX 910-235-1572... or PHONE 312-689-7700.

CHERRY 

Cherry switches now available locally from distributors.

CHERRY ELECTRICAL PRODUCTS CORP., 3608 Sunset Avenue, Waukegan, IL 60085

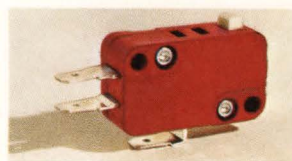

**About the only No Touch Controls we don't make
you haven't asked for. Yet.**

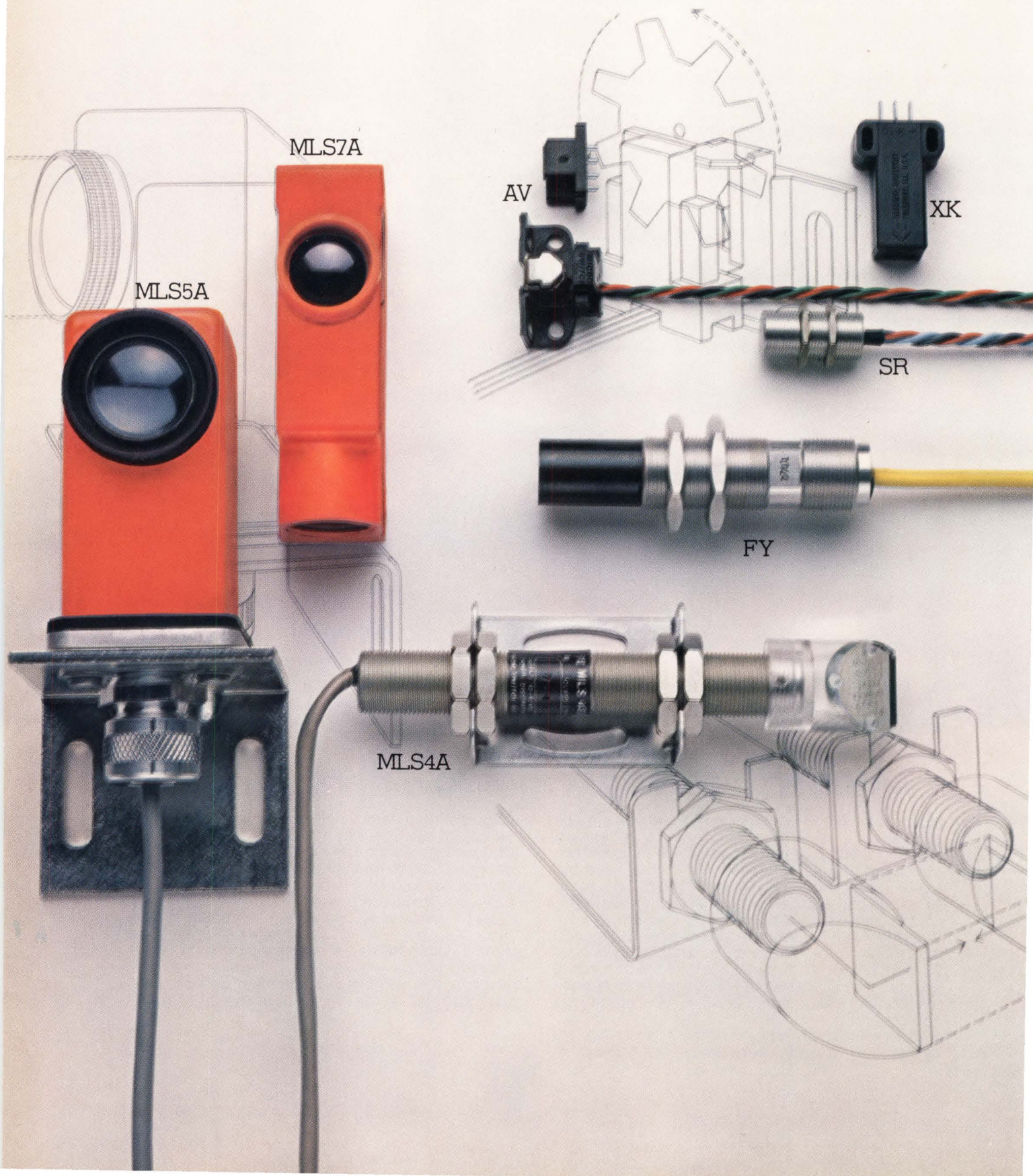

are the ones

For years, MICRO SWITCH has been the leading maker of No Touch Controls.

That's because we're also leaders when it comes to listening to switching problems where mechanical devices just don't fill the bill. And then solving them with industry's broadest line of photoelectric and proximity controls.

For example, the ferrous-sensitive XK can detect metal targets of any thickness, either moving or stationary. There's also the vane-operated AV and the magnetically operated SR, both featuring dependable Hall-effect technology and high speed operation unaffected by dust and dirt.

You can also choose from a wide selection of solid state FY proximity sensors designed to be directly compatible with programmable controllers and solid state logic. These self-contained controls have models ranging from 14 mm in diameter to 76 mm.

For materials other than metals or where distances are too great for proximity switches, MICRO SWITCH offers a complete line of photoelectric controls.

At shorter distances, choose from MLS4A controls with a range of 8 feet or MLS7A controls that scan up to 10 feet. Both are DC powered and use advanced integrated circuitry to increase reliability.

There are also models with much greater scanning ranges, like the high intensity MLS5A that sees up to 250 feet in clean air and through dust, smog, steam and other pollutants at shorter distances.

Another model provides a scanning range up to 700 feet.

And whether you need proximity or photoelectric controls, you'll be getting solid state design that delivers long life. Which is what you've come to expect from the leading maker of No Touch Controls.

MICRO SWITCH will provide you with field engineers for application assistance and a network of authorized distributors for local availability. Write us for details or call 815/235-6600.

MICRO SWITCH

FREEPORT, ILLINOIS 61032

A DIVISION OF HONEYWELL

MICRO SWITCH products are available worldwide through Honeywell International.

New products

Data handling

Analog I/O boards work with M6800

Subsystems offer high throughput, flexibility, and multiple-channel capability

With a family of three analog input/output subsystems for the Motorola M6800 Exorciser microcomputer, Datel Systems Inc. officials maintain that they are offering users an attractive combination: the ability to handle as many data channels as possible, fast throughput, and configuration flexibility. The new series, called the ST-6800, consists of a combination analog-to-digital and digital-to-analog master board, an a-d slave expander board, and an independent d-a master board.

Lawrence Copeland, product marketing manager for computer peripherals products, says his company's offerings improve on competitive single-ended units for the Motorola microcomputer by offering up to 32 single-ended (or 16 differential) channels versus 16 single-ended ones and by improving on throughput. The throughput period of the Datel

units is 20 microseconds.

All three boards slide directly into the Exorciser's card slots and are electrically and mechanically compatible with the microcomputer bus. Their memory-mapped architecture makes the data appear to the central processing unit as any consecutive block of 512 memory locations, with a jumper-selectable base address. The master a-d-d-a board, the ST-6800, offers two optional d-a output channels. The input section can accept voltages of 0 to +5 v, 0 to +10 v, ± 5 v and ± 10 v. The board gets its power from the microcomputer plus the 5-v bus, but can include an optional ± 15 -v dc converter to drive the analog circuits on the board.

The minimum configuration of the ST-6800, with 16 single-ended channels, sells for \$419 in single quantities. The dc-to-dc converter and tested, installed d-a converters are optional at extra cost. The ST-6800AD slave expander board gives users the flexibility of expanding the a-d input channels in increments of 32 or 48. The ST-6800 master is required for control, and two expander boards can be linked to provide up to 128 single-ended channels.

The third board, the ST-6800AD, is a stand-alone d-a peripheral, providing four or eight d-a output

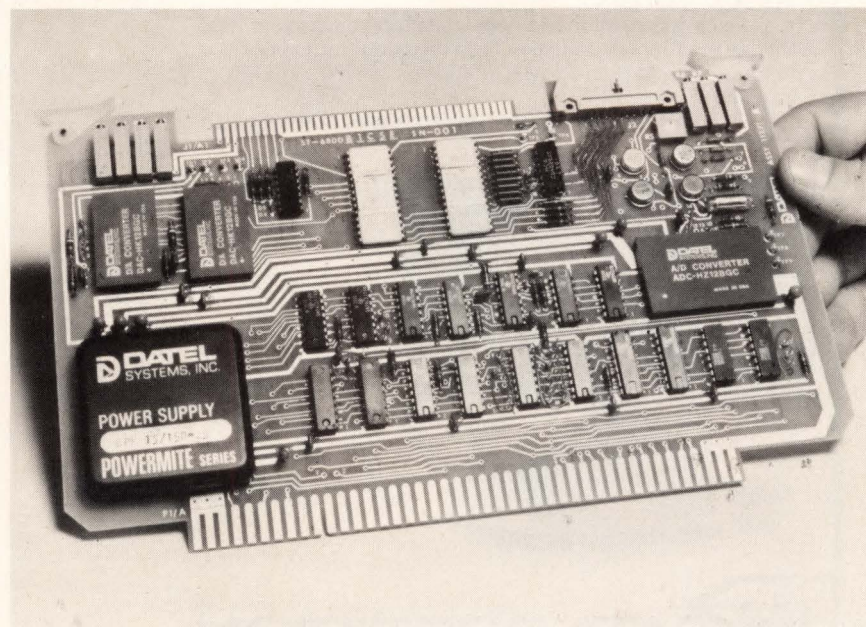

DMM Sensitivity: Never Have We Packed So Much Of It Into Such a Small Package, \$345 Complete.

No other 4½-digit portable multimeter gives you 10µV DC and AC sensitivity, True RMS AC voltage and current measurement along with unsurpassed ±0.05% basic DC accuracy, guaranteed for one year—in a truly portable, easy-to-read instrument.

Model 248 measures:
Resistance 100mΩ to 20MΩ
DC Volts ±10µV to ±1KV,
True RMS AC Volts 10µV to
500V, both DC Current and True RMS AC Current 10 nanoAmps to 2A.

Small, Light, Easy-to-Read

Just 1¾" x 5½" x 3½" (4.45 x 13.97 x 8.89 cm) and only 1.3 pounds, the 248 has only 2 controls—Function and Range—and a bright 0.3 LED display for easy viewing.

Extras Included

You also get these standard accessories: a rechargeable NiCd battery module, a pair of test leads, line cord with charger, carrying case, and full instruction manual and test data. A full range of optional accessories is also available.

Price: \$345* complete.

For complete information or a demonstration, contact your local Data Precision representative or Data Precision Corporation, Audubon Road, Wakefield, MA 01880, (617) 246-1600. TELEX (0650) 949341.

*price USA

Circle 134 on reader service card

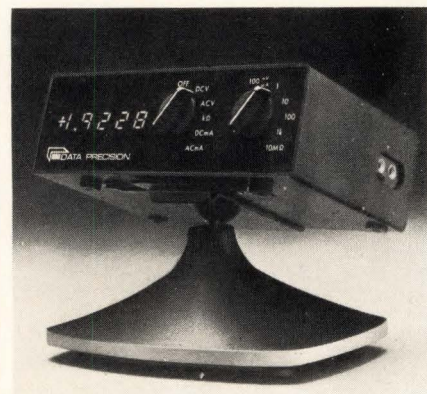
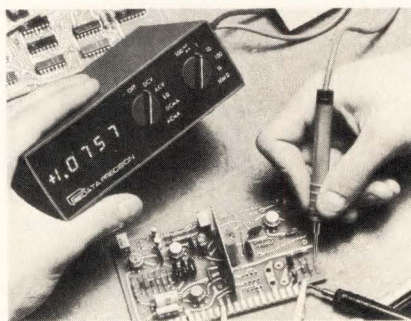

DATA PRECISION®
...years ahead

New products

channels, and can be hard-wire-addressed to any block of 16 memory locations. Copeland says the d-a boards can be cascaded in groups of eight to give up to 256 single-ended channels.

He says applications for the ST-6800 series include industrial process control, high-speed automatic test systems, and programmable data-acquisition systems, with the on-board a-d converters especially suitable for driving chart recorders, X-Y plotters, and oscilloscopes. Datel provides diagnostic and prototyping software on paper tape with each subsystem, to get users operating quickly. Delivery time is four to eight weeks after ordering.

Datel Systems Inc., 1020 Turnpike St., Canton, Mass. 02121. Phone Lawrence Copeland at (617) 828-8000 [341]

Analog I/O systems

work with TM-990/100

A pair of analog input/output interface subsystems for the Texas Instruments TM-990/100 microcomputer are Analogic Corp.'s latest effort in the increasingly competitive race to give microcomputer users a means of accommodating analog signals. The ASC1080 and ASC1081 were announced last week, and will be available in production quantity by early February, the company says.

The ASC1080, in four versions, incorporates from 16 to 64 single-ended input channels (8 to 32 differential), while the ASC1081 output board offers one to four channels of current outputs from 4 to 20 milliamperes, or voltage outputs of ±10 v. The latter also comes in four versions, depending on the number of channels desired. The products are the Wakefield, Mass., company's first end-user microcomputer interface boards, but Analogic has been supplying similar hardware to Intel, TI and Zilog on an OEM basis.

The input unit is built around Analogic's MP6812 data-acquisition module, which uses a high-performance, 12-bit successive-approxima-

The complete \$655 line printer.

It's ready to plug in, has an 80-column format, a remarkable MTBF and is 14 times faster than a teletype!



Breaking the hardcopy barrier

It's finally happened! The Axiom EX-800 provides full performance hardcopy at a price compatible with today's low cost micros. This little 80-column machine zips along at 160 characters per second (14 times faster than a teletype) — at a breakthrough single quantity price of \$655 for a complete printer.

When we say complete we mean it

The EX-800 is a stand-alone unit with case, power supply, 96 character ASCII generator and interface, paper roll holder, infra-red low paper detector, bell, and multi-line asynchronous input buffer. You won't find these standard features on any other printer, regardless of price!

Our only option

Our printer is so complete, that we offer only one option. A serial interface (RS 232C or current loop) good for 16 baud rates from 50 to 19,200 and thoughtfully provided with a switch for either Centronics or Tally compatibility. Might we call it a Tally-whacker? At \$85.00 it certainly should be!

Built-in LSI microprocessor

The heart of the EX-800 is a printed circuit card, containing a custom LSI chip made by Intel to Axiom specifications, which controls all printer functions. Microprocessor power means flexibility. Such as the built-in self test routine and variable



character size. It also means reliability. Several industry surveys have shown LSI to be many times more reliable than equivalent conventional circuitry.

THIS LIFE-SIZE SAMPLE SHOWS THE 80-COLUMN PRINTOUT FROM AXIOM'S EX-800 PRINTER
There are 3 character sizes (upper and lower case) which can be MIXED.
This can have the same effect as UNDERLINING or changing COLOR.

The advantages of electrosensitive printing

The EX-800 can print 80, 40, or 20 characters across the five inch wide electrosensitive paper. Under software control, single characters or words may be printed larger for emphasis. The permanence of the hardcopy is archival, because once the aluminum coating has been removed, there is no way to put it back. It's unaffected by sunlight, moisture or heat. Although the printer doesn't provide multiple copies, excellent quality photocopies can be made from the high contrast printout. Also,

the paper is inexpensive and readily available, costing about 1¢ for an 8½ x 11" equivalent.

Light, small, quiet, reliable, and versatile

Our EX-800 weighs in at 12 pounds, is just 9½ inches wide, 4 inches high, and 11 inches deep, and is delightfully quiet which makes it ideal for office and other low noise environments. The simple print mechanism is virtually maintenance free. In fact, tests show an incredible MTBF, many times greater than impact printers. This versatile printer is the ideal mate for micros, minis, CRTs, instruments and systems.

Just unbox and plug it in

That's all you have to do to the Axiom EX-800 — apart from pay for it, and at \$655 that's almost a pleasure.

Send to: **AXIOM**
5932 San Fernando Rd.,
Glendale, CA 91202

- Urgent. Please phone me at ext _____
- Have rep contact me
- I'd like to have a demonstration
- Send lit including sample of printout

Name _____

Company _____

Dept. _____

Address _____

City _____ State _____

Zip _____ Telephone _____

AXIOM AXIOM CORPORATION

5932 San Fernando Rd., Glendale, CA 91202 • (213) 245-9244 • TWX 910-497-2283

Circle 135 on reader service card

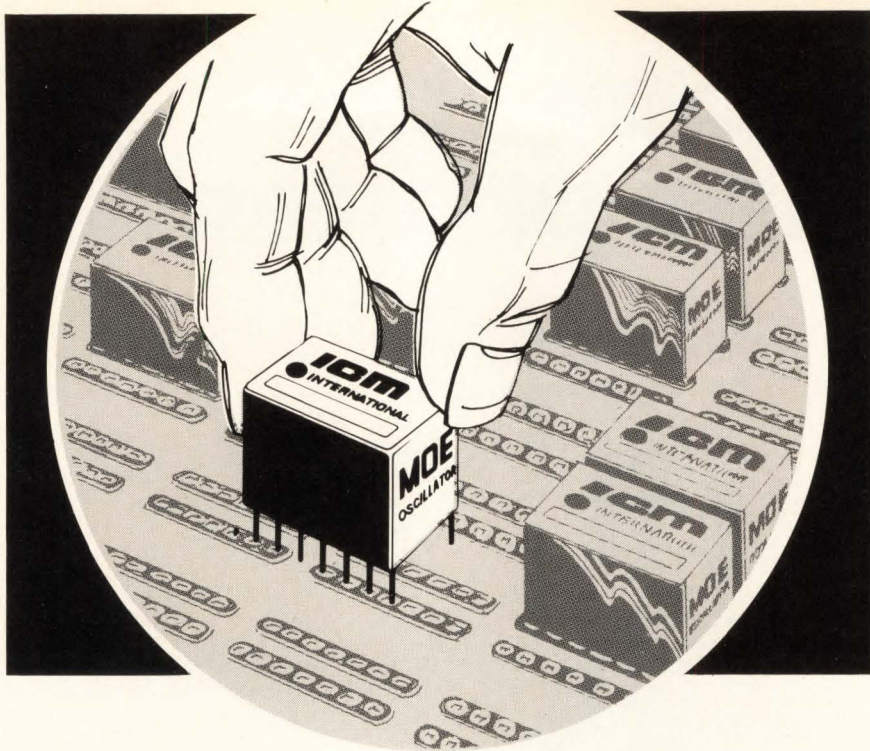

INTERNATIONAL'S
moe
**CRYSTAL OSCILLATOR
 ELEMENTS**

A Complete Controlled Signal Source from 6000 KHz to 60 MHz

The MOE series is designed for direct plug-in to a standard dip socket. The miniature oscillator element is a complete source, crystal controlled, in an integrated circuit 14 pin dual-in-line package with a height of 1/2 inch.

Oscillators are grouped by frequency and temperature stability thus giving the user a selection of the overall accuracy desired. Operating voltage 6 vdc. Output wave shape — non sine.

TYPE	CRYSTAL RANGE	OVERALL ACCURACY	25°C TOLERANCE	PRICE
MOE-5	6000KHz to 60MHz	+ .002% -10° to +60°C	Zero Trimmer	\$35.00
MOE-10	6000KHz to 60MHz	+ .0005% -10° to +60°C	Zero Trimmer	\$50.00

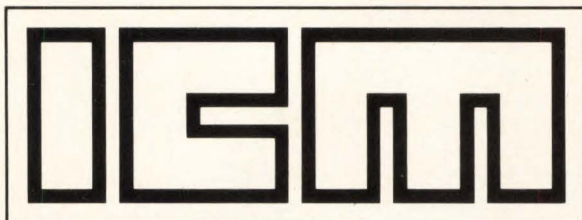

International Crystal Manufacturing Company, Inc.
 10 North Lee, Oklahoma City, Oklahoma 73102

New products

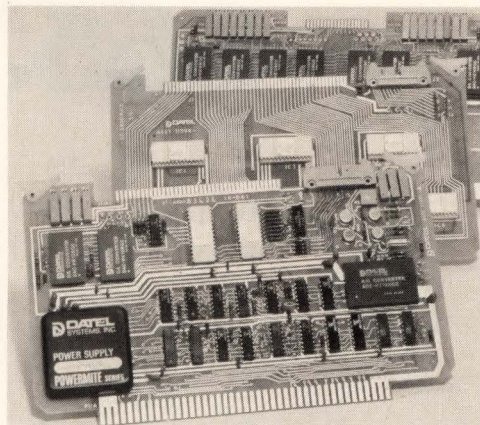

tion analog-to-digital converter with a throughput of 30 kilohertz.

On the output side, the 1081 delivers 12-bit current or voltage outputs that settle to within half a least significant bit in 10 microseconds. Maximum error is 0.125% of full-scale range.

Barry Glasgow, Analogic's marketing manager for Data Systems, says one of the most innovative features of the 1080/1081 is that the subsystems are interfaced to the microcomputer by both a communications register unit and memory-mapping. All control functions are driven by setting or clearing specific bits in the CRU interface.

"The operator can use any one of the memory reference instructions to initiate a conversion on a selected channel, gather the data, and operate on the data," Glasgow explains. For example, the instruction "multiply R₂, R₄" initiates the conversion, holds the processor until the conversion is done, and performs the required multiplication—all in one sequence, without resorting to any interrupt-handling routines. "This isn't a significant slowdown, and it's more efficient than an interrupt routine," Glasgow says, "essentially treating the a-d converter as read-only memory."

A 1080 with 16 single-ended channels is priced at \$660, with the price rising to \$789 for 64 channels. A single-channel 1081 sells for \$331, while four channels cost \$689. All prices are for quantities of six to nine.

Analogic Corp., Audubon Rd., Wakefield, Mass. 01880. Phone (617) 246-0300 [342]

KW-PAC

"COOL POWER"



HIGH VOLTAGE — HIGH CURRENT SILICON RECTIFIERS

KW-PAC is an economically priced, rugged and versatile family of silicon rectifiers. "Off-the-shelf" units can be assembled into any standard circuit and handles kilowatts to megawatts.

- Easy mounting and terminations
- More surface area for better cooling
- Can be used in air or oil
- 750V to 72,000 Volts
- 3.8 to 20 Amperes (55°C oil)

A 72KW driver power supply, built by Continental Electronics Manufacturing Co., Dallas, Texas, featuring three KW-PAC rectifiers.

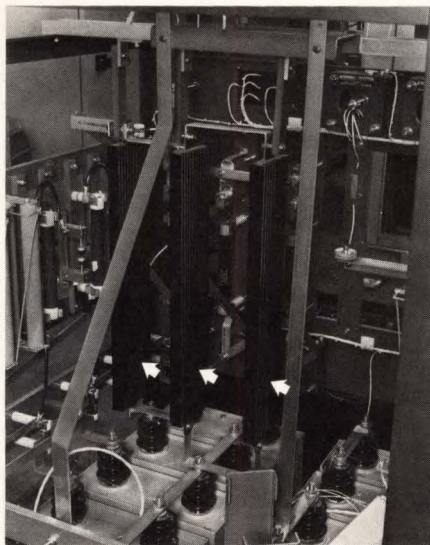

Available as half wave rectifiers, center taps and doublers. For special orders, "KW-PAC" can be provided with fast recovery characteristics or other factory specials.

1975 NATIONAL SBA SUBCONTRACTOR OF THE YEAR

 **SEMTECH**
CORPORATION

652 Mitchell Road, Newbury Park, California 91320
(805) 498-2111 • (213) 628-5392 • TWX: 910-336-1264
CHICAGO: (312) 352-3227 • DALLAS: (214) 234-6523
DAYTON: (513) 274-8356 • FLORIDA: (305) 644-5404
MARYLAND: (301) 937-0070 • NEW JERSEY: (201) 654-4884
SAN FRANCISCO: (415) 494-0113 • SEATTLE: (206) 455-4807
EUROPEAN SALES: Bourns AG Zug, Switzerland (042) 232-242

Nobody else has LSI-11 cards like these.

When it comes to I/O single board systems for the DEC LSI-11, ADAC has both digital and analog cards that simply aren't available anywhere else.

Take our digital cards for example. They are loaded with unique features such as the ability to use I/O lines as either inputs or outputs in increments of eight, up to 64 TTL inputs or outputs interfaced directly to the LSI-11 bus, the ability to detect contact closures on discrete input lines, and discrete latched outputs with the capability to drive high current incandescent lamps.

Our bus interface cards are also unique. The Bus Repeater Card is used to accommodate more devices than the basic bus can handle. The Bus Translator Card allows LSI-11 peripherals to operate with a Unibus CPU.

And let's not forget the first-of-their-kind analog cards. Both high level and low level are available with features like direct thermocouple digitizing, 250V CM isolation, six gain codes, up to 64 channels, and program control interface . . . to mention just a few.

Write or call for full details on the industry's widest line of LSI-11 Cards.



15 Cummings Park
Woburn, MA 01801
(617) 935-6668
Telex 949 329



More muscle for your microprocessor: Now there's a simpler way to trigger a triac, drive a digit, or light up a lamp.

One of our new addressable drivers can control up to eight peripheral devices in any bus-oriented system.

Next time you put a microprocessor to work, it may have more to manipulate than data. Real-world μ P applications often require the kind of muscle that our new NE590/591 Addressable Peripheral Drivers can provide—simpler and less expensively than the usual combination of discrete power transistors and resistors. **Another First From Signetics.** Either of these new devices can give you a powerful alternative way to address and drive as many as eight different peripherals, using bits extracted directly from a bus. Each of the 8 latched Darlington outputs can drive a 250-mA load current, subject to power dissipation limitations. That's plenty of muscle for turning on (or off) LEDs, SCRs, stepping motors and a host of other commonly used peripheral components.

Most applications can be handled by the 16-pin NE590, which has 8 open-collector (current sinking) outputs. The NE591 is an 18-pin version with open-emitter (current sourcing) outputs.

Simpler Designs at Lower Costs.

A quick parts count and cost evaluation will demonstrate the device's dollar savings. The NE590N costs only \$1.95 in

100 quantity, the NE591N, \$2.45. You can do the same job with an addressable latch, but you'll need extra driver transistors and resistors that will bring your total parts cost—exclusive of assembly, testing and related expenses—to a considerably higher price.

Use NE590 or NE591 whenever you have multiple high-current peripherals to drive in any bus-oriented system. You'll simplify your design, improve reliability, reduce component and assembly costs. In short, you'll get more muscle for your money.

Addressable Peripheral Drivers. Available only from Signetics. Call your nearest distributor or send the coupon to us today for your data sheet, a sample, or quick attention to any application questions you have.

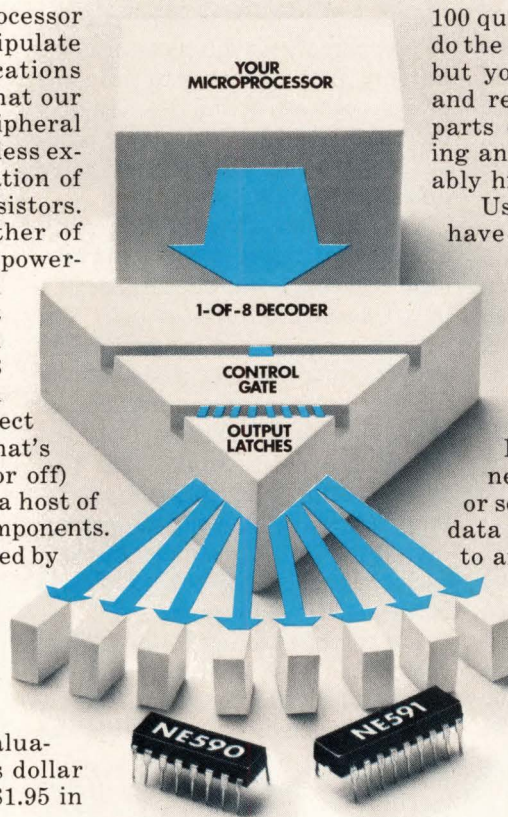

Signetics

a subsidiary of U.S. Philips Corporation

Signetics Corporation
811 East Arques Avenue
Sunnyvale, California 94086
Telephone 408/739-7700

OTHER SIGNETICS DRIVERS

Part No.	Description	Output Current	No. of Drivers
NE582	LED digit drivers	400mA	6
ULN2001 series	Power drivers	500mA	7
NE5501 series	High-voltage power drivers	500mA	7
DS3611 series	Peripheral drivers	300mA	2
UDN5711 series	Peripheral drivers	300mA	2

To: Signetics Information Services, 811 E. Arques Ave.
P.O. Box 9052, MS 27, Sunnyvale, CA 94086

- Send me your NE590/591 Data Sheet
 Send me a sample of the NE590 for evaluation.
 I need data on these other devices shown in the table:

- I have an urgent requirement. Please have an applications specialist phone me at once: () _____

Name _____ Title _____

Company _____ Division _____

Address _____ MS _____

City _____ State _____ Zip _____

(Note: For faster response, clip coupon to letterhead.) EM128

New products

Instruments

Logic analyzer has 32 channels

Unit, at home in lab or in the field, features signature-analysis capability

Logic analyzers continue to be simplified to allow them to be used by production-test and field-service personnel. Paratronics Inc., with its new model 532, says it has a logic analyzer that not only serves such needs but also retains its usefulness in the engineering lab. The unit is a 32-channel logic-state analyzer that, when used with an oscilloscope, can display up to 256 words, either in alphanumeric or binary formats. Among its other features are a signature-analysis capability for testing memory contents and new triggering modes. In addition, the San Jose, Calif., based company also has another analyzer, the model 150, specifically aimed at monitoring the S-100 bus, which is commonly used on many hobby computers.

The unit incorporates a calculator-type keyboard for entering the trigger word and selecting one of 21

triggering modes. The 532's 32-bit words can be split into two channels, each 16 bits wide, and separately clocked, making the unit compatible with 16-bit microprocessor chips. Basic speed of the analyzer is 5 MHz, with 12 MHz available as an option. In the signature-analysis mode, the analyzer's microprocessor compresses up to 8,000 bits stored in a memory into a 32-bit-wide signature and converts it into hexadecimal form for display. This signature can be compared with the signature of a memory that is known to have the proper contents. If the two disagree, there is a very high, calculable probability that the memories have different contents.

One unusual triggering scheme is a sequential mode, in which the analyzer will trigger the appearance of a preset sequential address pair. The user thus can instruct the analyzer to trigger either when a certain address follows another preset address or when the second address does not follow that first address. This feature is useful in investigating situations where the sequence of instructions is known. Any number of clock cycles or triggers can be set as delays between the two addresses.

For troubleshooting by less skilled personnel, the analyzer can be programmed with a programmable read-only memory plugged into the

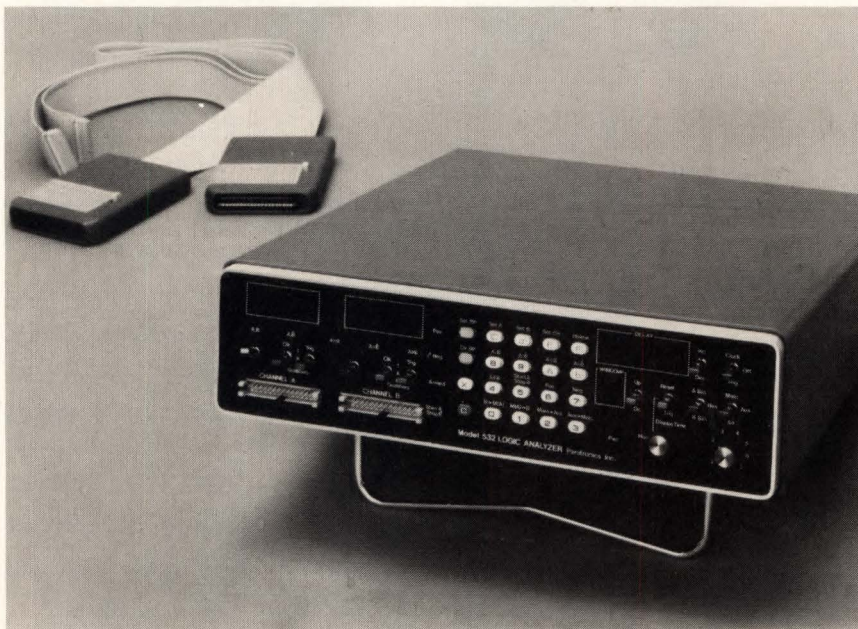

- ALABAMA:** Huntsville, Hall-Mark/Huntsville (205) 837-8700.
- ARIZONA:** Phoenix, Kierulff Electronics (602) 243-4101. R. V. Weatherford (602) 272-7144. Tempe, G. S. Marshall (602) 968-6181.
- CALIFORNIA:** Anaheim, R. V. Weatherford (714) 634-9600. Canoga Park, G. S. Marshall (213) 999-5001. El Monte, G. S. Marshall (213) 686-0141. El Segundo, TI Supply (213) 973-2571. Glendale, R. V. Weatherford (213) 849-3451. Goleta, RPS, Inc. (805) 964-6823. Irvine, Cramer/Los Angeles (714) 979-3000. (213) 771-8300. G. S. Marshall (714) 556-6400. Los Angeles, Kierulff Electronics (213) 685-5511. RPS, Inc. (213) 748-1271. Mountain View, Time Electronics (408) 965-8000. Palo Alto, Kierulff Electronics (415) 968-6292. Pomona, R. V. Weatherford (714) 623-1261. San Diego, Cramer/San Diego (714) 565-1881. Kierulff Electronics (714) 278-2112. G. S. Marshall (714) 278-6350. RPS Inc. (714) 292-5611. R. V. Weatherford (714) 278-7400. Sunnyvale, Cramer/San Francisco (408) 739-3011. G. S. Marshall (408) 732-1100. TI Supply (408) 732-5555. Torrance, Time Electronics (213) 320-0880. Tustin, Kierulff Electronics (714) 731-5711. Woodland Hills, JACO (213) 884-4560.
- COLORADO:** Denver, Cramer/Denver (303) 758-2100. Kierulff Electronics (303) 371-6500. Englewood, R. V. Weatherford (303) 761-5432.
- CONNECTICUT:** Hamden, Arrow Electronics (203) 248-3801. TI Supply (203) 281-4669. North Haven, Cramer/Connecticut (203) 239-5641. Orange, Milgray/Connecticut (203) 795-0714.
- FLORIDA:** Clearwater, Diplomat/Southland (813) 443-4514. Ft. Lauderdale, Arrow Electronics (305) 776-7790. Hall-Mark/Miami (305) 971-9280. Hollywood, Cramer/Hollywood (305) 921-7878. Orlando, Cramer/Orlando (305) 894-1511. Hall-Mark/Orlando (305) 855-4020. Winter Park, Milgray Electronics (305) 647-5747.
- GEORGIA:** Doraville, Arrow Electronics (404) 455-4054. Norcross, Cramer/Atlanta (404) 448-9050.
- ILLINOIS:** Arlington Heights, TI Supply (312) 640-2964. Elk Grove, Hall-Mark/Chicago (312) 437-8800. Kierulff Electronics (312) 640-0200. Chicago, Newark Electronics (312) 638-4411. Mt. Prospect, Cramer/Chicago (312) 593-8230.
- INDIANA:** Ft. Wayne, Ft. Wayne Electronics (219) 423-3422. Indianapolis, Graham Electronics (317) 634-8202.
- IOWA:** Cedar Rapids, Deeco (319) 365-7551.
- KANSAS:** Shawnee Mission, Hall-Mark/Kansas City (913) 888-4747.
- MASSACHUSETTS:** Billerica, Kierulff Electronics (617) 667-8331. Newton, Cramer/Newton (617) 969-7700. Waltham, TI Supply (617) 890-0510. Woburn, Arrow Electronics (617) 933-8130.
- MARYLAND:** Baltimore, Arrow Electronics (202) 737-1700. (301) 247-5200. Hall-Mark/Baltimore (301) 796-9300. Columbia, Technico (301) 461-2200. Gaithersburg, Cramer/Washington (301) 948-0110. Kierulff Electronics (301) 948-0250. Hyattsville, Milgray/Washington (301) 459-2222.
- MICHIGAN:** Ann Arbor, Arrow Electronics (313) 971-8220. Detroit, Newark Electronics (313) 967-0600. Grand Rapids, Newark Electronics (616) 241-6681.
- MINNESOTA:** Bloomington, Arrow Electronics (612) 887-6400. Edina, Cramer/Minnesota (612) 835-7811.
- MISSOURI:** Earth City, Hall-Mark/St. Louis (314) 291-5350. Kansas City, LCOMP-Kansas City (816) 221-2400. St. Louis, LCOMP-St. Louis (314) 291-6200.
- NEW HAMPSHIRE:** Manchester, Arrow Electronics (603) 668-6968.
- NEW JERSEY:** Camden, General Radio Supply (609) 964-8560. Cherry Hill, Cramer/Pennsylvania (215) 923-5950. (609) 424-5993. Milgray/Delaware Valley (609) 424-1300. (215) 228-2000. Clark, TI Supply (201) 382-8400. Clifton, Wilshire Electronics (201) 340-1900. Little Falls, Cramer/New Jersey (201) 785-4300. Moorestown, Arrow Electronics (609) 235-9000. Rutherford, Kierulff Electronics (201) 935-2120. Saddlebrook, Arrow Electronics (201) 797-5800.
- NEW MEXICO:** Albuquerque, Cramer/New Mexico (505) 243-4568. International Electronics (505) 265-6453.
- NEW YORK:** East Syracuse, Cramer/Syracuse (315) 437-6671. Endwell, Wilshire Electronics (607) 754-1570. Farmingdale, Arrow Electronics (516) 834-6800. Hicksville, Kierulff Electronics (516) 433-5530. Fishkill, Arrow Electronics (914) 896-7530. Freeport, Milgray Electronics (516) 546-6000. N.J. (800) 645-3986. Hauppauge, Cramer/Long Island (516) 231-5600. JACO (516) 273-1234. Rochester, Cramer/Rochester (716) 275-0300. Rochester Radio Supply (716) 454-7800. Wilshire Electronics (716) 442-9560.
- NORTH CAROLINA:** Raleigh, Hall-Mark/Raleigh (919) 832-4465. Winston-Salem, Cramer/Winston-Salem (919) 725-8711.
- OHIO:** Cleveland, Arrow Electronics (216) 464-2000. Cramer/Cleveland (216) 248-8400. Columbus, Hall-Mark/Ohio (614) 846-1882. Dayton, ESCO Electronics (513) 226-1133. Kettering, Arrow Electronics (513) 253-9176.
- OKLAHOMA:** Tulsa, Hall-Mark/Tulsa (918) 835-8458. TI Supply (918) 582-8272.
- PENNSYLVANIA:** Huntingdon Valley, Hall-Mark/Philadelphia (215) 355-7300.
- TEXAS:** Austin, Hall-Mark/Austin (512) 837-2814. Dallas, Hall-Mark/Dallas (214) 234-7400. TI Supply (214) 238-6821. El Paso, International Electronics, (915) 778-9761. Houston, Hall-Mark/Houston (713) 781-6100. Harrison Equipment (713) 652-4700. TI Supply (713) 776-6511. R. V. Weatherford (713) 688-7406.
- UTAH:** Salt Lake City, Diplomat/Altalad (801) 486-4134. Standard Supply (801) 486-3371.
- VIRGINIA:** Roanoke, Technico (703) 563-4975.
- WASHINGTON:** Seattle, Almac/Stroum Electronics (206) 763-2300. Cramer/Seattle (206) 575-0907. Kierulff Electronics (206) 575-4420.
- WISCONSIN:** Brookfield, Newark Electronics (414) 781-2450. Oak Creek, Arrow Electronics (414) 764-6600. West Allis, Hall-Mark/Milwaukee (414) 476-1270.
- CANADA:** Calgary, Cam Gard Supply (403) 287-0520. Downsview, CESCO Electronics (416) 661-0220. Zentrionics (416) 635-2822. Edmonton, Cam Gard Supply (403) 426-1805. Halifax, Cam Gard Supply (902) 454-8581. Kamloops, Cam Gard Supply (604) 372-3338. Moncton, Cam Gard Supply (506) 855-2200. Montreal, CESCO Electronics (514) 735-5511. Future Electronics (514) 735-5775. Zentrionics (514) 735-5361. Ottawa, CESCO Electronics (613) 729-6411. Quebec City, CESCO Electronics (418) 524-4641. Regina, Cam Gard Supply (306) 525-1317. Rexdale, Future Electronics (416) 677-7820. Saskatoon, Cam Gard Supply (306) 652-6424. Vancouver, Cam Gard Supply (604) 291-1441. Winnipeg, Cam Gard Supply (204) 786-8481.

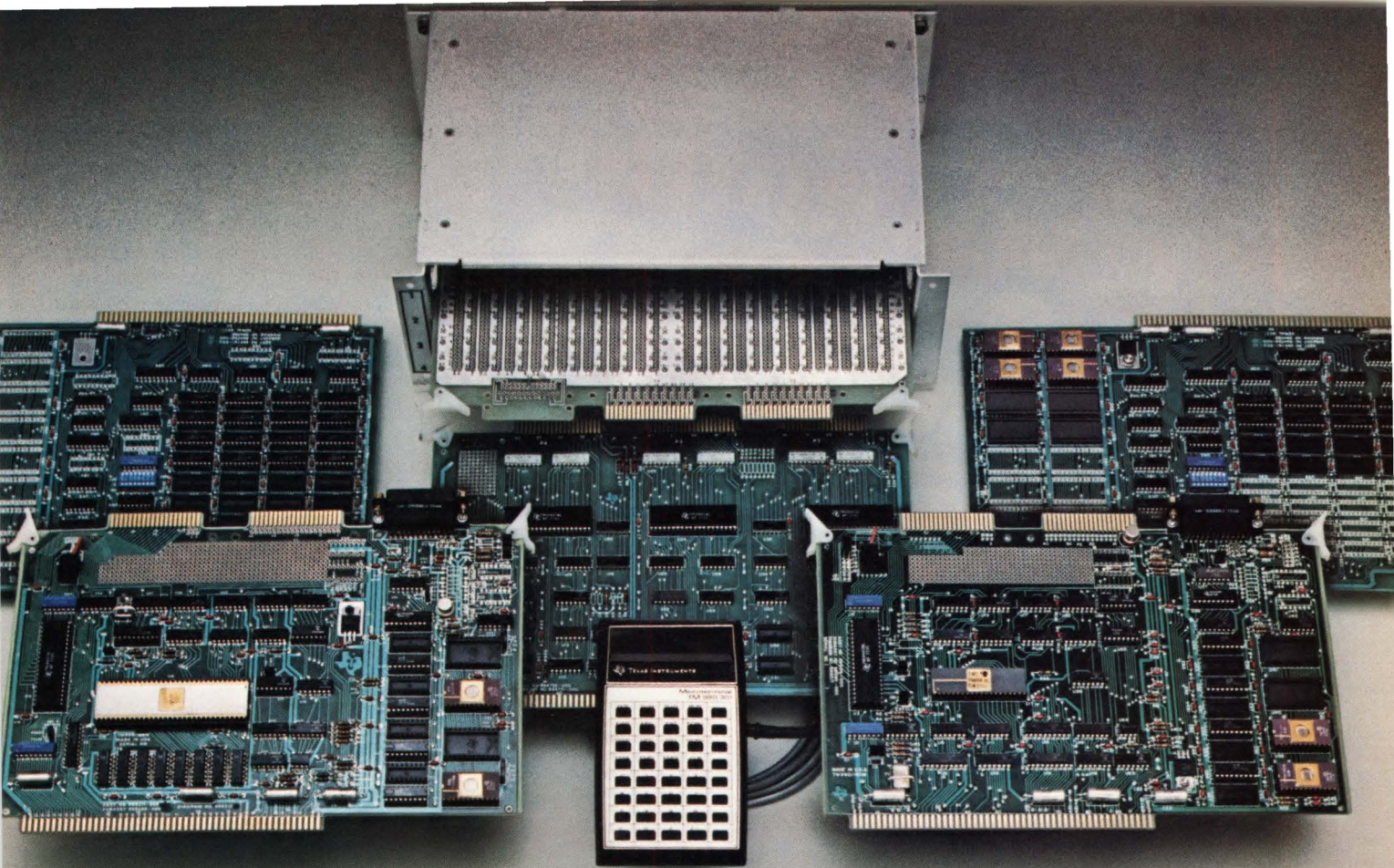

9900 FAMILY

Now—more OEM μ P modules from TI: 16-bit performance at 8-bit prices.

Compare TI's series of TM 990 microcomputer modules. Here's 16-bit performance at a cost less than 8 bits.

And 16-bit performance means increased throughput. Programming ease. Improved memory efficiency. All leading to greater system savings.

Use these new modules for μ P evaluation. And as a production alternative. To speed your microprocessor-based design to market. To minimize design costs.

Leadership series

Included in the TM 990 Series are:

- TM 990/100M – TI's TMS 9900 μ P, I/O circuits, and memory—all on a single board. \$450.00*.
- TM 990/180M – 16-bit TMS 9980 μ P offers 2 MHz operation with 8-bit data bus. \$435.00*.

- TM 990/201 – Memory expansion board: 8K bytes of EPROM, 4K bytes of static RAM. Expandable to 32K bytes of EPROM and 16K bytes of RAM. \$595.00*.

- TM 990/206 – Memory expansion board with 8K bytes of RAM. Expandable to 16K bytes. \$585.00*.

- TM 990/301 – Microterminal for data entry and display. \$125.00*.

- TM 990/310 – a 48-bit input/output expansion module. \$295.00*.

- TM 990/401 – Interactive debug monitor (TIBUG™) preprogrammed into CPU EPROM. \$100.00*.

- TM 990/402 – Line-by-line assembler preprogrammed into the EPROM. \$100.00*.

- TM 990/510 – Four-slot OEM chassis on 1" spacing. \$190.00*.

- Cables, connectors, extender and prototyping boards are also available.

And even more modules will be available soon.

All are preassembled. Pretested. Ready to go. Supported by easy-to-use software.

9900 First Family compatibility.

The TM 990 modules are also supported by the advanced AMPL™ software development system. And all are instruction-set compatible with other members of TI's 9900 First Family.

For more details, call your authorized TI distributor. Or write Texas Instruments Incorporated, P. O. Box 1443, M/S 653, Houston, Texas 77001.

*One to nine quantity



TEXAS INSTRUMENTS
INCORPORATED

THE NEW ROTRON[®] MAJOR

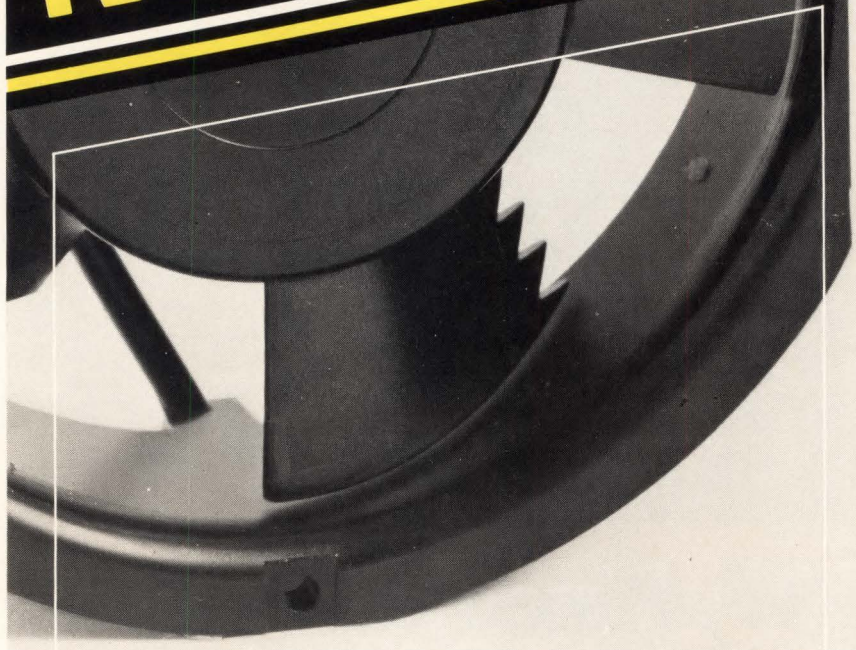

One more proof... Rotron has a way with air.

The news is noise . . . the lack of it. Because the *new* Major tubeaxial fan gives the same performance as its popular predecessor, with even less noise than before under typical operating conditions. (150 cfm at .35" H₂O).

- with exclusive Feathered Edge™ blade design—for acoustical ratings as low as NC-53
- compact package—6.75" x 5.9" x 2"—flatted sides permit space saving array
- by the company that has brought you more new developments in precision air moving than all other companies combined.

See if it isn't time for a Major decision on your part. Call or write for the information you need on the new Rotron Major today.



ROTRON INC.
AN EG&G COMPANY

Woodstock, N. Y. 12498 □ 914 • 679-2401 □ TWX 510-247-9033
Garden Grove, Cal. 92641 • 714•898-5649 • Rotron B.V. Breda, Netherlands, Tel: (076)879311, Telex: NL 54074

New products

internal bus, which sets up seven preprogrammed tests. The analyzer sets up the triggering mechanism, collects the data, compares the results with the stored results, and displays the differences on the scope's cathode-ray tube. For production tests, the analyzer can be interfaced with the IEEE-488 interface bus to allow it to be operated remotely. It can produce hard copy of the test results through an RS-232 interface.

The model 150 is packaged on a single printed-circuit board and plugged directly into the computer bus. It can therefore analyze bus transactions without the need for connecting the 56 probes corresponding to the bus width. As an option, a ribbon-probe assembly is available to allow monitoring of up to eight user-defined signals.

Price of the 532 is \$1,500; an extra memory module and interface modules each add \$150 to \$250 to the basic price. Price of the model 150 is \$449 in assembled form and \$369 in kit form. The optional 8-bit probe is \$9.95.

Paratronics Inc., 800 Charcot Ave., San Jose, Calif. 95131 [351]

Logic-state analyzer also makes timing measurements

The model 1615A logic analyzer is a versatile instrument that can capture timing and logic-state information simultaneously. Those capabilities, along with its glitch-detection circuitry, allow the 20-MHZ unit to make all functional measurements on most logic circuits.

The 1615A can be configured in three ways with simple keyboard programming: as a 24-bit state analyzer, as an 8-bit timing analyz-



We say they're the industry standards. And the 118,723 people who've bought them will back us up.

The Fluke 8000A, 8600A and 8800A digital multimeters. Far and away the industry leaders, both in sales and performance.

They're why Fluke is #1 in multimeters. Worldwide.

8000A 3½ digit DMM. More people use the 8000A than any other DMM ever built. And there are good reasons. Specifications are guaranteed for 1 year for 5 measurement functions in 26 ranges. Input overload protection on all ranges. Basic accuracy is 0.1%. MTBF is 21,000 hours. And the 8000A comes in many versions: high current, low-ohms, with analog meter, or milliamperesecond. Base price \$299.*

8600A 4½ digit DMM. The 8600A is the prestige DMM in the portable class, featuring high accuracy and full auto-ranging.

Five ranges each of ac and dc volts to 1200V with 0.02% dc and 0.2% ac accuracy. Five ranges each of ac and dc current to 2A with 0.1% dc and 0.3% ac accuracy. Six ranges of resistance to 20 MΩ with 0.1% accuracy. AC bandwidth to 100 kHz. And demonstrated 10,000-hr MTBF. \$549*

8800A 5½ digit DMM. The 8800A is a unique portable, laboratory standard digital multimeter. It has, for example, a dc accuracy of 0.005%. Full autoranging. And it's fully guarded. Zero stability is better than 10 μV for 90 days. Isolated 4 terminal ohms. A demonstrated MTBF of 10,000 hours. \$985.*

So now you have a rough idea of why the 8000A, 8600A and 8800A DMMs are the industry standards.

But to really find out how good they are, ask almost anyone nearby. He's probably using one of our DMMs right now.

And he'll be able to tell you why Fluke is #1 in DMMs. Worldwide.

For data out today, dial our toll-free hotline, 800-426-0361. John Fluke Mfg. Co., Inc., P.O. Box 43210, Mountlake Terrace, WA 98043. Fluke (Nederland) B.V., P.O. Box 5053, Tilburg, The Netherlands. Phone: (013) 673-973. Telex: 52237.

*U.S. price only.

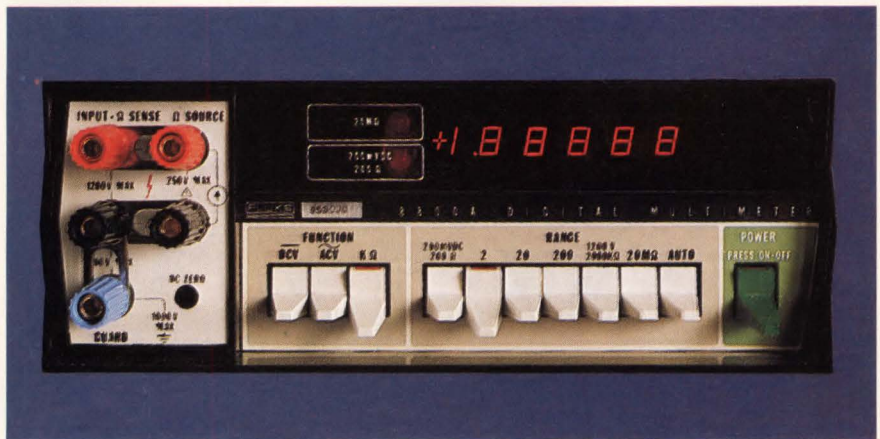
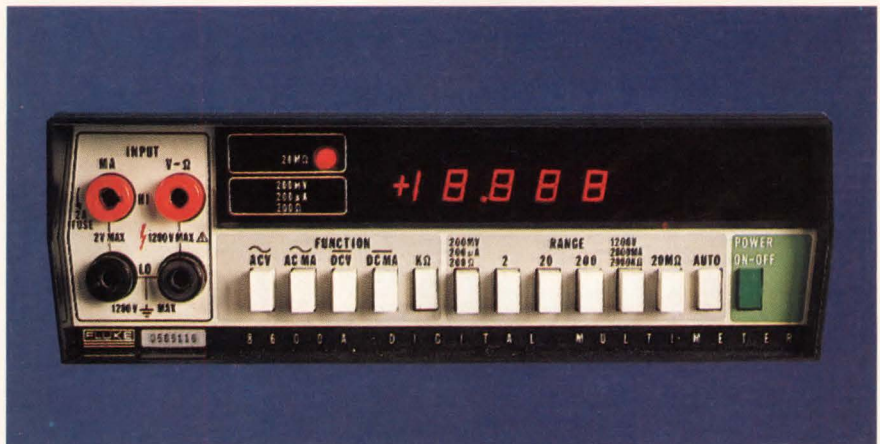
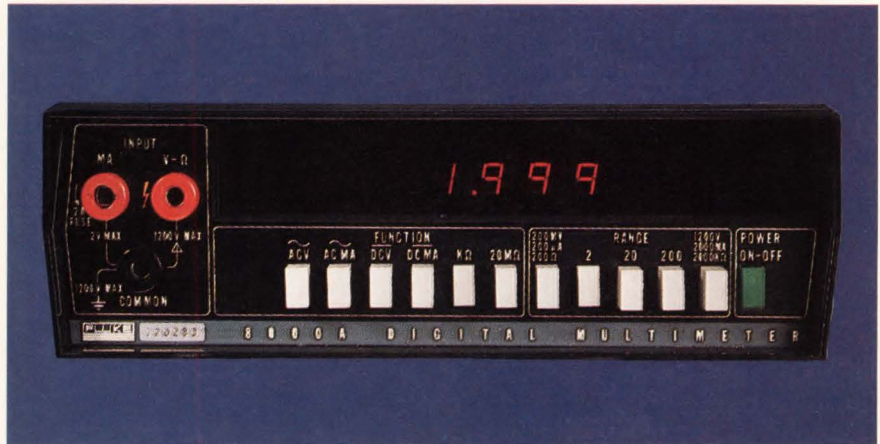

Fluke DMMs. Standards for the industry.



LOW FREQUENCY QUARTZ CRYSTALS



We have 1KHz to 1MHz quartz crystals for your low-frequency applications. McCoy's quartz crystals feature technology in controlling TC and motional parameters, performance with a five to six week lead time, and quality design and process controls. Our outstanding line of low-frequency quartz crystals includes: JT, NT, 5°XF, 5°X, MT, GT, BD, DT, CT, and SL.

McCoy
ELECTRONICS COMPANY
a subsidiary of OAK Industries Inc.

MT, HOLLY SPRINGS, PA 17065 • TEL: 717-486-3411 • TWX: 510-650-3548

Circle 144 on reader service card

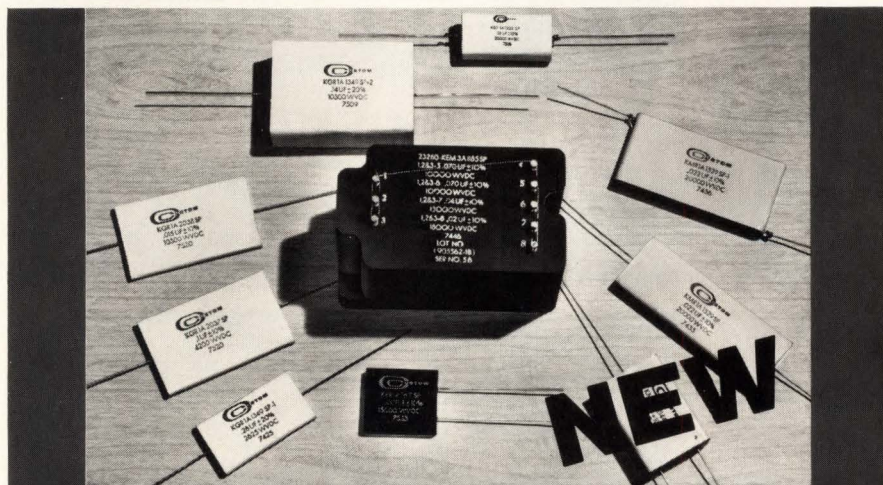

CUSTOM K SERIES MICA CAPACITORS

Maximum Energy in Compact Packages

The new K Series, developed for high reliability, is manufactured with mica paper dielectric impregnated with an epoxy formulation to produce a tough, long life capacitor.

KGR and KMR (wrap & fill), KER (fiberglass housed), and KEM (epoxy molded) models are available in solder type, threaded stud, or wire lead terminations. Mountings can be threaded studs, threaded inserts, or brackets.

Write for FREE K Series Techni Tip, and general Techni Tip including sample mica dielectric, to see how Custom Electronics can fill your requirements.

Send for FREE Product Brochure



Custom Electronics, Inc.
12 Browne Street, Oneonta, N.Y. 13820
Ph: (607) 432-3880 TWX: 510-241-8292

New products

er, or as a combined 16-bit state analyzer and 8-bit timing analyzer. In all three cases, the memory is 256 words deep.

In the timing mode, glitches are detected and captured, but displayed only if desired. The analyzer will detect glitches greater than 5 nanoseconds in duration and, because it can distinguish them from data, can use them as part of a trigger specification. Among its other triggering features are a 6-bit clock qualifier that allows selection of such specific data as all reads, all writes, and all I/O transactions.

The 1615A sells for \$6,800. It will be available in January.

Inquiries Manager, Hewlett-Packard Co., 1507 Page Mill Rd., Palo Alto, Calif. 94304 [353]

Data Tech introduces ac and dc digital panel meters

Data Tech has added three new units to its line of digital panel meters. The model 73 is an inexpensive 3½-digit dc meter with a light-emitting-diode display and a large-quantity price of \$39. Errors are within 0.05% of reading ± 1 count, and the temperature coefficient of error is 50 ppm/°C.

The model 83 (shown) is a 3½-digit meter that covers the frequency range from 35 Hz to 10 kHz with a maximum error of 0.2% of reading ± 1 count and a temperature coefficient of error of 90 ppm/°C. A 4½ digit version, the model 84, covers the same range with a basic error specification of 0.16% and a temperature coefficient of error of 50



After you look at the specs, look how long they're guaranteed.

The accuracy specs for the Dana 5100 5½ digit multimeter are guaranteed for a full year. Not 90 days. Not 6 months. That means you only have to calibrate it once a year.

All other multimeters have to be calibrated an average of three times a year. At about \$75 a pop. Which makes their \$995 units a lot more expensive to own than the Dana 5100 at \$1145*.

Instead of sitting in the shop for six weeks over the course of the year, the Dana 5100 will stay right where you are. Measuring AC, DC, Ohms and *frequency*

(yes, frequency too) with very high accuracy. Just like the specs say. For a year at a time.

When you look at it that way, one thing becomes obvious. The cost of owning a multimeter is a lot more important than the price.

Write Dana Laboratories, Inc., 2401 Campus Dr., Irvine, CA 92715 for all the specs. And take a good look. With specs that good, you'll be glad you only have to give it up once a year.

DANA®

Others measure by us.

*U.S. domestic prices.



Dana 5100.
Ask for a free demonstration
before you consider anything less.

C&K's Pushbutton Switches with Snap-in Bezels make the screwdriver obsolete.

specify
8161J82ZQ



specify
8125J81ZB

specify
8268J82ZQ

specify
8221J81ZB

C&K has four unique submini pushbutton switches with snap-in bezels that make a screwdriver unnecessary in panel assembly. These time-and-money saving switches simply snap into a panel hole and a nickel-plated steel mounting spring holds the switch firmly in place. The switches are available in 1-amp and 6-amp models in SPDT and DPDT configurations. Also .4VA for low energy circuits. LED illumination is available on certain models. For specifics, write or call today. With these new switches, the next time you pick up a screwdriver will be in your local tavern.

C&K Components, Inc., 103 Morse Street, Watertown, MA 02172 Tel: (617) 926-0800 TWX: 710-327-0460 TELEX: 92 2546
Free Engineering Sample on Request.

Circle 146 on reader service card



- **Fast TurnAround**
25 days from your design to prototype circuits
- **Low Cost**
Save 80% over a fully custom design
- **Reduced Circuit Size**
Multiple saving by reducing circuit size 90%
- **Proven Process**
Standard CMOS assures high reliability and dependable delivery

**INTERNATIONAL
MICROCIRCUITS, INC.**

3004 Lawrence Expwy., Santa Clara, Ca. 95050 (408) 735-9370

New products

ppm/°C. While introducing its new products, Data Tech announced that its entire 5313 DPM series has been awarded component recognition by Underwriters Laboratories.

Data Tech Division, Penril Corp., 2700 South Fairview St., Santa Ana, Calif. 92704. Phone (714) 546-7160 [354]

Amplifier converts voltage to current

The model 85 ac-dc voltage-to-current amplifier, given a nominal 1-v input, will deliver currents from 100 μ A to 10 A, selectable in decade ranges. Maximum dc error is 0.01% of output +0.02% of range. Maximum ac error (to 5 kHz) is 0.05% of output +0.05% of range. Output compliance is ± 10 v dc or peak ac to 1 A and ± 7 v dc or peak ac to



10 A. The model 85 sells for approximately \$2,095.

RFL Industries Inc., Boonton, N. J. 07005. Phone Robert Schmehl at (201) 334-3100 [355]

TOPICS

Instruments

Comstron Corp., Freeport, N. Y., has introduced an IEEE-488 interface bus option (Option 003) for its low-cost, five-digit, model 1013 frequency synthesizer. The option adds \$695 to the synthesizer's basic price of \$1,795. . . . **Ailtech, Farmingdale, N. Y.**, is also offering an IEEE-488 interface bus option for one of its instruments—the model 7370 system noise monitor. The option costs \$875. . . . **West-on Instruments, Newark, N. J.**, was recently awarded Underwriters Laboratories recognition for its 2460 series of ac-powered digital panel meters.

Ready for automatic insertion?

Our Radial Capacitors are

That's right. Our radial leaded ceramic capacitors — both disc and monolithic — are now available in reel packaging for your automatic insertion equipment. That means whichever type you need, you can now use the most efficient production method for lowest installed cost. For price, delivery, and technical information, contact Centralab, El Paso about the discs, and Centralab, Los Angeles about the MonoKaps™.

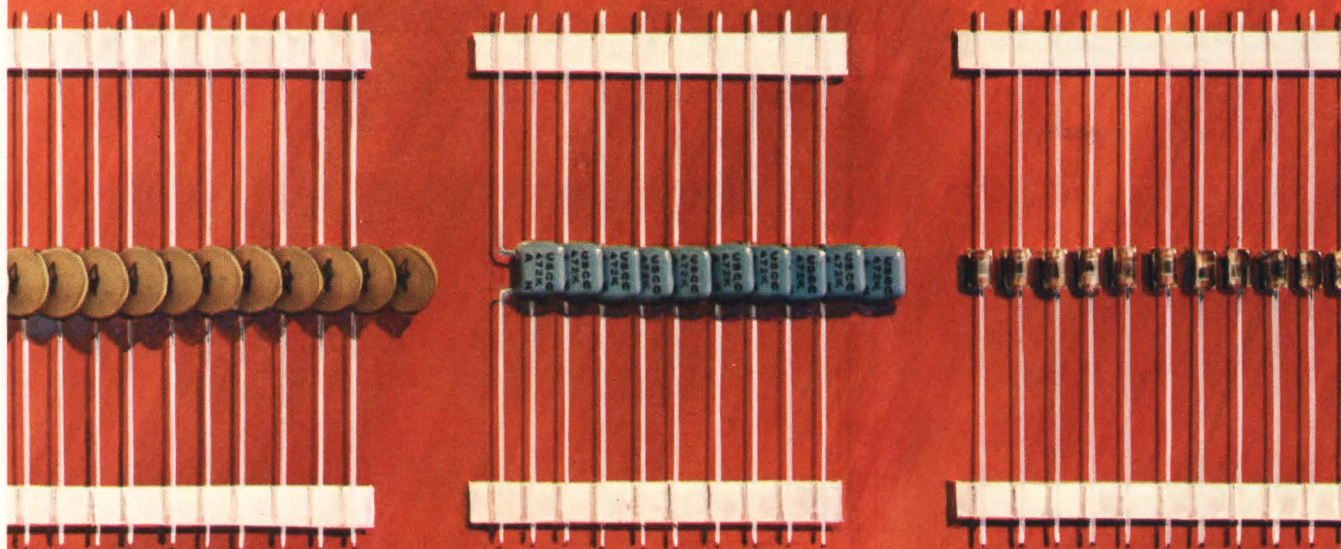

So are our Axial Capacitors

If board space and weight are your critical concerns, consider our miniature Mono-Glass ceramic capacitors. Also reel packaged for automatic insertion, they feature glass encapsulated construction in an axial leaded configuration, and a variety of dielectrics, in both precious and base metal electrodes. Contact Centralab, Los Angeles for complete price and delivery information.



CENTRALAB
Electronics • GLOBE-UNION INC.

4561 Colorado Blvd., Los Angeles, CA 90039 (213) 240-4880
7158 Merchant Ave., El Paso, TX 79915 (915) 779-3961

CERAMIC CAPACITORS • FILTERS • POTENTIOMETERS • SWITCHES
THICK FILM CIRCUITS • TRIMMER RESISTORS

CADNICA[®]

POWER!



Nickel-Cadmium Rechargeable Batteries for O.E.M. Applications

From the advanced technology of one of the world's largest battery manufacturers... CADNICA Nickel-Cadmium batteries that set new standards of performance and economy for O.E.M. applications.

Sealed CADNICA batteries withstand overcharge and overdischarge, and provide reliable service over hundreds of charge/discharge cycles. They're the

perfect power source for cordless products like tape recorders... radios... calculators... shavers... flashlights... toys... portable power tools... smoke detectors... computers... security products.

Call Sanyo... for speedy shipment from inventory... or for a power source designed to meet your special need.



SANYO

The better life.

SANYO ELECTRIC INC. • 51 Joseph St., Moonachie, N.J. 07074 • (201) 641-2333
 Battery Division, (Dept. E) • 1200 W. Artesia Blvd., Compton, Cal. 90220 • (213) 537-5830

Here's why you should rent your electronic test equipment from us...

You'll get action—When we tell you you'll get your equipment when you need it, it'll be there. Calibrated and ready to go.

You can count on our people—They're specialists, trained to help you find the most effective solution to application problems.

You'll have a much larger selection—We have the largest electronic test equipment inventory in the nation. Over 17,000 pieces.

You'll find us nearby—We have Electro Rent inventory/service centers and representatives near every major city in the nation.

So call toll-free 800-423-2337 now!
(In California: 800-232-2173)

Or write our Marketing Manager at: 4131 Vanowen Place, Burbank, CA 91505 for a FREE CATALOG. **Contact our Equipment Sales Division if you are interested in buying quality used equipment.**

R
ElectroRent
A Telecor Company

G.S.A. Contract #GS-04S-21907

Circle 149 on reader service card

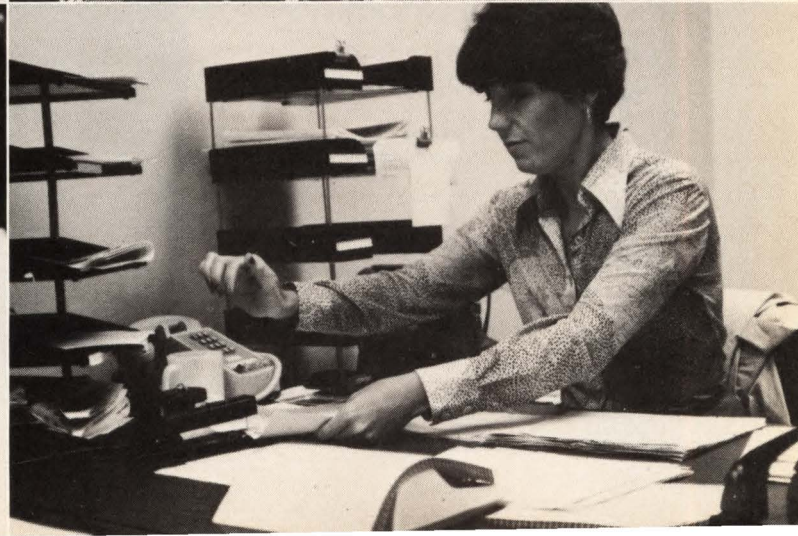
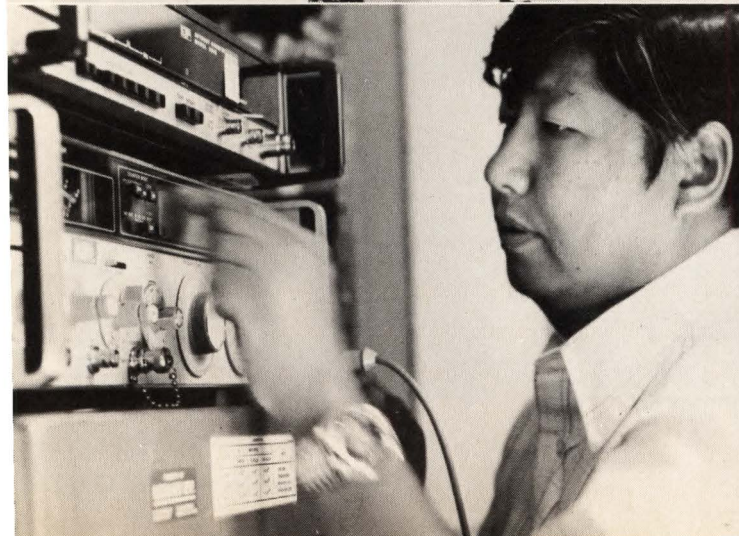

Electronics Magazine Book Series. Zero-risk trial offer.

1. Microprocessors

What you must know about available microprocessor technology, devices, information. 4th printing. \$8.95



2. Applying Microprocessors

2nd and 3rd generation technology. 26 detailed applications from data networks to video games. \$9.95

3. Large Scale Integration
Covers the basic technology, new LSI devices, LSI testing procedures, plus system design and applications. \$9.95

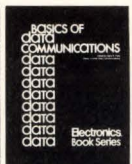

4. Basics of Data Communications

Includes 47 articles from Data Communications magazine covering more than 11 key areas. \$12.95.

5. Circuits for Electronics Engineers

Contains 306 circuits arranged by 51 functions from Amplifiers to Voltage Regulating Circuits. Saves design drudgery. \$15.95



Electronics Book Series
P.O. Box 669, Hightstown, N.J. 08520

1. Send me _____ copies of "Microprocessors" at \$8.95 per copy.
2. Send me _____ copies of "Applying Microprocessors" at \$9.95 per copy.
3. Send me _____ copies of "Large Scale Integration" at \$9.95 per copy.
4. Send me _____ copies of "Basics of Data Communications" at \$12.50 per copy.
5. Send me _____ copies of "Circuits for Electronics Engineers" at \$15.95 per copy.

Discounts of 40% on orders of 10 or more copies. I must be fully satisfied or you will refund full payment if the book is returned after ten-day trial examination.

Payment enclosed Bill firm Bill me
Charge to my credit card:
 American Express Diners Club
 BankAmericard Master Charge

Acc't No. _____

Date exp. _____

On Master Charge only,
first numbers above name _____

Name _____ Title _____

Company _____

Street _____

City _____ State _____ Zip _____

Signature _____

New products

Semiconductors

Data-acquisition system fits on a single chip

By putting all of the components into a single monolithic circuit, National Semiconductor Corp. has reduced the cost and raised the reliability of data-acquisition systems. The company has used a high-density, ion-implanted, metal-oxide-semiconductor process to produce a single 28,000-square-mil complementary-MOS chip that includes an 8-bit analog-to-digital converter, three-state latched outputs and a 16-channel expandable multiplexer with address input latches.

The new 5-v single-supply device, called ADC0816, costs \$19.95 in quantities of 100 or more and can replace \$100 to \$200 worth of hybrid and discrete-component analog boards. Housed in a 40-pin dual in-line package, it can perform a conversion in 114 microseconds and is ideal for applications such as medical instruments, process control, and machine control.

At 25°C, the system's linearity, zero error, and full-scale error are no more than 1/2 least significant bit each. The sum of total unadjusted error and quan-

tization error is guaranteed to be less than 1 LSB. Over the temperature range of -40°C to 85°C, the sum will not exceed 1 1/4 LSB.

In addition to other benefits, the company points out that having a data-acquisition system on one chip removes the need for multichip interfacing and reduces compatibility problems. Easy interfacing with microprocessors is provided by latched and decoded inputs and latched transistor-transistor-logic outputs. The ADC0816 consumes only 15 milliwatts by using micropower analog C-MOS circuitry.

The heart of the single-chip system is its 8-bit a-d converter, partitioned into three main sections: a 256-step resistor ladder network, a chopper-stabilized comparator, and a successive-approximation register. The system can perform without external components in ratiometric-sensing applications and therefore operates without an external voltage reference. For applications that require an absolute measurement, a standard, commercially available voltage reference must, of course, be used with the ADC0816.

The single-chip data-acquisition system is being produced in two versions—the ADC0816 with absolute accuracy to within 1 LSB at 25°C, and the ADC0817 with an absolute accuracy to within 1 1/2 LSB. The systems are priced at \$19.75 and \$17.95, respectively, in

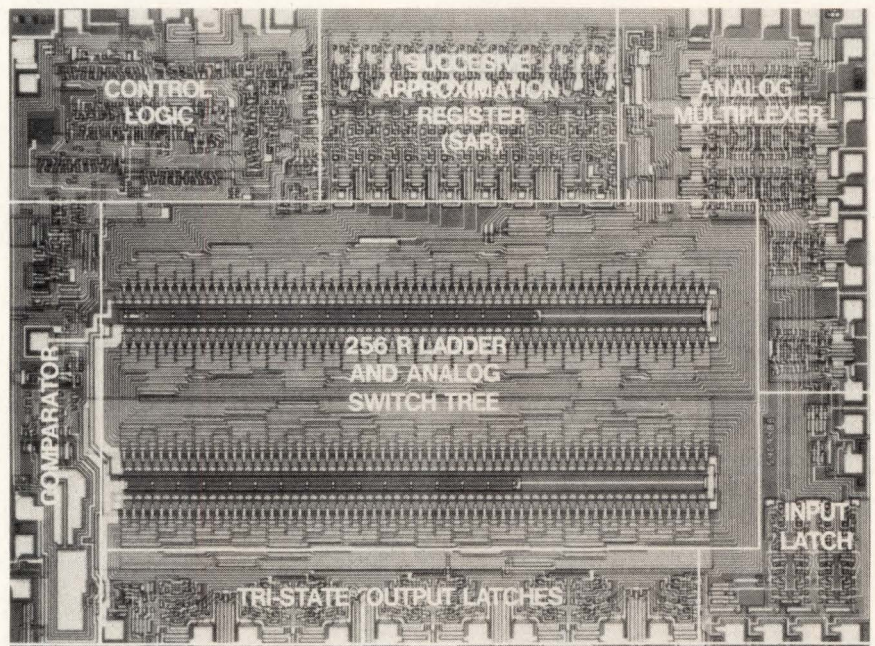

FOR THE RECORD:

The difference in HP's lowest price XY recorder is that you get full capability in the bargain.

When you look for an economical lab XY recorder, remember that certain things shouldn't be sacrificed at any cost. That's the way we build our lowest price XY.

Designed around HP's rugged one-piece casting, our Model 7015B gives you full capability without adding extra cost options.

Internal time base lets you make recordings vs. time without an external ramp generator. Matched input filters virtually eliminate troublesome noise in the trace. Remote pen lift permits precision timing for blemish-free rapid work by external command. And by accepting TTL or low current contact closures, the 7015B lets you interface easily with other equipment.

It's engineered to meet HP's own tough environmental specifications. Even the continuous duty servo motors are built to take plenty of punishment.

At \$1325 (domestic USA price), HP asks a little more for its lowest price XY recorder. The difference to you is full capability and rugged construction. And that's what we call a bargain.

11802

FOR THE RECORD, HP MAKES A DIFFERENCE

HEWLETT  PACKARD

1507 Page Mill Road, Palo Alto, California 94304

For assistance call: Washington (301) 948-6370, Chicago (312) 255-9800, Atlanta (404) 955-1500, Los Angeles (213) 877-1282

Get hold of the new TO-220 Triac, SCR from Hutson.

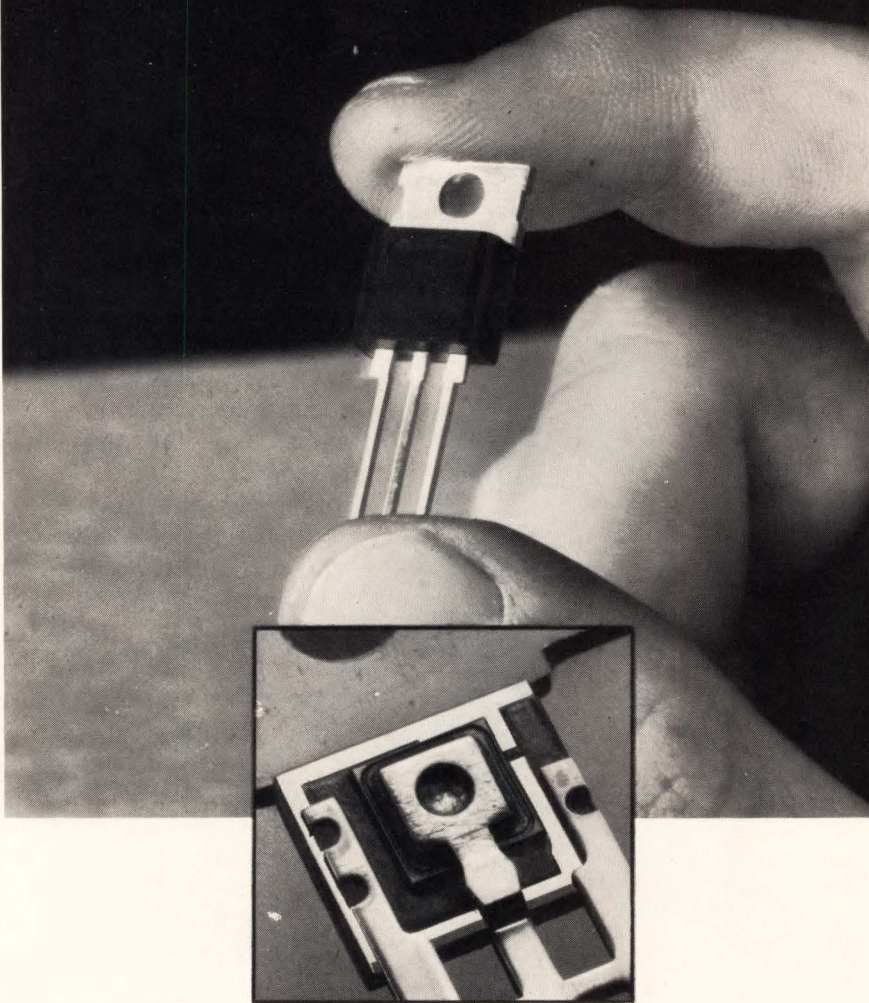

... the first with a face down chip
for high volume production!

Hutson is first with the TO-220 isolated device with face down chip that gives you improved thermal, electrical and mechanical performance. Hutson can produce more devices per day than ever before.

So call Hutson for your needs and remember . . . you got it first from Hutson . . . a leader in thyristor applications technology and one of the largest manufacturers of thyristors!



HUTSON INDUSTRIES
2019 W. VALLEY VIEW LANE
DALLAS, TEXAS 75234 (214) 241-3511
TWX 910-860-5537

EUROPEAN OFFICE: 30 RUE PIERRE SEMARD. YERRES, 91, FRANCE
TEL: Paris 948-8258 TELEX 21311

New products

quantities of 100 and up.

National Semiconductor Corp., 2900 Semiconductor Dr., Santa Clara, Calif. 95051. Phone Jerry Zis at (408) 737-5831 [413]

Bucket-brigade device offers 205-ms delay

A one-chip bucket-brigade device the model MN-3005 is a 4,096-stage unit that can provide delays of up to 205 milliseconds for audio-frequency signals. It has a near-zero insertion loss, making the use of an external amplifier unnecessary. In addition, it has a signal-to-noise ratio of 75 db.

Intended primarily to create echo and reverberation effects in electronic musical instruments, the bucket-brigade device can also be

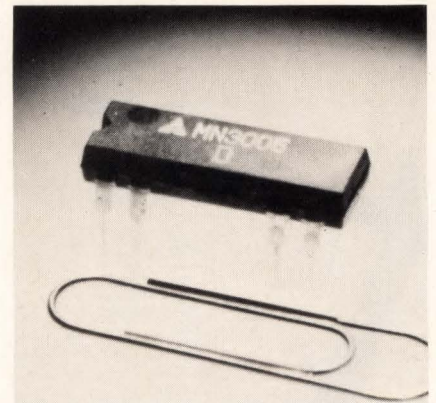

used for time compression or voice scrambling in communication systems and as a general-purpose fixed or variable analog delay line. The low-noise silicon-gate device is housed in a special 8-pin dual in-line package and sells for \$39 each in hundred-piece lots. Delivery is from stock to six weeks.

Panasonic, One Panasonic Way, Secaucus, N. J. 07094. Phone Bill Bottari at (201) 348-7276 [414]

Read-only memory stores 32,768 bits

Organized as 4,096 bytes, the SY2332 is a read-only memory with an access time of 450 nanoseconds.

BUSS ELECTRONIC FUSES.

Nearly every type of fuse and fuse holder you need to protect electronic circuits and devices you can get from us, easy. For example, Buss® Semiconductor Fuses; 700 volts, with extremely low I^2t and I_p let-thru values. TRON® Rectifier Fuses, ½ to 1,000 amps, up to 600 volts. Fusetron® dual-element time-delay fuses. Buss quick-acting glass tube fuses. Buss signal-indicating, alarm-activating fuses. TRON sub-miniature pigtail fuses. Buss sub-miniature GMW fuses. Buss telecommunications fuses. Buss military fuses. And Buss fuse holders and fuse blocks. Get your hands on exactly what you want. Write us now. Ask for Buss Bulletin SFB.

SUPPLIED THE ECONOMICAL WAY
THRU DISTRIBUTORS
BUSS FUSES
THE QUALITY LINE

BUSSMANN MANUFACTURING
a McGraw-Edison Company Division
Earth City, Missouri 63045



**WE MAKE IT EASY
TO GET YOUR HANDS
ON WHAT YOU WANT.**

Revolutionary cooling extrusion cuts size and cost in half.

Here is the first in a new series of unique cooling extrusions from Wakefield.

A totally different design concept called "High Fin Density" allows Extrusion 5113 to give the same cooling performance as devices needing nearly twice as much space.

And because of substantial material savings, the 5113 is half the price of the larger units—only \$1.10 per inch.

Until now, the space between fins of an extrusion could be no less than 1/4 the height of the fins. This limited the surface cooling area of the fins for any given size extrusion.

"High Fin Density" has changed all this by reducing the space between fins to as little as 1/10 their height. The result is a tremendous gain in cooling efficiency with 130 sq. in. of cooling surface per linear inch of extrusion.

Knowledgeable people say this is the most significant breakthrough in the history of cooling devices. But then, what would you expect from the leader? Write or call for full details.

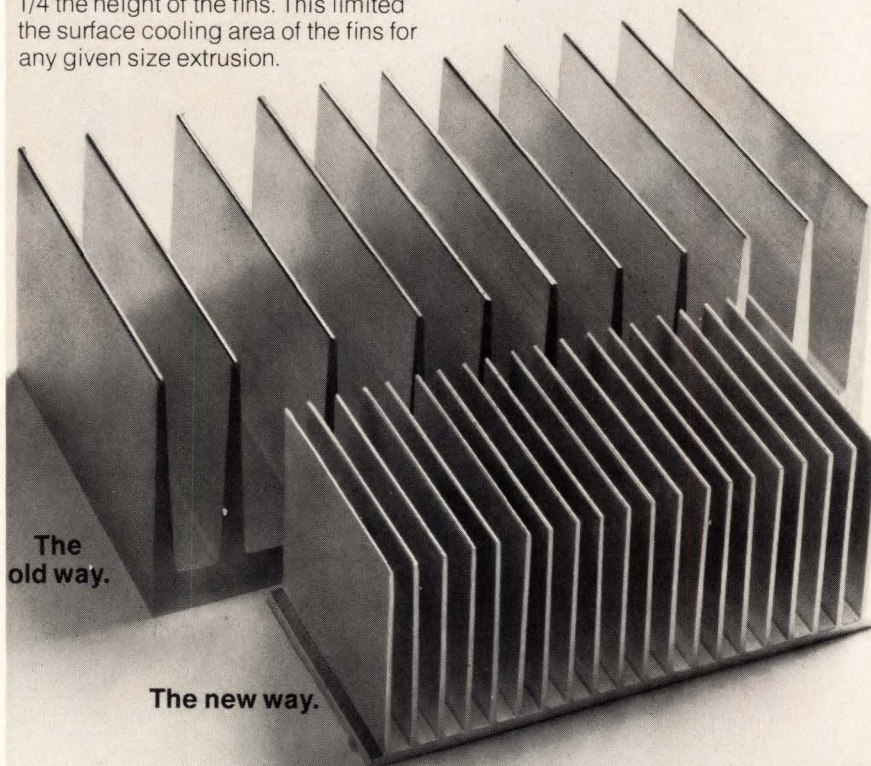

WAKEFIELD ENGINEERING INC.

77 AUDUBON ROAD, WAKEFIELD, MA 01880 (617) 245-5900
TWX 710-348-6713 AN EG&G COMPANY

Circle 154 on reader service card

1977 Answer Book. It makes your job easier. \$25.

Who makes what? Over 4000 products, more than 5000 manufacturers with their local contracts and distributors, directory of trade names and catalogs, post-paid inquiry cards for 5-second ordering of current catalogs.

Electronics Buyers' Guide
1221 Ave. of the Americas
New York, N.Y. 10020

Yes, send me a copy of The Answer Book. I've enclosed \$25 (USA and Canada only, elsewhere send \$35). Full money back guarantee if returned within 10 days.

Name

Company

Street

City

State

Zip

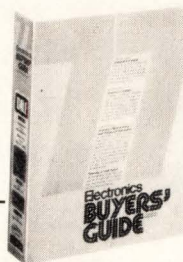

New products

The n-channel silicon-gate metal-oxide-semiconductor device will also be available soon in a 350-ns version for applications requiring more speed. Compatible with most popular microprocessors, the 32,768-bit ROM is offered in both ceramic and plastic 24-pin dual in-line packages. The memory, which operates off a single 5-v supply, sells for \$35 each in quantities of 100 to 999; there is also a one-time tooling fee of \$750 to \$1,000. Custom mask programming of wafers already in stock provides a turn-around time of three weeks for initial parts.

Synertek, P. O. Box 552, Santa Clara, Calif. 95052. Phone (408) 984-8900 [415]

Quad unit contains two op amps and two comparators

Unlike most quad-function analog integrated circuits, which contain four identical circuits, the MC3405/3505 combines two different functions: a pair of operational amplifiers similar to type MC3403/3503 and a pair of dc comparators similar to type LM339/139. The combination is useful in analog subsystems such as those found in automotive, consumer-product, and industrial circuits. The quad analog ICs can operate from a single supply of 3.0 to 36.0 v dc, or a dual supply from ± 1.5 to ± 18.0 v dc. The amplifiers and comparators are capable of common-mode inputs as low as the negative supply voltage.

Available from stock, the MC3405/3505 is available in two temperature ranges in plastic (P) and ceramic (L) dual in-line packages. The MC3405 operates in ambient temperatures from 0°C to 70°C, while the MC3505 is rated for operation in ambients over the range from -55°C to 125°C. Prices for lots of 100 and more pieces are as follows: MC3405P, \$1.15 each; MC3405L, \$1.50 each; and MC3505L, \$7.50 each.

Motorola Semiconductor Products Inc., P. O. Box 20912, Phoenix, Ariz. 85036. Phone Bob Benzer at (602) 962-3151 [417]

SORENSEN IS THE SOURCE.

FOR MODULAR SWITCHING POWER SUPPLIES.

Check our standard features:

- 10 models, 1.8V to 56V with power levels ranging up to 225 watts.
- 115/220 Vac input by external barrier strip change.
- 50/60-Hz operation with no derating.
- Logic shutdown for system applications.
- Extra long hold-up time.
- Low ripple & noise through use of double-stage filtering.
- Wide-range output voltage adjustment.
- Built-in adjustable overvoltage protection.
- Superior line and load regulation.
- Internal adjustable current limiting.
- UL component recognition.
- High power-to-weight ratio.
- 20-kHz switching.
- Size (in.): 3.313, 5.125, 9.500.
- Immediate delivery.
- Made in U.S.A. of quality components.
- Five-year warranty, backed by worldwide service organization.



\$312.
5V 30 Amps.

Check our specifications:

- AC Input Power:** 98 Vac-132 Vac, 187 Vac-250 Vac.
Frequency: 47-63 Hz single phase. 360-440 Hz (double rms Ripple spec.) *No derating.* Voltage selectable by a single link on the front panel.
- Voltage Regulation:** Line: 0.03% over full AC input range.
Load: 0.03% for zero to full load.
- Voltage Ripple:** Typical 2m V rms, 20mV pk-pk (20Hz to 20 MHz).
Max. 5mV rms, 50mV pk-pk (20Hz to 20MHz).
- Temperature Coefficient:** 0.01% max. per °C.
- Stability:** 0.05% max. for 24 hours after warm-up.
- Transient Response Time:** Output voltage returns to within 1% in less than 1.2 ms following a step-load change from either 50% to 100% or 100% to 50% of full load.
- Overshoot:** No overshoot at turn-on, turn-off or power failure.
- Hold-Up Time:** Full regulated voltage holds up for 40ms after removal of power at full load, and nominal input and output voltages (80ms for half load).
- Overvoltage Protection:** Built-in adjustable overvoltage protection standard on all models.
- Efficiency:** Up to 78%.
- Remote Sensing:** Voltage drops can be compensated for up to the max. specified terminal voltage.
- Paralleling:** May be directly paralleled without derating.
- Soft-Start:** In-rush current is limited by soft start circuit.

Model No.	Nominal Voltage	Output Voltage Range (Vdc)		Output Current				Price
		min.	max.	@40°C	@50°C	@60°C	@71°C	
SSD2-30	2	1.8	3.0	30.0	27.0	22.5	15.0	\$312
SSD5-30	5	4.7	6.5	30.0	27.0	22.5	15.0	312
SSD9-20	9	6.5	9.5	20.0	18.0	15.0	10.0	312
SSD12-15	12	9.5	13.0	15.0	13.5	11.2	7.5	312
SSD15-12	15	13.0	17.0	12.0	10.8	9.0	6.0	312
SSD18-10.5	18	16.0	21.0	10.5	9.4	7.8	5.2	312
SSD24-8.5	24	20.0	26.0	8.5	7.6	6.3	4.2	312
SSD28-7	28	25.0	33.0	7.0	6.3	5.2	3.5	312
SSD36-5	36	32.0	43.0	5.0	4.5	3.7	2.5	312
SSD48-4	48	42.0	56.0	4.0	3.6	3.0	2.0	312

**For OEM discounts call:
Sorensen, (603) 668-4500.
676 Island Pond Road,
Manchester, NH 03103.**

SORENSEN
POWER SUPPLIES

A Raytheon Company

Circle 155 on reader service card

THE STANDARD FOR INERTIAL NAVIGATION SYSTEMS

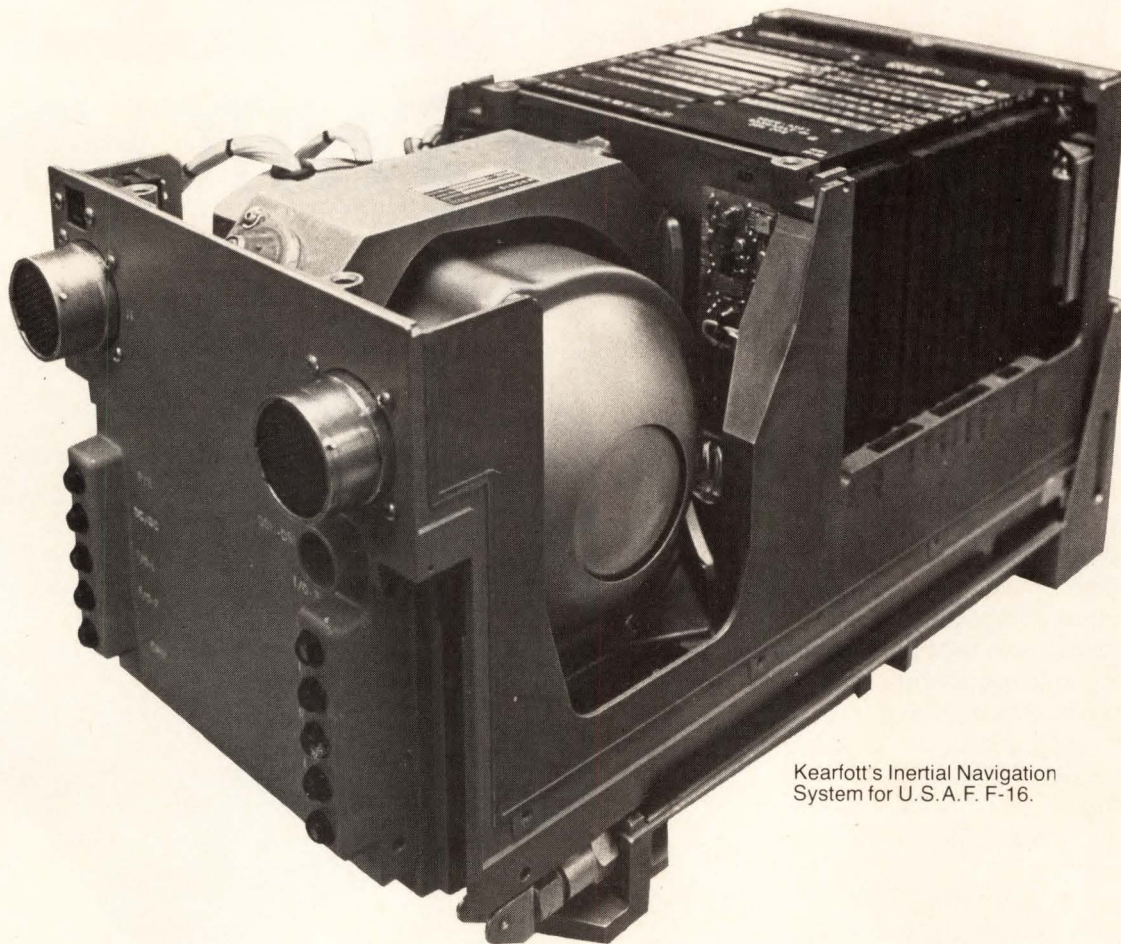

Kearfott's Inertial Navigation System for U. S. A. F. F-16.

Kearfott's Inertial Navigation System (INS) for the F-16 consists of two major line replaceable units—Inertial Navigation Unit (INU), and a Fire Control Navigation Panel (FCNP). It is a prime sensor for aircraft velocity, attitude, and heading, and a prime source of navigation information.

Navigational data are developed from self-contained inertial sensors consisting of a vertical accelerometer, two horizontal accelerometers, and two-axis displacement GYROFLEX® gyroscopes. The sensing elements are mounted in a four gimbal, gyro-stabilized inertial platform with the accelerometers, which are maintained in a known reference frame by the gyroscopes, as the primary source of information. Attitude and heading information is obtained from synchro devices mounted between the platform gimbals.

The system provides pitch, roll, and heading in both analog (synchro) and digital form. In addition, the following outputs are provided on a serial MUX channel (MIL-STD-1553):

- Present Position—Latitude, Longitude, Altitude
- Aircraft Attitude—Pitch, roll, Heading (True and Magnetic)
- Aircraft Velocity—Horizontal and Vertical
- Steering Information—Track Angle Error

In order to permit operation in aided-inertial configurations, the INS accepts the following digital

inputs in MUX serial format (MIL-STD-1553):

- Position Update—Latitude and Longitude
- Velocity Update—Velocities in INS coordinates
- Angular Update—Angles about INS axes
- Gyro Torquing Update—Torquing rate to INS gyro axes

Significant features:

- MUX interface (MIL-STD-1553)
- Lightweight—33 pounds
- Small Size—7.5" h x 15.2" d x 7.5" w
- High Precision—better than 1 nm/h
- Rapid Align—9 minutes at 0° F
- Fast Installation/Removal—rack and panel-type mechanical interface
- Provides Back-up MUX Control in Event of Fire Control Computer Failure

For additional information write to: The Singer Company, Kearfott Division, 1150 McBride Ave., Little Falls, N. J. 07424.

Kearfott

a division of The SINGER Company

Electronics / December 8, 1977

VACTEC Photodetectors

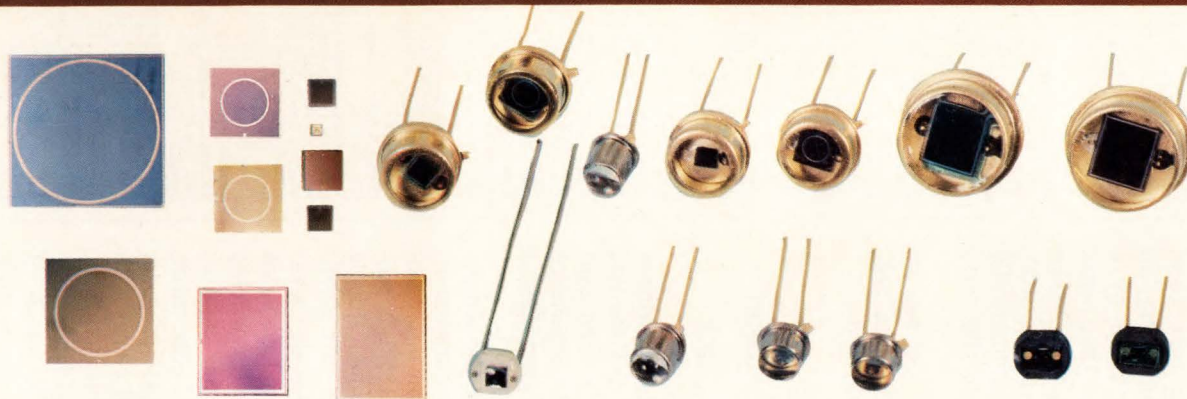

Dumb looking little chips for silicon are tough to advertise. They don't look like much, but they do remarkable things, if you can use microamperes of light current (at 100 f.c.) vs. picoamperes of dark current for a million-to-one signal-to-noise ratio. Linearity and stability are super with a surprising response to visible and blue light (400 nm). These BES (blue enhanced silicon) photodiodes are available in a variety of ceramic or metal hermetic packages so that you needn't be expert at handling these insignificant looking chips.

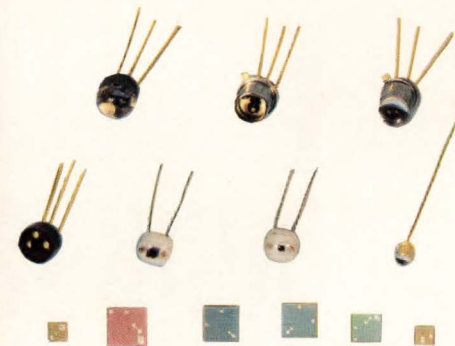

Almost equally as dull looking are the phototransistor and photodarlington transistors. Since they don't look much different than the others, why buy ours? One reason is that we test what we specify. Not only are the wafers one hundred per cent probe tested, but once the devices are packaged (in equally insignificant looking packages), we one hundred per cent sort for light-current characteristics, dark current (leakage), and breakdown.

Even though our devices are as good as we say and reasonably priced, so what is different? Our dedication to this industry is remarkable for a small company. We have technology normally found at only the giants of the semi-conductor industry. At this one facility in Maryland Heights, Missouri, we not only make photodiodes and phototransistors but custom LSI light actuated CMOS IC's for the new Kodak cameras. Even more remarkably, we not only process these chips in entirety, we design the circuits. When you can do such processes as silicon gate CMOS, and epitaxy for bipolar, you learn a lot about silicon chemistry that necessarily spills over to the production of photodiodes and phototransistors. Coupling this with our photometric expertise gained through seventeen years of experience makes an unbeatable combination. We even assemble our own special purpose computers for testing both IC's, transistors, and diodes as well as making many of our own parts handlers to feed the parts into position for automatic testing with a calibrated light source. We don't just brag about "planar" processing, we do all types of silicon processing. This high level of silicon technology plus our exclusive dedication to photodetection must inevitably make our phototransistors and photodiodes a little better than the rest.

So that our CDS, selenium, silicon solar cell, and coupler departments won't feel left out, we make the best of those devices also. It's just that they have had their share of our advertising dollars in the past.

Talk to us but better yet, visit us and we think you'll not only be impressed but amazed. We'd like to work closely with your applications people, and making custom photodevices of any kind is no big deal for us at Vactec.

Write today for catalogs and more information: 2423 Northline Industrial Blvd., Maryland Heights, Mo. 63043 • (314) 872-8300

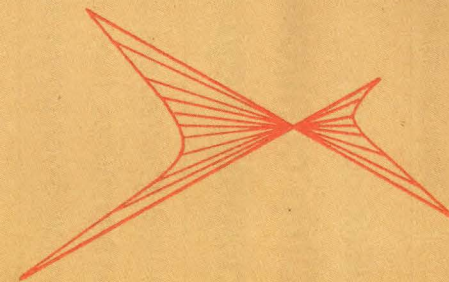

VACTEC, INC.

Circle 157 on reader service card

New products

Microprocessors

Chip controls display, keyboard

40-pin IC interfaces with all 8-bit buses, runs on simple 5-volt power supply

While the microcomputer is reducing the costs and increasing the capability of system designs across the applications spectrum, nowhere is its impact felt more than in peripheral-equipment designs. And although microcomputer suppliers themselves are offering large-scale-integrated peripheral controllers for their respective families, other manufacturers are designing chips that operate with any family. Such a company is Matrox Electronic Systems, a small Montreal-based peripheral manufacturer. Its alphanumeric-display/keyboard controller is the first of a line of intelligent single-chip peripheral interface devices for controlling displays, keyboards, printers, and other peripherals. Capable of interfacing directly with all 8-bit microcomputer buses, including the 8080 and 6800, it is one of the most powerful controllers of its kind to enter the market.

The display portion of the MTX-AI provides all the timing and refresh signals for driving up to 32 widely used 5-by-7-dot-matrix light-emitting-diode displays. The keyboard portion provides all the scanning signals, debounce and decoding for any keyboard with up to 64 keys. It operates on a single 5-volt power supply and requires no external refresh, as is the case with some other display/keyboard controllers.

The 40-pin part packs on one chip all microprocessor interface logic, character-generating read-only memory, display-refresh random-access memory, and timing and input/output interface functions. The 64-by-5-by-7-bit ROM generates the characters for the standard 64-character ASCII set, while the on-

chip 32-byte RAM provides the refresh data directly under control of the central processing unit. A three-state bidirectional data bus transfers data and commands between the CPU and the MTX-AI. Here, simple write strobes enable the CPU to write the data and commands into the MTX-AI, while read strobes read data and determine the status of the chip.

As well as executing all the instructions for display and keyboard manipulation, the chip can be programmed to handle such special-purpose parameters as display length, intensity, and keyboard scan. In these instructions, each command has a unique 8-bit code that starts the operation. When under way, an interrupt prevent is initiated by a command from the CPU that resets the MTX-AI busy flag to 0. When the MTX-AI finishes the instruction, the flag will be automatically set to 1, in readiness for the CPU's next command.

Matrox Electronic Systems, P. O. Box 56, Ahuntsic Stn., Montreal, Que. H3L 3N5, Canada. Phone (514)481-6838 [361]

Minicomputer is a 228-on-expandable teaching tool

RCA's second microcomputer, Microtutor II, will serve as a teaching aide for engineers, hobbyists, and students who want hands-on experience with operating and programming a computer system.

The system is based on the company's earlier complementary-metal-oxide-semiconductor 8-bit microprocessor. The new CDP18S012 provides input via eight binary toggle switches and output on two seven-segment light-emitting-diode hexadecimal digit displays and a Q LED output. Additional toggle switches are provided for all the controls required to examine and alter memory locations and to initiate program execution. Microtutor II comes with a 64-page instruction manual written especially for the beginner.

The system has 256 bytes of C-MOS random-access memory on a

TI Distributors

ALABAMA: Huntsville, Hall-Mark/Huntsville (205) 837-8700.
ARIZONA: Phoenix, Kierulff Electronics (602) 243-4101; R. V. Weatherford (602) 272-7144; Tempe, G. S. Marshall (602) 968-6181.
CALIFORNIA: Anaheim, R. V. Weatherford (714) 634-9600; Canoga Park, G. S. Marshall (213) 999-5001; El Monte, G. S. Marshall (213) 686-0141; El Segundo, TI Supply (213) 973-2571; Glendale, R. V. Weatherford (213) 849-3451; Goleta, RPS, Inc. (805) 964-6823; Irvine, Cramer/Los Angeles (714) 979-3000; (213) 771-8300; G. S. Marshall (714) 556-6400; Los Angeles, Kierulff Electronics (213) 685-5511; RPS, Inc. (213) 748-1271; Mountain View, Time Electronics (408) 965-8000; Palo Alto, Kierulff Electronics (415) 968-6292; Pomona, R. V. Weatherford (714) 623-1261; San Diego, Cramer/San Diego (714) 565-1881; Kierulff Electronics (714) 278-2112; G. S. Marshall (714) 278-6350; RPS Inc. (714) 292-5611; R. V. Weatherford (714) 278-7400; Sunnyvale, Cramer/San Francisco (408) 739-3011; G. S. Marshall (408) 732-1100; TI Supply (408) 732-5555; Torrance, Time Electronics (213) 320-0880; Tustin, Kierulff Electronics (714) 731-5711; Woodland Hills, JACO (213) 884-4560.
COLORADO: Denver, Cramer/Denver (303) 758-2100; Kierulff Electronics (303) 371-6500; Englewood, R. V. Weatherford (303) 761-5432.
CONNECTICUT: Hamden, Arrow Electronics (203) 248-3801; TI Supply (203) 281-4669; North Haven, Cramer/Connecticut (203) 239-5641; Orange, Milgray/Connecticut (203) 795-0714.
FLORIDA: Clearwater, Diplomat/Southland (813) 443-4514; Ft. Lauderdale, Arrow Electronics (305) 776-7790; Hall-Mark/Miami (305) 971-9280; Hollywood, Cramer/Hollywood (305) 921-7878; Orlando, Cramer/Orlando (305) 894-1511; Hall-Mark/Orlando (305) 855-4020; Winter Park, Milgray Electronics (305) 647-5747.
GEORGIA: Doraville, Arrow Electronics (404) 455-4054; Norcross, Cramer/Atlanta (404) 448-9050.
ILLINOIS: Arlington Heights, TI Supply (312) 640-2964; Elk Grove, Hall-Mark/Chicago (312) 437-8800; Kierulff Electronics (312) 640-0200; Chicago, Newark Electronics (312) 638-4411; Mt. Prospect, Cramer/Chicago (312) 593-8230.
INDIANA: Ft. Wayne, Ft. Wayne Electronics (219) 423-3422; Indianapolis, Graham Electronics (317) 634-8202.
IOWA: Cedar Rapids, Deeco (319) 365-7551.
KANSAS: Shawnee Mission, Hall-Mark/Kansas City (913) 888-4747.
MASSACHUSETTS: Billerica, Kierulff Electronics (617) 667-8331; Newton, Cramer/Newton (617) 969-7700; Waltham, TI Supply (617) 890-0510; Woburn, Arrow Electronics (617) 933-8130.
MARYLAND: Baltimore, Arrow Electronics (202) 737-1700; (301) 247-5200; Hall-Mark/Baltimore (301) 796-9300; Columbia, Technico (301) 461-2200; Gaithersburg, Cramer/Washington (301) 948-0110; Kierulff Electronics (301) 948-0250; Hyattsville, Milgray/Washington (301) 459-2222.
MICHIGAN: Ann Arbor, Arrow Electronics (313) 971-8220; Detroit, Newark Electronics (313) 967-0600; Grand Rapids, Newark Electronics (616) 241-6681.
MINNESOTA: Bloomington, Arrow Electronics (612) 887-6400; Edina, Cramer/Minnesota (612) 835-7811.
MISSOURI: Earth City, Hall-Mark/St. Louis (314) 291-5350; Kansas City, LCOMP-Kansas City (816) 221-2400; St. Louis, LCOMP-St. Louis (314) 291-6200.
NEW HAMPSHIRE: Manchester, Arrow Electronics (603) 668-6968.
NEW JERSEY: Camden, General Radio Supply (609) 964-8560; Cherry Hill, Cramer/Pennsylvania (215) 923-5950; (609) 424-5993; Milgray/Delaware Valley (609) 424-1300; (215) 228-2000; Clark, TI Supply (201) 382-6400; Clifton, Wilshire Electronics (201) 340-1900; Little Falls, Cramer/New Jersey (201) 785-4300; Moorestown, Arrow Electronics (609) 235-1900; Rutherford, Kierulff Electronics (201) 935-2120; Saddlebrook, Arrow Electronics (201) 797-5800.
NEW MEXICO: Albuquerque, Cramer/New Mexico (505) 243-4566; International Electronics (505) 265-6453.
NEW YORK: East Syracuse, Cramer/Syracuse (315) 437-6671; Endwell, Wilshire Electronics (607) 754-1570; Farmingdale, Arrow Electronics (516) 694-6800; Hicksville, Kierulff Electronics (516) 433-5530; Fishkill, Arrow Electronics (914) 896-7530; Freeport, Milgray Electronics (516) 546-6000; N.J. (800) 645-3966; Hauppauge, Cramer/Long Island (516) 271-5600; JACO (516) 273-1234; Rochester, Cramer/Rochester (716) 275-0300; Rochester Radio Supply (716) 454-7800; Wilshire Electronics (716) 442-9560.
NORTH CAROLINA: Raleigh, Hall-Mark/Raleigh (919) 832-4465; Winston-Salem, Cramer/Winston-Salem (919) 725-8711.
OHIO: Cleveland, Arrow Electronics (216) 464-2000; Cramer/Cleveland (216) 248-8400; Columbus, Hall-Mark/Ohio (614) 846-1882; Dayton, ESCO Electronics (513) 226-1133; Kettering, Arrow Electronics (513) 253-9176.
OKLAHOMA: Tulsa, Hall-Mark/Tulsa (918) 835-8458; TI Supply (918) 582-8272.
PENNSYLVANIA: Huntingdon Valley, Hall-Mark/Philadelphia (215) 355-7300.
TEXAS: Austin, Hall-Mark/Austin (512) 837-2814; Dallas, Hall-Mark/Dallas (214) 234-7400; TI Supply (214) 238-6821; El Paso, International Electronics, (915) 778-9761; Houston, Hall-Mark/Houston (713) 781-6100; Harrison Equipment (713) 652-4700; TI Supply (713) 776-6511; R. V. Weatherford (713) 688-7406.
UTAH: Salt Lake City, Diplomat/Altalund (801) 486-4134; Standard Supply (801) 486-3371.
VIRGINIA: Roanoke, Technico (703) 563-4975.
WASHINGTON: Seattle, Almac/Stroum Electronics (206) 763-2300; Cramer/Seattle (206) 575-0907; Kierulff Electronics (206) 575-4420.
WISCONSIN: Brookfield, Newark Electronics (414) 781-2450; Oak Creek, Arrow Electronics (414) 764-6600; West Allis, Hall-Mark/Milwaukee (414) 476-1270.
CANADA: Calgary, Cam Gard Supply (403) 287-0520; Downsview, CESCO Electronics (416) 661-0220; Zentrionics (416) 635-2822; Edmonton, Cam Gard Supply (403) 426-1805; Halifax, Cam Gard Supply (902) 454-8561; Kamloops, Cam Gard Supply (604) 372-3338; Moncton, Cam Gard Supply (506) 855-2200; Montreal, CESCO Electronics (514) 735-5511; Future Electronics (514) 735-5775; Zentrionics (514) 735-5361; Ottawa, CESCO Electronics (613) 729-6411; Quebec City, CESCO Electronics (418) 524-4641; Regina, Cam Gard Supply (306) 525-1317; Rexdale, Future Electronics (416) 677-7820; Saskatoon, Cam Gard Supply (306) 652-6424; Vancouver, Cam Gard Supply (604) 291-1441; Winnipeg, Cam Gard Supply (204) 786-8481.

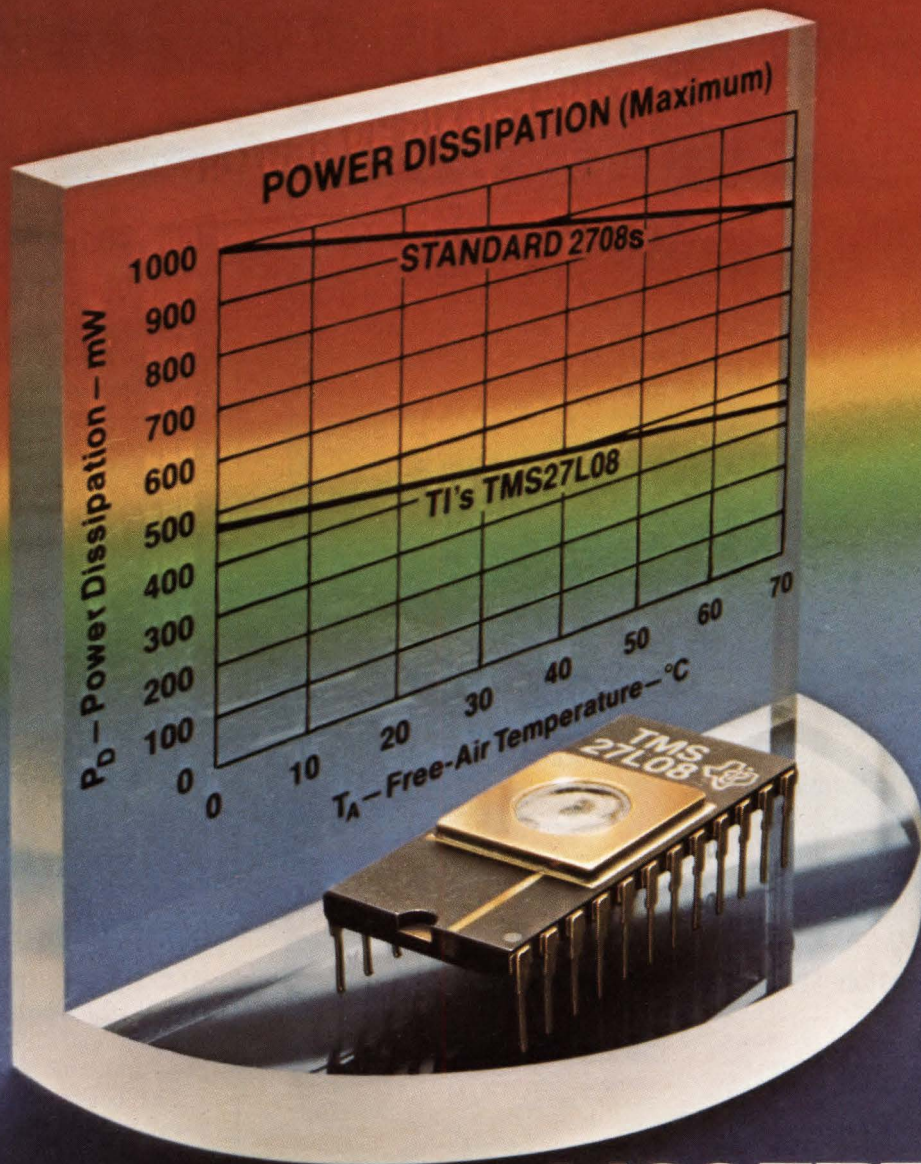

MOS EPROMs

The available low-power EPROM. TMS27L08...from Texas Instruments.

If power is a problem in your high-density, fixed memory applications, use TI's new 8K EPROM. The low-power TMS 27L08.

Pin-for-pin compatible with the standard 2708, it requires less than half the power. Typically 245 mW.

The TMS 27L08 also features $\pm 10\%$ power supply voltage tolerances, and increased output drive capability. When interfaced with standard TTL, the TMS 27L08 has

guaranteed dc noise immunity in both high and low states.

Easily erased and reprogrammed, the new TMS 27L08 is ideal where programs must be debugged quickly. It's available now in a 24-pin ceramic DIP at \$21.50 each (100 pieces).

For existing designs, plug in TI's TMS 2708. It's identical to the standard version; \$15.40 each in 100 pieces.

Once your program is defined, you can use the economical, pin-compatible, mask programmed TMS 4700 ROM for large production runs.

To get your 27L08s fast, or for more data on the 27L08, 2708, and 4700, call your TI distributor. Or write Texas Instruments, P. O. Box 1443, M/S 669-27L08, Houston, Texas 77001.



TEXAS INSTRUMENTS
INCORPORATED

PEEK-A-BUG.



Free Catalog on
Breadboarding Aids & More!

From the great socket-makers comes a world of universal designers, bread-boxes, and every other microelectronic training aid you could ever use.

Inside these pages lies the simple road to circuit design, from solderless breadboarding to complete

design systems. And it's all for the asking. Send for our free 24 page "Bugworks"® catalog today!



E&I INSTRUMENTS, INC.
61 First Street, Derby, Conn. 06418
(203) 735-8774 Telex No. 96 3536

Authorized Stocking Representatives

Los Angeles, Calif. (213) 328-9770	New York, N.Y. (201) 467-8585
San Francisco, Calif. (415) 961-2828	Syracuse, N.Y. (315) 699-2651
Woodbridge, Conn. (203) 397-1461	Dayton, Ohio (513) 222-0011
Denver, Colorado (303) 534-1356	Philadelphia, Pa. (215) 723-8733
Orlando, Florida (305) 351-1841	Dallas, Texas (214) 328-5484
Chicago, Illinois (312) 956-8090	Fairfax, Virginia (703) 273-1803
Kansas City, Kansas (913) 649-8952	Seattle, Washington (206) 938-4166

Canada
Edmonton, Alberta
(403) 455-4122
Winnipeg, Manitoba
(204) 774-6286
or 772-9295
Vancouver,
British Columbia
(604) 687-2621



TM

Circle 160 on reader service card

If this magazine is worth your time, it's worth 54¢.

Drop off the routing list. Avoid the Perils of Passalong. Get your own fresh, unclipped copy mailed to your home or office. \$14 (54¢ per issue) for a one-year U.S. subscription. (\$16 in Canada.) Turn to the subscription card in the back of the magazine. If somebody beat you to it, write: Electronics, P.O. Box 430, Hightstown, N.J. 08520.

New products

card that attaches to the base through a standard 44-pin connector. An additional prewired socket and a set of connector holes are available for extra RAM and input/output interfaces. A crystal clock stabilizes the timing applications. Programs are loaded by the on-chip direct-memory-access facility, which eliminates the need for a bootstrap loading routine.

Microtutor II is run by a 115-v, 50-/60-HZ power line and is only 7 inches long, 5½ in. wide, and 3½ in. high. Single quantities are priced at \$195.

RCA Solid State Division, Box 3200, Somerville, N. J. 08876 [363]

Prototyping package speeds microcomputer design

Designers can quickly construct and debug custom interface systems using a new prototyping package based on National Semiconductor's BLC 80/10 board level computers. The BLC 80P consists of an 80/10 board with 1,024 words of random access memory and 2,048 words of blank programmable read-only memory.

The board has 48 programmable parallel input/output lines that are socketed to accommodate interchangeable line drivers and terminators. The package includes 10 DM 7437 open-collector line drivers, 10 BLC 902 1-kΩ terminating resistor networks, and 10 BLC 220/330-Ω terminating register networks.

The system is housed in a BLC 604 cage that serves as a backplane, providing power bussing and access to system bus signals. The board has jumper-selected options for operation in the current-loop mode, and

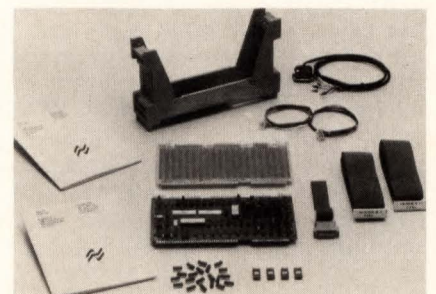

State of the art leadership in mass terminations ...that's what the BLUE MACS™ System is all about!

LEADERSHIP IN MASS TERMINATION DESIGN FLEXIBILITY begins with a complete package of BLUE MACS connector styles and sizes to meet your varied interconnect requirements. An expanded standard cable package that includes round conductor cable for intra-cabinet wiring, flat conductor cable for high flex life applications, and U.L. listed jacketed cable for external interconnect requirements. A tool package that includes hand and bench versions, cable cutters and separators, discrete wire fixtures and accessories.

LEADERSHIP IN MASS TERMINATION CONTACT RELIABILITY starts with our exclusive patented TULIP™ contact that provides 4 points of electrical contact per conductor for gas-tight, corrosion-free ter-

minations. Comprehensive test information is available upon request.

LEADERSHIP IN LOWER INSTALLED COSTS begins with a one piece connector design that eliminates unnecessary handling to reduce installation time by as much as 65%. This one piece design incorporates mating grooves which assures positive cable to connector alignment, and it eliminates the operator variable when assembling the cable to the connector. Insulation displacing TULIP contacts let you simultaneously mass terminate up to 60 conductors in seconds —without wire stripping or soldering.

A colorful reference guide tells the full reliability story about our complete systems package. Ask your local Ansley distributor for a free copy of the BLUE MACS Wall Chart. Or write us, direct.

T&B / Ansley

The mass termination company.

T&B/Ansley Corporation
Subsidiary of Thomas & Betts Corporation
3208 Humboldt St., Los Angeles, CA 90031
Tel. (213) 223-2331 • TWX 910-321-3938



Stocked and sold through authorized Ansley distributors.

International Offices: AUSTRALIA, Brookvale, (02) 938-1713 • CANADA, Iberville, Quebec, (514) 658-6611 • SOUTH AFRICA, Benrose, 24-8134 • ENGLAND, Luton, (0582) 597-271 • WEST GERMANY, Dreieichenhain bei Frankfurt, 06103-8 20 21 • FRANCE, Rungis, 687-23-85 • JAPAN, Tokyo, 03-354-9661 • SWEDEN, Upplands Vasby, 0760-86140 ITALY, Milano, 02-431216.

Circle 161 on reader service card

MAGNETIC SHIELDING

MATERIAL

- CO-NETIC AA Alloy
High Permeability
.002" to .100" thick

EXCLUSIVE

Perfection Annealed — No further anneal required if severe forming is avoided.

- NETIC S3-6 Alloy — High Saturation Induction.
.004" to .095" thick
- Immediate Shipment from Stock

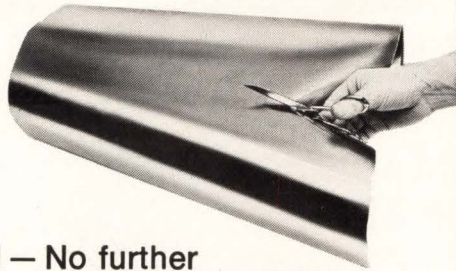

MAGNETIC SHIELD DIV.



PERFECTION MICA CO.
740 North Thomas Drive
Bensenville, Ill. 60106, USA
Phone 312 / 766-7800
TWX 910-256-4815

SEND FOR NEW MG-4
Material, Application
and Fabrication Guide.

*Complimentary Foil
Samples Included.*

Circle 162 on reader service card

CUSTOM CRYSTAL FILTERS

Call Vic Gill (714) 759-2411

Or send for new brochure:
500 Superior Ave., Newport Beach, CA 92663

HUGHES

HUGHES AIRCRAFT COMPANY

MICROELECTRONIC PRODUCTS DIVISION

Circle 238 on reader service card

STANDARD ELECTRONIC MODULES

Call Ed Gray (714) 759-2411

Or send for new brochure:
500 Superior Ave., Newport Beach, CA 92663

HUGHES

HUGHES AIRCRAFT COMPANY

MICROELECTRONIC PRODUCTS DIVISION

162 Circle 239 on reader service card

New products

cables are supplied for a cathode-ray-tube terminal and for a teletypewriter.

The package is priced at \$878. National Semiconductor Corp., 2900 Semiconductor Drive, Santa Clara, Calif. 95051. Call Don Share at (408) 737-5166 [365]

AMD offers support circuits for fast microprocessors

Two support circuits for use with the high-speed (250-nanosecond clock period) Am9080A-4, metal-oxide-semiconductor microprocessor are now available.

The Am8224-4 is a high-speed clock generator containing a crystal-controlled oscillator, a divide-by-nine counter, high-level drivers, and auxiliary logic functions.

The 8238-4 is an 8-bit driver for bidirectional busses that buffer the Am9080A/8080A data bus memory and input/output devices. The bus driver offers an extended memory write pulse width, making it ideal for use in large-system timing controls. These circuits are available in hermetically sealed ceramic dual in-line packages for use over the commercial temperature range.

Prices start at \$8.10 for the Am8224-4 and \$8.15 for the Am8238-4 in lots of 100 units or more.

Advanced Micro Devices Inc., 901 Thompson Pl., Sunnyvale, Calif. 94086. Phone (408) 732-2400 [366]

Machine-code relocater works with 6800 processor

A machine-code relocater for use with microcomputers built around the 6800 microprocessor permits the user to move assembly-language programs from one area in memory to another. A special feature of the relocater facilitates loading a Motorola Mikbug format tape directly into any part of the system memory. The relocater sells for \$8.

Technical Systems Consultants Inc., P. O. Box 2574, West Lafayette, Ind. 47906 [367]

From Electronics Magazine Book Series. Zero-risk trial offer.



Circuits for Electronics Engineers

Contains 306 circuits arranged by 51 functions from Amplifiers to Voltage Regulating Circuits. Saves design drudgery. \$15.95

Electronics Book Series

P.O. Box 669, Hightstown, N.J. 08520

Send me _____ copies of "Circuits for Electronics Engineers" at \$15.95 per copy.

Discounts of 40% on orders of 10 or more copies.

I must be fully satisfied or you will refund full payment if the book is returned after ten-day trial examination.

Payment enclosed Bill firm Bill me

Charge to my credit card:

American Express Diners Club

BankAmericard Master Charge

Acc't No. _____

Date exp. _____

On Master Charge only, first numbers above name _____

Name _____ Title _____

Company _____

Street _____

City _____ State _____ Zip _____

Signature _____

GRINNELL DISPLAYS:

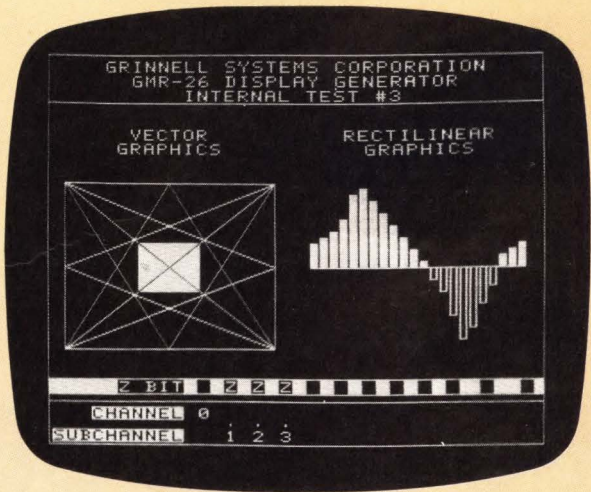
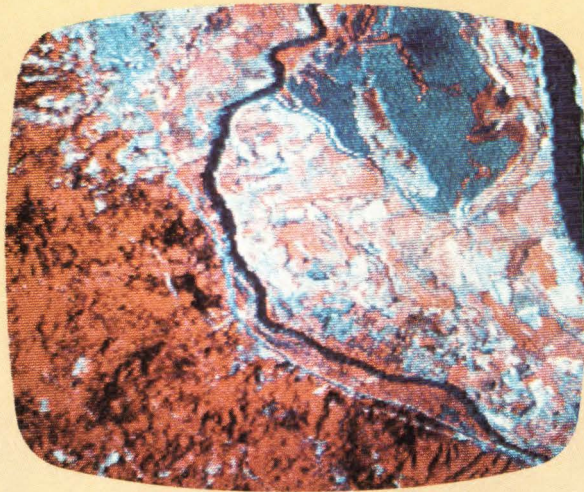
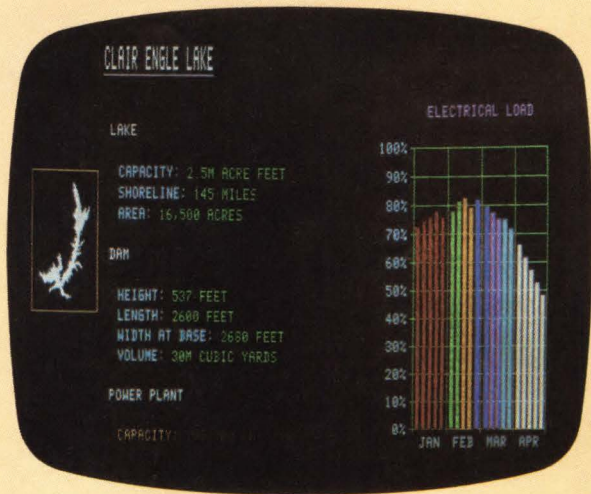
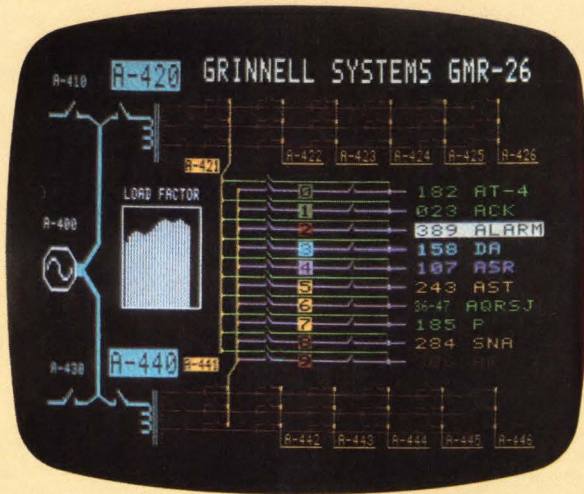

Complex color imaging . . . graphics . . . grey scale . . . basic black and white: our 100% solid state graphic television display systems can be matched to your computer display requirement, easily and economically.

And, they're intelligent. Powerful instruction sets minimize software overhead, simplify programming and eliminate the need for complex macro-instructions and

high order programming languages.

Further, every Grinnell system includes a standard computer interface, full alphanumeric and graphics, 4K MOS random access refresh memories and your choice of standard resolutions: 256 x 256, 256 x 512 or 512 x 512. Plug-compatible interfaces for most minicomputers are available, along with a large number of

operating options. All systems drive standard TV monitors.

So, before you make any decision about computer display systems, talk to the Grinnell experts. Our engineers have been in the display picture longer than most, and their experience shows. Complete operating systems start at \$5,700, and quantity discounts are available. For detailed specs and/or a quotation, call or write.

GRINNELL SYSTEMS

2986 Scott Boulevard, Santa Clara, California 95050 (408) 988-2100

Circle 163 on reader service card

“IF YOU ARE CONSIDERING AN ALPHA NUMERIC DISPLAY

for your product, don't place an order until you've seen our **SUPER SMART** single liners.*”



- 10, 20, 32 and 40 character/column models.
- All drive, interface and refresh circuitry included at no extra charge.
- Mounting kits, bezels, and a full array of filter types and colors available.
- Bright, sharp, highly readable characters, even in sunlight, with proper filtering.
- Complete software manual, mounting diagrams and interface schematics. Technical advice from our systems engineers — who have already solved many of the problems you are facing.
- Vacuum fluorescent technology for low power consumption.

* Let one of our field representatives show you why. Just give us a call.

Northeast

Herb Degan, (201) 746-8900

Central Atlantic

Tom Cruse, (703) 569-2700

Southeast

Frank Magaro, (404) 252-6609

Florida

Paul Whisenant, (813) 596-5331

Rocky Mountains

Tom Buirley, (303) 841-2788

Ohio Valley

Griffin Ashby, (513) 252-5627

California

Gene McClenning, (415) 941-2113

Northwest

Bob Smith, (206) 453-8200

Gulf States

Dick Larson, (214) 361-8584

Roger Martin, (713) 440-8066

Southwest

Burt Dieruf, (505) 299-0989

Central States

Gordon Fixman, (314) 725-5219

Eugene Shapiro, (913) 648-0124

Ben Penn, (316) 682-9433

FOR READABILITY, STRIKING APPEARANCE, AND COST EFFECTIVE DESIGN



DIGITAL ELECTRONICS CORPORATION 415 PETERSON STREET • OAKLAND, CALIFORNIA 94601 • (415) 532-2920

Circle 268 on reader service card

The magazine you're reading now, could be your own.

Drop off the routing list. Get your own fresh, unclipped copy mailed to your home or office. Turn to the subscription card in the back of

the magazine. If somebody has beat you to it, write: Electronics, P.O. Box 430, Hightstown, N.J. 08520.



"A few words about imitation and flattery."

"The early days of in-circuit testing development were lonely. Those of us who believed in this new inspection testing technique for printed circuit board production found few converts. But we persevered. We built the hardware and the fixtures to interface with the PCBs to be tested. We developed control systems and software to make testing faster, more reliable and more versatile. Most important of all, we demonstrated unheard of improvement in yield of good boards and substantial reduction in costs for our customers.

We're not lonely anymore. We've made believers and customers of many of the major electronics manufacturers in the U. S. and abroad. And we've made believers and competitors of several test equipment manufacturers with convincing evidence that positive electrical access to the PCB solder nodes is the method of choice for verifying circuit integrity and performing non-destructive component tests on analog, digital and hybrid boards.

We're flattered by our imitators. And we welcome the competition. It's certain to benefit the industry as a whole and it will keep us on our toes in the effort to maintain our position of leadership.

When you want reliable, cost-effective production line test systems to increase your printed-circuit board yields, you have to consider in-circuit testing. And when you consider in-circuit testing, it makes sense to check with the people who led the way and lead today in technology, sales and service.

Let us show you how you can save money testing analog, digital and hybrid boards. Call or write to arrange a demonstration and we'll make you a believer."

M. E. Stanford, President

FF FAULTFINDERS
15 AVIS DRIVE, LATHAM, NY 12110
(518) 783-7786

Faultfinders systems can help you to better testing at lower cost. Believe it.

Circle 165 on reader service card

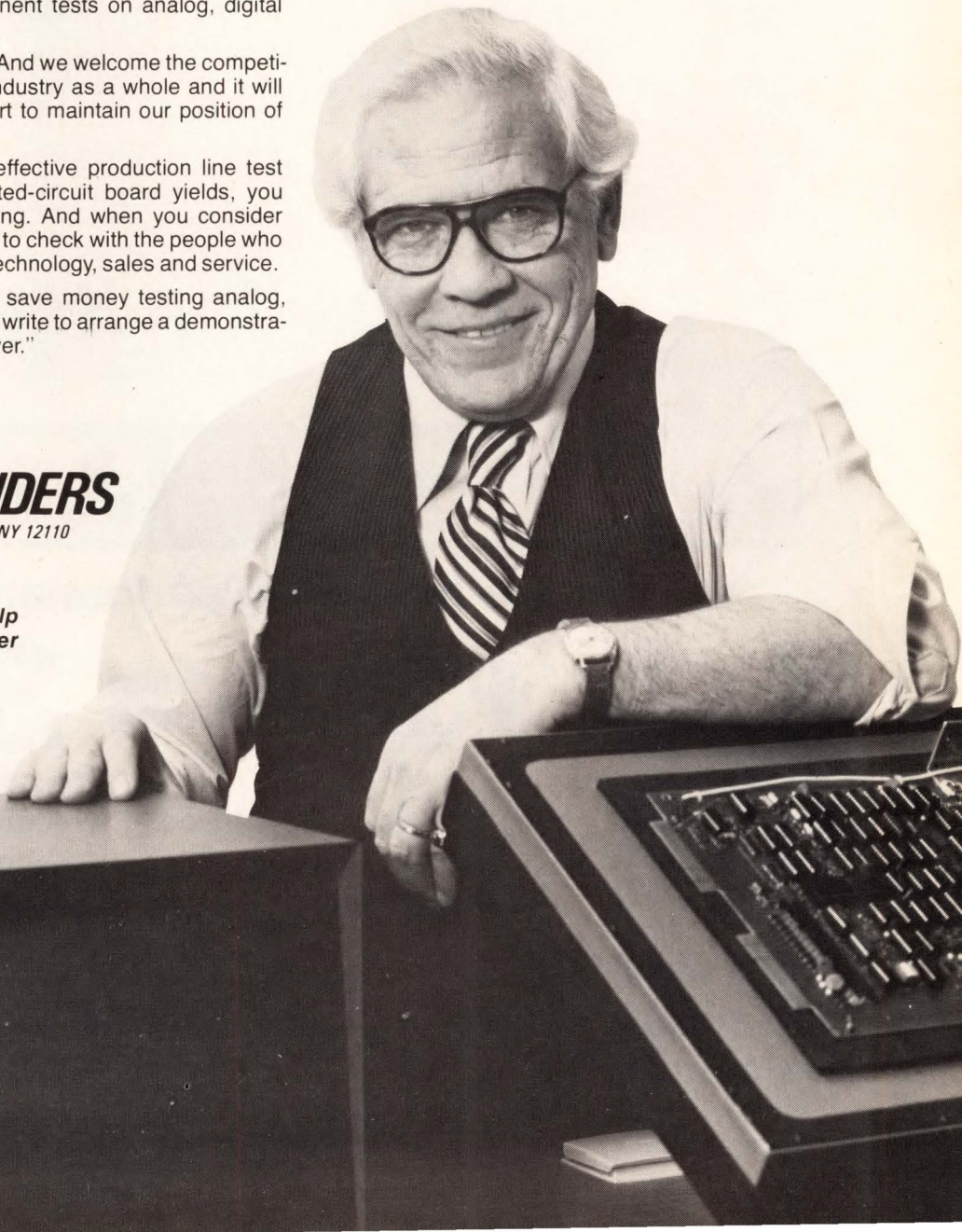

Omnigraphic® Series 2000 X-Y recorders

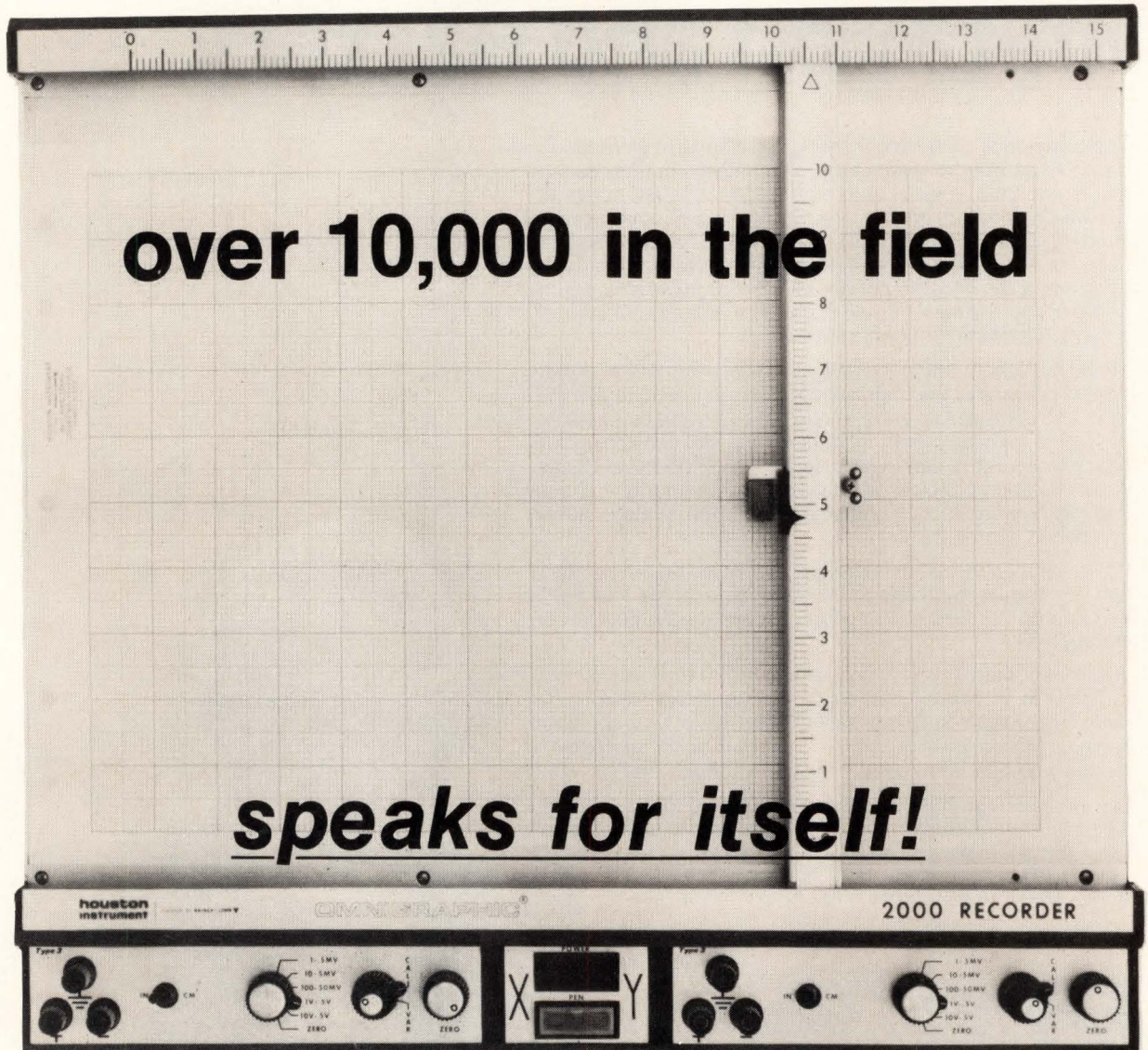

You get the best price/performance possible

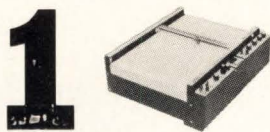

Start with the versatile main frame

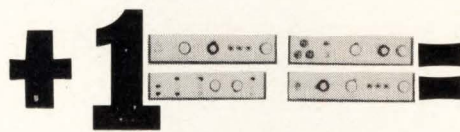

Add your "Designers Choice" from 18 input modules

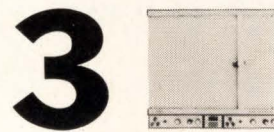

You get an X-Y Recorder with the best price/performance available.

Send for **FREE**
"Designers Choice"
catalog today

® A registered trademark of Houston Instrument

houston instrument

ONE HOUSTON SQUARE (512) 837-2820

EUROPEAN HEADQUARTERS

THE RECORDER COMPANY

(at 8500 Cameron Road) TWX 910-874-2022

Phone 059/277445

DIVISION OF BAUSCH & LOMB

AUSTIN, TEXAS 78753 cable HOINCO

Telex Bausch 81399

Circle 166 for literature
Circle 240 for demonstration

Visit us at Booth #524 at the
Mini-Micro Show in Anaheim, Ca. Dec.6-8

Stackpole Ceramag[®] gives you more of what you buy an inductor core for.

Transformer designs a la Stackpole toroids
Contain no air gaps or efficiency voids.

Need a good Q? Check our cups and our pots.
They'll adjust to your problems, be they ohms,
hertz or watts.

Stackpole ferrite cores, both U and E,
Can take lots of power with a high Curie.

Three vowels to remember: Ceramag E's, U's, and I's
For fluorescent light ballasts and switched mode
supplies.

Our sleeves, baluns, beads help to shut out the sound
From extraneous EMI that is buzzing around.

Stackpole ferrite slugs give car radios strength.
If you're into perm tuning, we're on your wavelength.

And speaking of autos, you will never be sore
Knowing ferrite core sensors watch your carburetor.
Showing up "EGR" on your auto dashboard.

When it comes to TV's, we've got quite a selection.
From CRT circuits for info collection
To round ferrite yokes for TV deflection.

For adjustable tuning and good Q circuitry,
Stackpole threaded cores offer just what you need.
And without even costing an arm and a knee.

If you'd like to devise a test for your peers,
Our name and address are featured right here.
We'll send you our folder to make it all clear
And we never would give engineers a bum steer.
So send us your name and where you are near.

We'll get back to you and we're sure you'll be
pleased with our Ceramag Bulletin 59-103.

Stackpole Carbon Co.
Electronic Components Div.
St. Marys, Pa. 15857

Circle 167 on reader service card

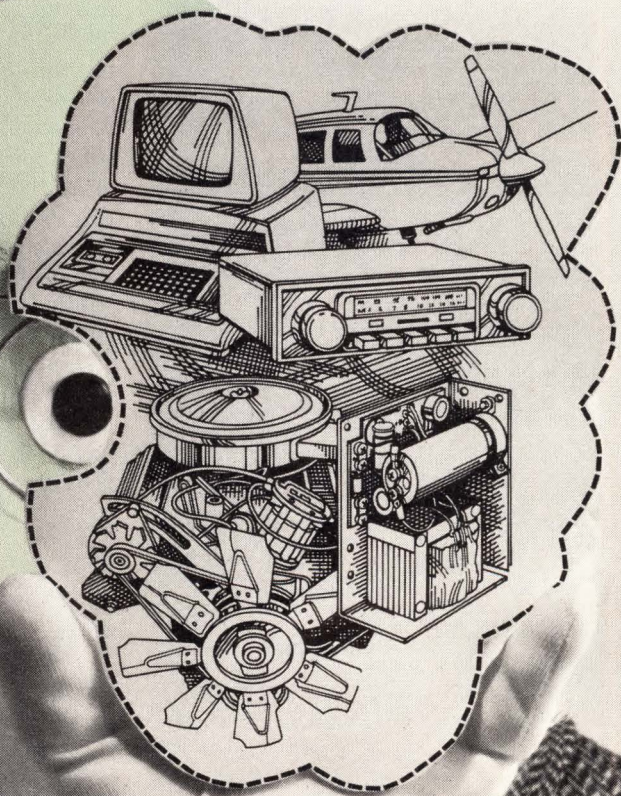
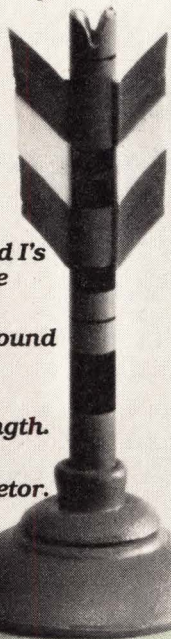

Ceramag. The right ferrite.

 **STACKPOLE**

VAC
VACUUMSCHMELZE

VACUZET®

a semi-hard magnetic alloy with rectangular hysteresis loop for impulse controlled self latching relays.

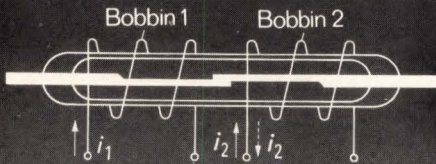

Properties:

- high remanence
- adjustable coercitive force

VACUZET 200 258 655 923

H_c	A/cm	15	30	50	75
B_r	T	1.5	1.45	1.45	1.25
B_r/B_{100}	%	ca. 90			

For data sheet and further information apply to

**VACUUMSCHMELZE
GMBH
6450 HANAU
W.-Germany · POB 109**

New products

Subassemblies

Amplifier built for speed

Hybrid-like op amp
in 24-pin DIP
slews at 2,500 V/ μ s

To meet the special needs of video equipment, Optical Electronics Inc. has designed an operational amplifier that slews at the speedy rate of $\pm 2,500$ volts per microsecond. Moreover, the device is a hybrid-like structure, offering the convenience of an integrated-circuit-compatible package. Designated the model 9909, the unit is especially suitable for the amplifiers used in cathode-ray-tube displays, where high-speed deflection is required for switching from one side of the screen to the other, says Richard Gerdes, Optical Electronics president.

To get the fast slewing, "We use a straightforward technique, simply pumping a lot of current through the device's transistors," he explains. As a result, quiescent power dissipation for the 9909 is rather high—around 1.8 watts. "It takes this kind of power to get the slew rate," notes Gerdes. The transistors are high-

frequency devices with a unity-gain cutoff frequency up around 2 gigahertz, and "they have sufficiently large geometries to take the current and voltage," he adds.

The 9909 comes in a standard 0.6-inch-wide 24-pin dual-in-line package, but the firm builds it with miniature packaged discrete transistors, mounted and interconnected on a small printed circuit. "We went to a 24-pin package for the thermal dissipation it provides," Gerdes says.

Operating from a ± 15 -v supply, the 9909 delivers an output voltage swing of ± 10 v. It is a differential-input unit that may be used in either an inverting or a noninverting configuration. Common-mode rejection is 40 decibels at 100 megahertz, 50 db at 10 MHz and 60 db at 1 MHz as well as at 1 kilohertz.

At a gain of 100, the 9909 has a gain-bandwidth product of 1 GHz minimum. In fact, the unit is optimized for use at gains above 40 db. Below this, it requires external compensation. The company brings out a phase-correction pin for this purpose, permitting the 9909 to be stabilized even down to unity gain. Instead of phase compensation, the user may opt to connect a series RC network between the differential inputs, Gerdes says.

Maximum input bias current for the 9909 is 50 microamperes, and maximum input offset voltage is 100

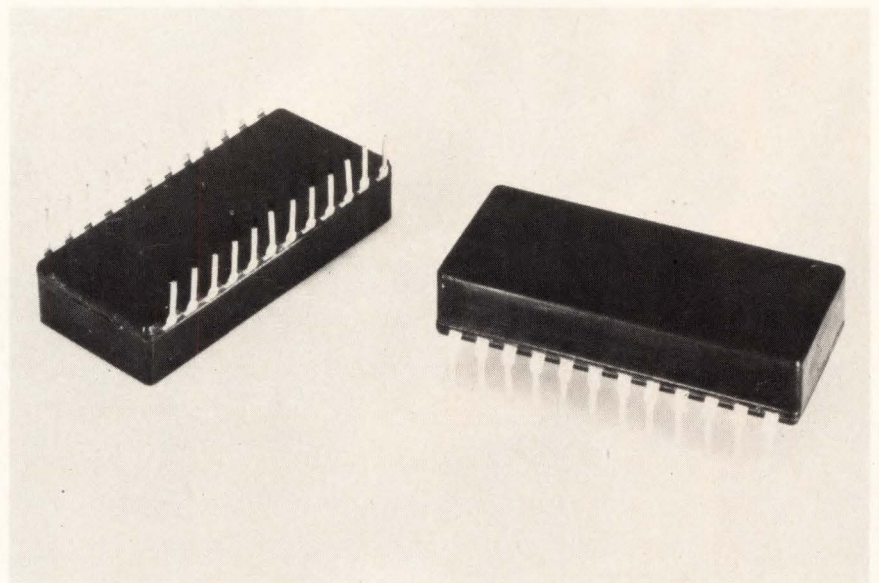

Tomorrow's testing is here!

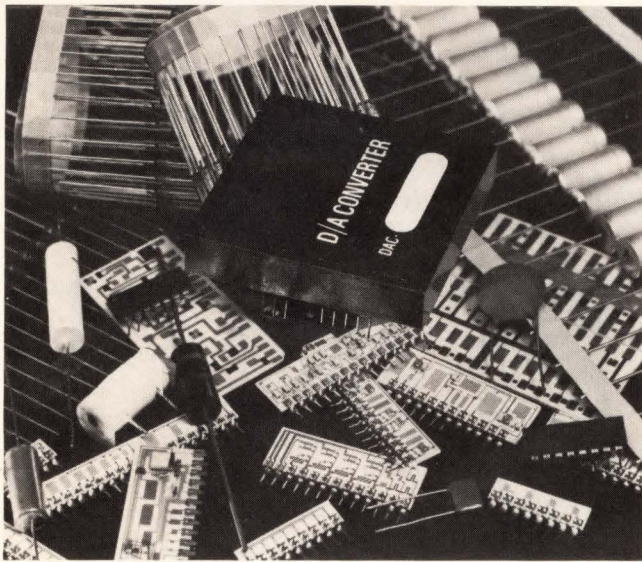

The GR 2230 is testing:

- thick and thin film networks
- hybrid circuits
- discrete components on reels
- sequenced components
- diodes and transistors
- small functional modules/circuits
- switches and relays
- transformers
- hi-rel components
- D/A-A/D converters

In all of these areas:

- production control
- incoming inspection
- quality monitoring
- environmental testing

Components • Networks • Modules Test them all automatically on one tester — GenRad's 2230



Interfaces with a variety of handlers

Automate your testing with a computer-controlled component, network and module tester for under \$20,000.

These days, multi-leaded networks and modules have become so complex, you simply can't get away with sample testing.

Yet in-house or calculator-based test systems are just too slow, and the computer-controlled ones cost an arm and a leg.

But now there's the GR 2230.

At the heart of this compact bench-top system is a small but powerful microcomputer. To give you computer-controlled speed, accuracy and flexibility.

The 2230 will test components, networks, modules, and small PC boards at speeds up to 80 tests per second, measuring to specified limits the performance of each circuit component.

It can be programmed by just about anyone, thanks to its unique English-language macro-instruction keyboard. Programs are then automatically stored on magnetic cards for easy retrieval.

In addition, the system will continuously print out all test data and can be easily interfaced to virtually any device handler.

The GR 2230. A computer-controlled tester you can afford. Now that you can't afford to be without a computer-controlled tester.



GenRad

GE miniature lamps offer you gigantic design advantages.

With 11 new wedge base GE lamps, you have more choices than ever.



Enjoy new design freedom with this expanded line of GE all-glass wedge base lamps. And keep enjoying the inherent benefits of the line: savings in weight, space, time and costs. GE now offers more than 30 wedge base lamps in three sizes: miniature lamps T-3¼ (10 mm diam.) and T-5 (15 mm diam.); subminiature lamp T-1¾ (6 mm diam.). Voltages range from 2.5 V to 28 V. Candlepower from 0.03 to 21 cd.

Use GE wedge base lamps with confidence for indicator, marker and general illumination applications, especially where space is at a premium. You may enjoy lower systems cost than with metal-based lamps and LED's. They're easy to insert and remove; have no soldered connections to corrode or break; and the filament is always oriented the same in relation to the base.

To start saving with GE wedge base lamps now, send for the latest bulletin on GE's expanded line. Order #3-5259R2. It's free.

For whiter, brighter light use GE halogen-cycle lamps.

GE halogen-cycle lamps offer you very high light output from a very small package. They can provide better light efficiency because the bulb doesn't blacken and because of accurate filament placement. Many have uniform bulb tops (no tip).

You get a whiter light than from comparable incandescent lamps because of higher color temperature operation. And they maintain their high initial output level for virtually the life of the lamp.

Because of their lower electrical power requirements, you also save on operating costs vs. comparable incandescent lamps. Some halogen lamps have long design life for low maintenance costs, too.

You can use GE halogen-cycle lamps with confidence when your design needs call for a lot of light in restricted space. For greatly expanded information on GE halogen-cycle lamps, send for your free copy of the new GE bulletin #3-5257-R.

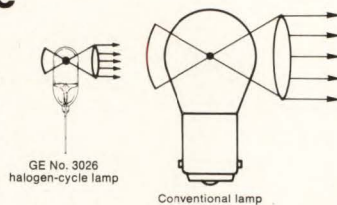

How to order lamp samples and important new free catalogs.

For catalogs and information on how to get lamp samples, call your local GE Miniature Lamp Products Representative or write: General Electric, Miniature Lamp Products Department #3382, Nela Park, Cleveland, Ohio 44112.

GENERAL  ELECTRIC

New products

millivolts, typically only 20 to 30 mv. Of course, the 9909 may be trimmed externally for zeroing its offset. Over the unit's operating temperature range of -55°C to $+85^{\circ}\text{C}$, maximum offset drift is held to 1 mv/ $^{\circ}\text{C}$.

Prices for the device are \$69 for one or two, \$62.50 for three to nine, and \$56 for 10 to 29. Delivery is from stock.

Optical Electronics Inc., P.O. Box 11140, Tucson, Ariz. 85734. Phone (602) 624-8358 [381]

Instrumentation amplifier has gain-setting resistors

With conventional instrumentation amplifiers, the use of external gain-setting resistors unavoidably leads to gain errors because of temperature differences and imperfect tracking between the internal and external resistors in the gain-setting circuit. This problem is eliminated in the MN2200—an instrumentation amplifier with built-in resistors for setting gains of 1, 10, 100, and 1,000. Gains other than these four can still be obtained in the conventional manner.

A second novel feature of the amplifier is its inclusion (as an extra-cost option) of a two-pole, low-pass, Butterworth filter. The filter breakpoint is set by the user with two external capacitors.

Other key specifications include differential and common-mode input impedances in excess of 1,000 M Ω , a full-power bandwidth of 750 kHz at unity gain, and common-mode rejection

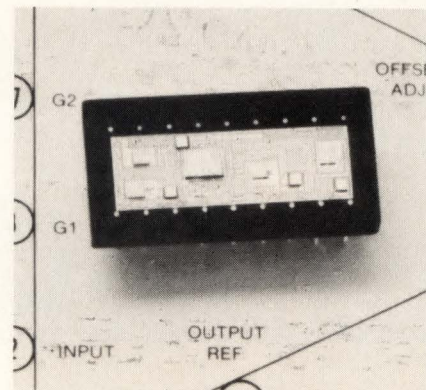

OUR NEGATIVE 5-AMP ADJUSTABLE REGULATOR IS PUTTING A LOT OF 1-AMPS OUT OF WORK.

Throw away the shoehorn! It no longer takes five 1-amp voltage regulators and a handful of components to get to 5 amps. Which means you can get better specs. In less time. Using less room. At less cost.

And get this: The part that makes it all possible, a negative 5-amp adjustable voltage regulator, is available from Fairchild. A major hybrid supplier capable of high volume production.

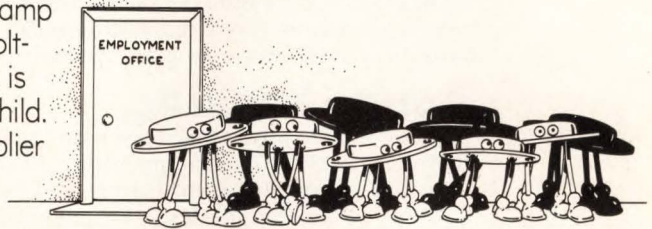

NOT JUST YOUR REGULAR REGULATOR.

Our μ A79HG is a general purpose regulator capable of supplying in excess of 5 amps over a -24 V to -2.2 V output range. It has full thermal overload and short-circuit protection. It's packaged in a hermetically sealed 4-pin TO-3 package that provides 50 W power dissipation.

The regulator consists of a monolithic chip driving a discrete series pass element and short-circuit detection transistors. And that's not all. Our μ A79HG needs no electrical insulator because its case is isolated.

ELECTRICAL CHARACTERISTICS: $T_J = 25^\circ\text{C}$, $I_{OUT} = -2.0$ A unless otherwise specified					
CHARACTERISTIC	CONDITION	MIN	TYP	MAX	UNITS
Input Voltage Range		-40		-7.0	V
Nominal Output Voltage Range	$V_{IN} = V_{OUT} - 5$ V	-24		-2.23	V
Line Regulation	$V_{IN} = -7$ V to -40 V		0.4	1.0	% (V_{OUT})
Load Regulation	$V_{IN} = V_{OUT} - 10$ V, $I_{OUT} = -10$ mA to -5 A		0.7	1.0	% (V_{OUT})
Control Pin Current				3.0	μ A
Quiescent Current	$V_{IN} = -10$ V			5.0	mA
Ripple Rejection	$V_{IN} = -8.5$ V to -18 V $V_{OUT} = -5$ V, $f = 120$ Hz	50			dB
Output Noise Voltage	10 Hz $\leq f \leq 100$ kHz, $V_{OUT} = -5$ V		200		μ V
Dropout Voltage	$I_{OUT} = -5$ A		2.0		V
Peak Output Current	$V_{IN} = -10$ V		8		A
Control Pin Voltage (Reference)	$V_{IN} = -10$ V	-2.35		-2.11	V

SO MUCH FOR SO LITTLE.

With all this performance, you'd expect a large price tag. But our μ A79HGK costs only \$7.15 in quantities of 100. That's about 30% less than equivalent hermetic 1-amp regulators.

To find out more about our negative 5-amp adjustable voltage regulators (or any of our other hybrids), write or call your Fairchild sales office, distributor or representative today. Or, use the number at the bottom of this ad to call our Hybrid Products people direct. Fairchild Camera & Instrument Corp., 464 Ellis St., Mountain View, CA 94042. Tel: (415) 962-3771. TWX: 910-379-6435.

FAIRCHILD

**CALL US ON IT.
(415) 962-3771**

Communications 78

Communications Equipment and Systems

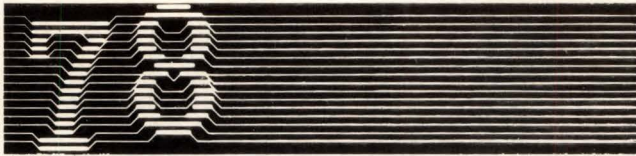

National Exhibition Centre, Birmingham, England.
Tuesday 4-Friday 7 April 1978

You are invited to Communications 78

Communications 78 is the world's leading exposition for selling communications equipment and systems, providing an international focal point for the latest technological advances in the fields of PTT telecommunications, fixed and mobile radio communications and defence communications.

Active backing

Trebled in size since the last event in 1976, Communications 78 is being supported by more than 200 international exhibitors and has the active backing of the International Telecommunication Union (ITU), representing the interests of 153 governments; the British government through the Ministry of Defence, the Home Office and the British Overseas Trade Board; Post Office Telecommunications; the Electronic Engineering Association (EEA) and the Telecommunication Engineering and Manufacturing Association (TEMA).

Integral conference

The integral conference is being organised by The Institution of Electrical Engineers (IEE) in association with the Institution of Electronic and Radio Engineers (IERE), the UKRI section of the Institute of Electrical and Electronics Engineers (IEEE) and the IEEE Communications Society.

Communications 78 is being held for the first time at the National Exhibition Centre, Birmingham—the UK's premier exhibition complex—from Tuesday 4 April to Friday 7 April 1978. The exhibition will be open daily from 09.30-18.00 hrs. (17.30 hrs. on last day).

Admission to the exhibition is free to bona fide users and specifiers of communications equipment and systems. The coupon below may be presented as an admission ticket to Communications 78 or, if you require more detailed information, please complete and send it to: Tony Davies Communications, c/o Industrial and Trade Fairs Ltd., Radcliffe House, Blenheim Court, Solihull, West Midlands B91 2BG, England.

Please send me details of

- the exposition
the conference

Name _____

Position _____

Company _____

Address _____

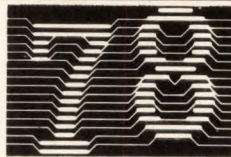

11

New products

tion in excess of 80 db. The initial input offset voltage is less than 200 μV , and this drifts less than 6 $\mu\text{V}/^\circ\text{C}$ at unity gain and 2 $\mu\text{V}/^\circ\text{C}$ at a gain of 1,000.

The MN2200 operates from -25°C to 85°C and sells for \$59 each in hundreds. Housed in an 18-pin hermetic dual in-line package, the amplifier is available from stock to four weeks.

Micro Networks Corp., 324 Clark St., Worcester, Mass. 01606. Phone John F. Munn at (617) 852-5400 [383]

Analog-to-digital converter resolves 16 bits in 80 μs

Designed for airborne and other critical applications, the ADC 2000/2100 series analog-to-digital converter is a 16-bit device with a conversion time of 80 μs . It is accurate to within 0.004% of full scale and linear to within 0.002% of full scale. Maximum temperature coefficient of gain and zero is 5 ppm/ $^\circ\text{C}$ (2.5 ppm and 1.5 ppm optional), and maximum temperature coefficient of linearity is 0.9 ppm/ $^\circ\text{C}$ (0.6 ppm and 0.3 ppm optional).

In addition to its outstanding accuracy, the 2000/2100 features a power consumption of only 500 mw.

The ADC 2000 series units are printed-circuit boards that measure approximately 5 by 4.5 by 0.5 inches. Units in the ADC 2100 family come in cases with dimensions of 3 by 4 by 0.4 in. Prices start at \$725 each in small quantities.

Phoenix Data Inc., 3384 West Osborn Rd., Phoenix, Ariz. 85017. Phone Srinil Iyer at (602) 278-8528 [384]

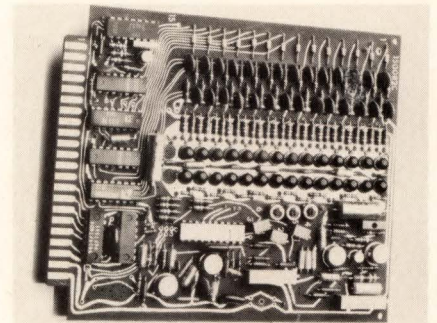

A Line for All Reasons

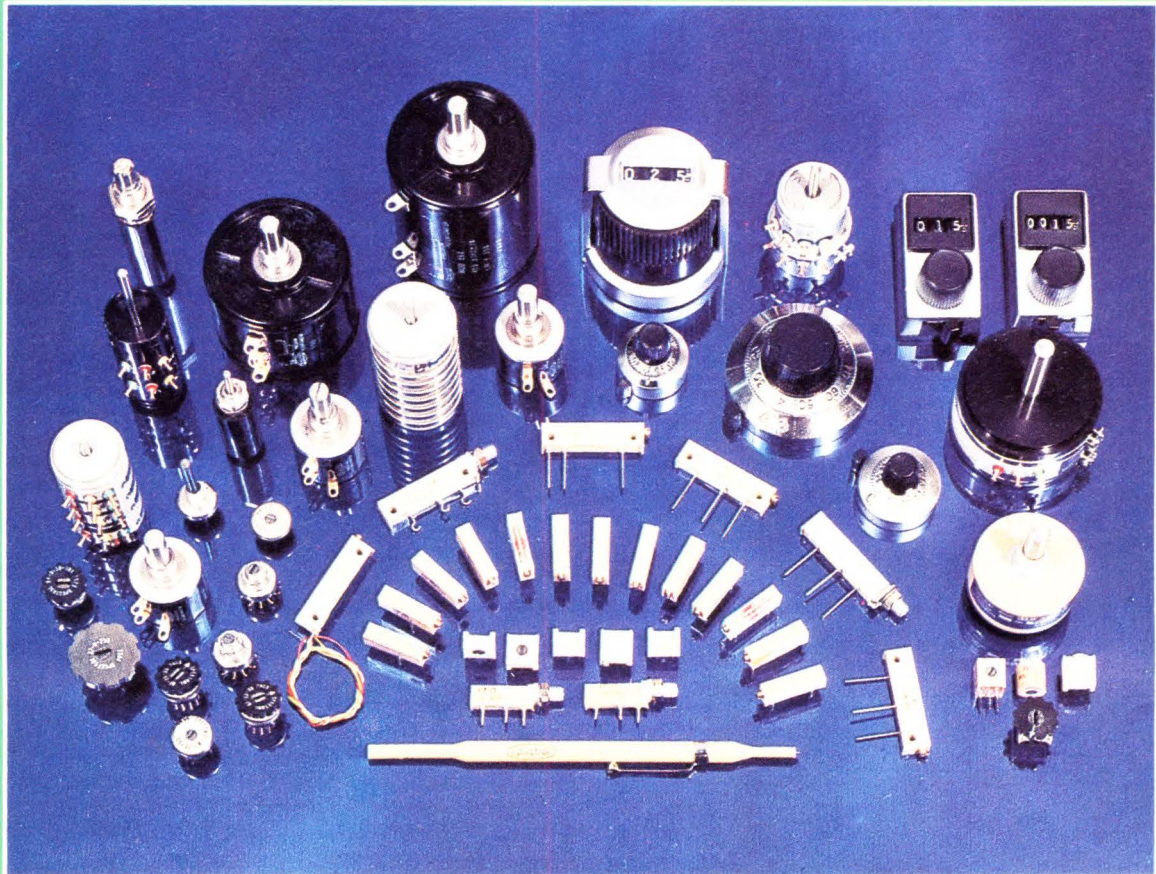

Pots, Dials, Trimmers, Switches

Need standard or special precision pots for industrial or military applications? Turns-counting dials for your front panels? Trimmers for your minis, or miniature rotary switches for your peripherals? Whatever you need—we have a line for all reasons. In fact, the only thing we don't have are high prices. For more information on any of our four lines of "quality components", call or write.

Spectrol

SPECTROL ELECTRONICS GROUP

UNITED STATES Spectrol Electronics Corporation 17070 E. Gale Avenue, City of Industry, Calif. 91745, U.S.A. • (213) 964-6565 • TWX (910) 584-1314

UNITED KINGDOM Spectrol Reliance Ltd. Drakes Way, Swindon, Wiltshire, England • Swindon 21351 • TELEX: 44692

ITALY SP Elettronica spa Via Carlo Piscane 7, 20016 Pero (Milan) Italy • 35 30 241 • TELEX: 36091

Circle 173 on reader service card

PS-48 Thermal Printer

The PS-48 is a 48-column, reliable Teletype alternative with a minimum of mechanical parts and electronic components. It features Mostek's F8/3870 single-chip microprocessor as an interface and controller.

This versatile interface will operate the printer by jumper option in any of the following modes:

- TTL parallel
- TTL serial
- RS232C serial
- 20 mil loop serial

Key features include:

- Quiet, clean — no ribbons or ink
- Thermal paper now down to \$3 per 164' roll
- Throughput rate — 24 characters/second
- Upper/lower case 96 ASCII characters
- Signalling rates —
Serial mode — 110 or 300 Baud
Parallel mode — up to 960 characters/second
- For applications over 48 columns, automatically prints on next line

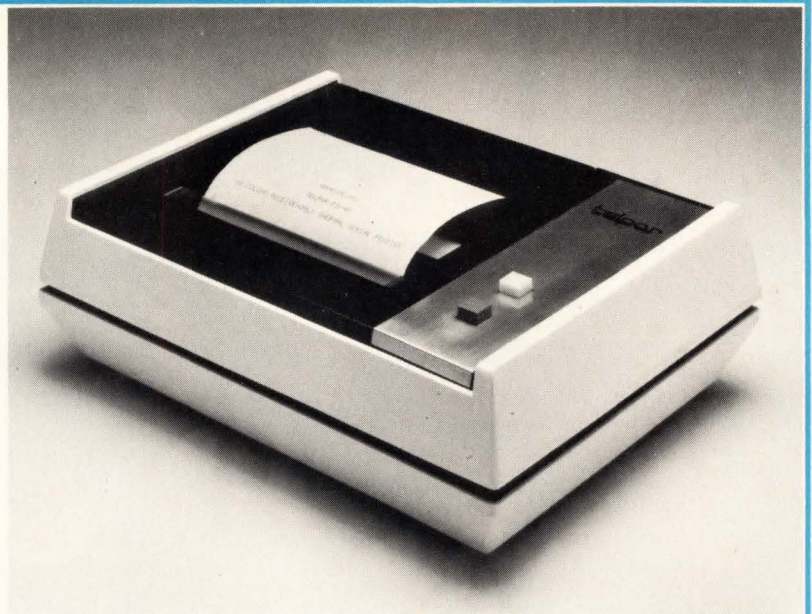

PS-48 (Receive-Only version)\$666
Paper roll (5 1/2" x 164')\$ 3

Delivery — One week ARO, F. O. B. Addison, Texas.

Printing mechanism with or without interface available on OEM basis.

telpar, inc.

For more information contact: Dick Hanschen, (214) 233-6631.
4132 Billy Mitchell Road, Box 796, Addison, Texas 75001.

Circle 174 on readerservice card

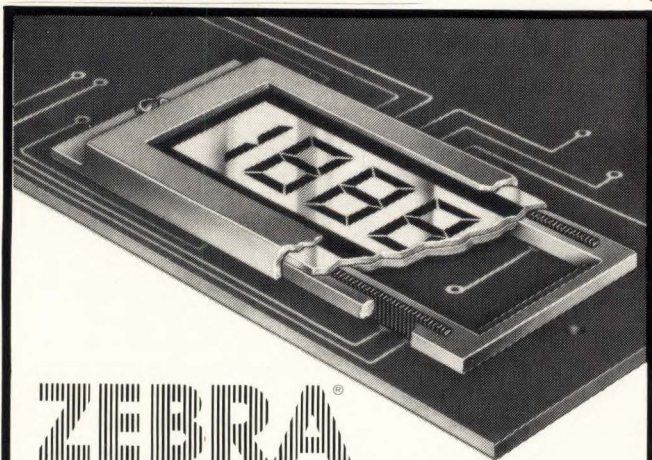

ZEBRA®

LCD CONNECTOR FLAT MOUNT DUAL INLINE CONDUCTIVE ELASTOMERIC CONNECTOR

- Solderless connector assembly for 2" dual in-line LCD's eliminates the need for metal clips
- Provides vibration and shock protection
- Gas tight seal is created • Zero insertion force • Easily installed and replaced.

Send for Connector Catalog
ECKNIT™

EASTERN DIVISION — 129 DERMODY STREET, CRANFORD, N. J. 07016
WESTERN DIVISION — 427 OLIVE STREET, SANTA BARBARA, CA. 93101



Circle 242 on reader service card

REED RELAYS — NO DELAYS

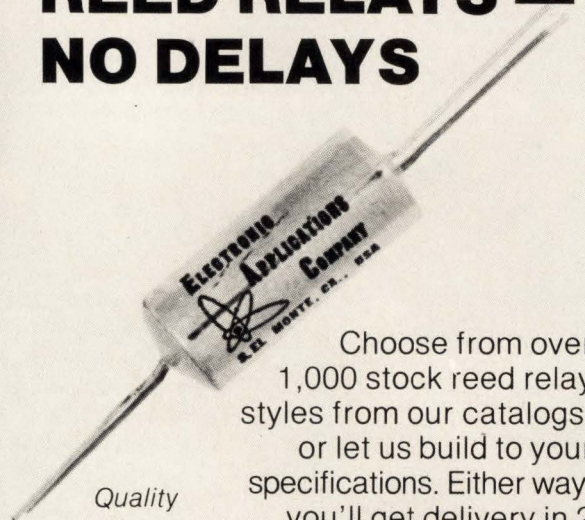

Quality
since
1959

Choose from over 1,000 stock reed relay styles from our catalogs, or let us build to your specifications. Either way, you'll get delivery in 2 weeks for thousands, and sooner for smaller quantities. And at good prices.



Electronic Applications Company
4918 Santa Anita Avenue
El Monte, CA 91734

Telephone:
213/442-3212

Circle 243 on reader service card

Safety. Gould Brush Recorders have it.

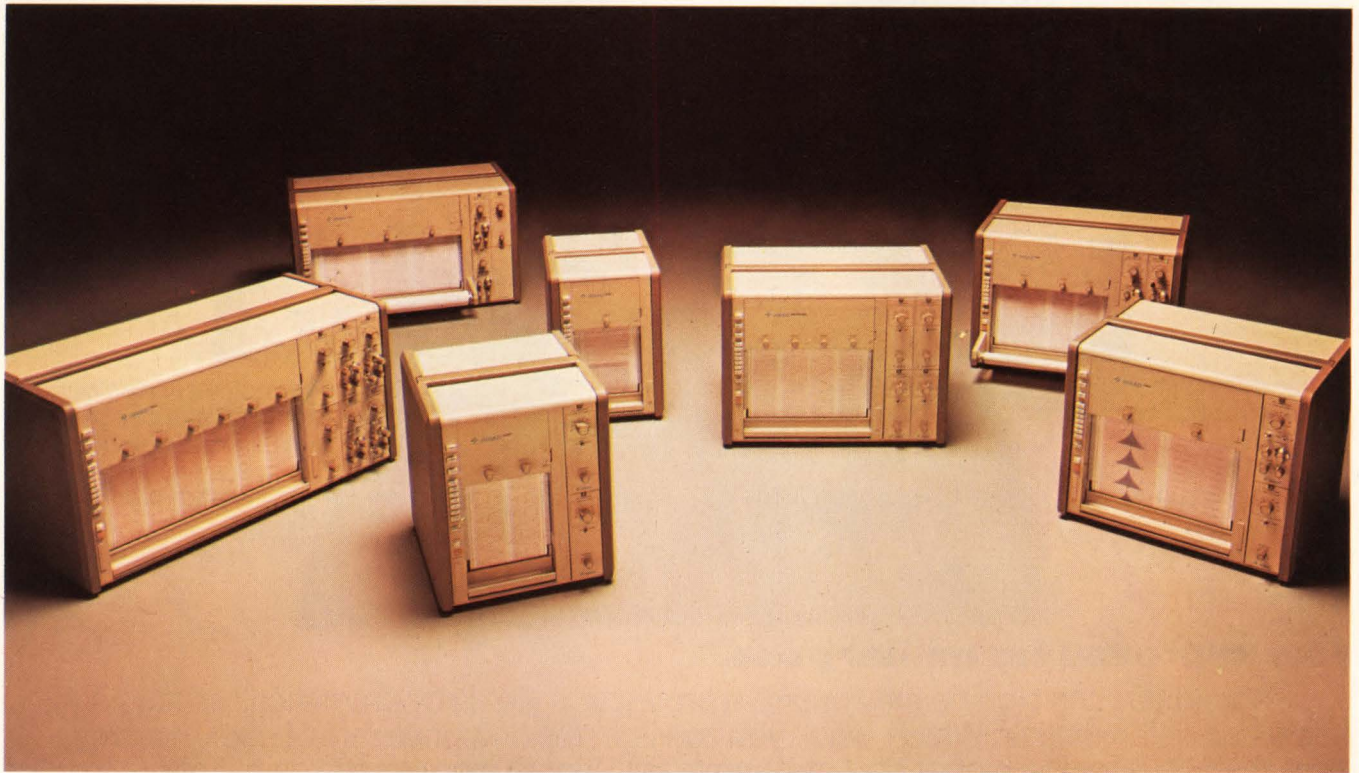

With UL 544 Listing.

The Gould Brush 2000 Series of direct writing recorders are Underwriters Laboratories Listed under U.L. 544 for professional medical equipment. They are listed for all channel configurations for both patient care and medical research application.

This extra measure of safety combines with features such as superior resolution of 99.65% linearity over the entire

channel width, uniform trace width at all writing speeds, pressurized fluid writing systems for smudge free traces and reliability through a proven modular design.

Channel choices range from 1 to 8 and the U.L. Listed signal conditioners fit every model in the 2000 Series. The Series 2000 is as versatile as your needs.

You get more with Gould

Brush 2000 Series Recorders. For details on the oscillographic recorders you should be using contact: Gould, Instruments Division, 3631 Perkins Ave., Cleveland, Ohio 44114 or Gould Allco S.A., 57 rue St. Sauveur, 91160 Ballainvilliers, France.

**FOR BROCHURE, CALL
GOULD TOLL FREE AT
(800) 325-6400 EXT. 77
In Missouri: (800) 342-6600.**

 **GOULD**

Circle 175 on reader service card

POLYIMIDE VS. EPOXY

Kerimid®601

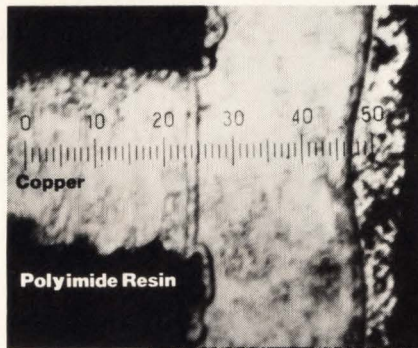

After drilling and soldering extreme magnification shows no resin smear or delamination interrupting circuitry.

Epoxy

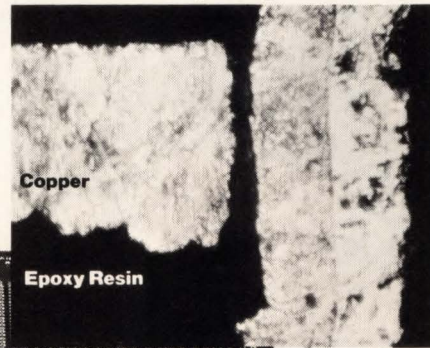

After drilling and soldering extreme magnification shows smear and delamination causing circuit malfunction.

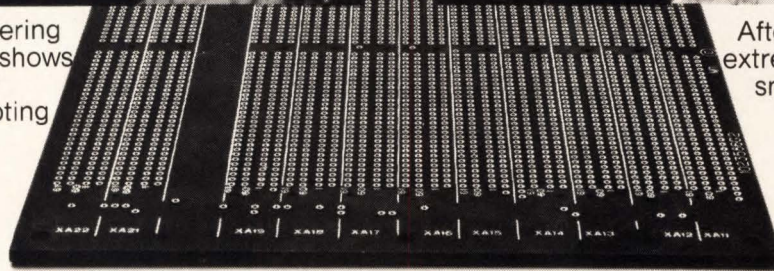

Now approved for military use.*

Kerimid 601 can significantly improve production yields by dramatically reducing smear and delamination. Which, when you consider the defective rate of epoxy boards, more than pays for the higher cost of Kerimid 601. Not to mention the gain it offers to your reputation for reliability in meeting promised delivery dates and in ultimate in-use functioning. In fact, one customer of ours hasn't rejected one circuit board due to smear or delamination in three years.

Kerimid 601 makes all this possible because it brings to circuit packaging the twin advantages of high heat resistance (4-500°F) and epoxy processability (355°F/200Psi). Additionally, void-free laminates offer improved characteristics over epoxies in z-dimensional stability and moisture resistance.

We think the combination of production and performance advantages offered by Kerimid 601 makes it well worth your investigation.

For more information, direct inquiries to: Rhodia Inc. Specialty Plastics Department, P.O. Box 125, Monmouth Junction, New Jersey 08852 (201) 846-7700.

Rhone-Poulenc, 22 Av.
Montaigne, Paris-8e,
France 256-4000.

KERIMID® 601 
A SUBSIDIARY OF RHÔNE-POULENC

* MIL P-13949/10 Amendment 2; MIL P-55617 revision B; MIL G-55636 revision B.



The right connection.

CAMBION electronic components are known around the world for superb quality, dependability and durability. There are many reasons. CAMBION precision electronic components and other CAMBION products are much more than the prime metals and materials that go into them. More than excellent design and engineering. More than stringent quality control and the highest standards in the industry. More than on-time delivery. More than the experience of satisfying OEM needs for over 30 years.

More than the positive motivation of a dedicated, responsible on-line team of workers.

CAMBION products are the sum of all these parts. That's why you get so much from CAMBION. So much goes in. That's why every CAMBION product is the right connection for *your* products and *your* customers' satisfaction.

And that's how we can afford to guarantee every CAMBION product.

Write today for free, full-line catalogs of the right CAMBION connections for you.

CAMBION[®]

Cambridge Thermionic Corporation
445 Concord Avenue, Cambridge, MA 02138

CUSTOM CRYSTAL OSCILLATORS

Call Vic Gill (714) 759-2411

Or send for new brochure:
500 Superior Ave., Newport Beach, CA 92663

HUGHES

HUGHES AIRCRAFT COMPANY

MICROELECTRONIC PRODUCTS DIVISION
Circle 244 on reader service card

CUSTOM HYBRIDS

Call Frank Albertson
(714) 759-2411

Or send for new brochure:
500 Superior Ave., Newport Beach, CA 92663

HUGHES

HUGHES AIRCRAFT COMPANY

MICROELECTRONIC PRODUCTS DIVISION
Circle 245 on reader service card

TRIPLE TESTED THRIFTMETERS

Now with lower prices
—AND plug-in components
—AND unichip electronics



PM-349 \$47

Lowest priced Thriftmeter.

PM-350 \$59

With plug-in components.

Features Include:

- 3-1/2 digits.
- Accuracy is $\pm(0.05\%$ Rdg. + 0.05% F.S.).
- $\pm 0.2V$, $\pm 2V$, $\pm 20V$, $\pm 200V$ or $\pm 1000V$ range.
- Auto zero and auto polarity.
- 5 vdc power @ 1 W.
- Large 0.3" LEDs.
- Small size: 1" H x 2.5" W x 3.25" D.
- Protected input.
- Unichip construction.



Non-Linear Systems, Inc.

Originator of the digital voltmeter.

Box N, Del Mar, California 92014

Telephone (714) 755-1134 TWX 910-322-1132

178

Circle 178 For PM-349
Circle 264 For PM-350

New products

Industrial

IC sensor checks temperature

Driven by a dc supply,
device gives an output current
proportional to temperature

Pointing out that no other physical parameter is monitored as frequently as temperature, engineers at the Semiconductor division of Analog Devices Inc. expect their integrated-circuit temperature sensor to make a big dent in applications now dominated by thermocouples, thermistors, and resistance temperature detectors.

The AD590 is a two-terminal device that produces an output current proportional to absolute temperature when driven by a dc supply voltage between 4 and 30 v. The sensor delivers an absolute accuracy to within 1°C over a range of -55°C to $+150^\circ\text{C}$. Goodloe Suttler, product marketing engineer at the division in Wilmington, Mass., says he recognizes that this temperature

range is a great deal less than that of the more traditional temperature sensors, but he maintains that the circuit will outperform thermocouples and thermistors in terms of linearity and is substantially less expensive than RTDs.

The AD590 is laser-trimmed at the wafer stage to produce an output of $298.2 \mu\text{A}$ at 25°C . The output changes $1 \mu\text{A}/^\circ\text{C}$ from that point.

Three models are available. The high-precision AD590L, which sells for \$7.95 each in lots of 100 or more, is guaranteed to a calibration accuracy that is within $\pm 1^\circ\text{C}$ at 25°C . The AD590K at \$3.95 offers accuracy to within 2°C . The AD590J's accuracy is to within 5°C . "The 590 is calibrated to absolute temperatures," Suttler stresses, "and that calibration is all done for the user when he gets the device. No external devices are required to linearize the output, as is necessary with thermocouples."

Suttler and product marketing engineer Rich Frantz expect the 590 to find its way into such applications as industrial control probes for air-temperature sensing and process control and into digital-thermometer designs in medical, consumer, and automotive applications. Suttler

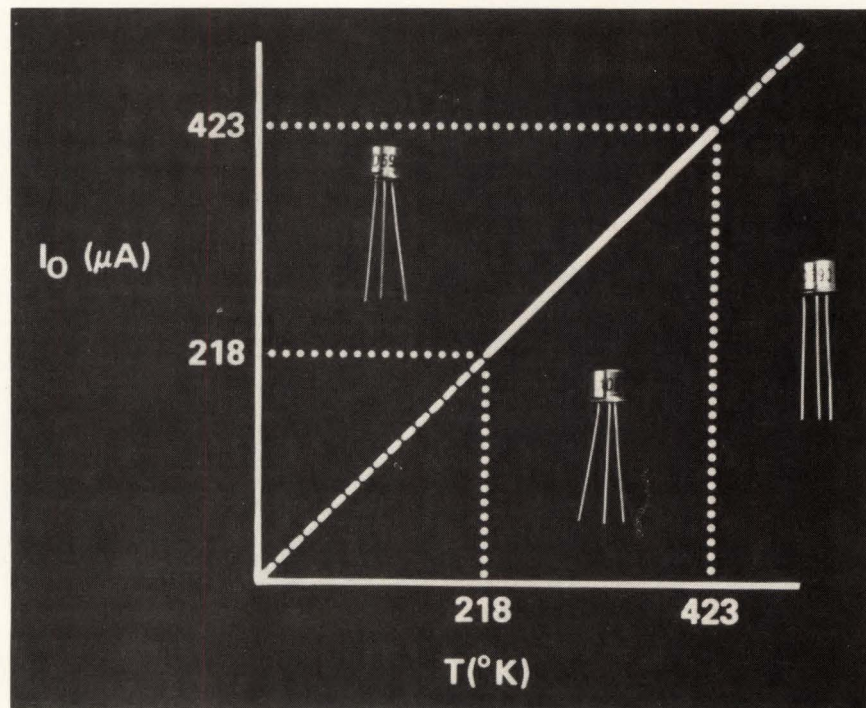

When you need LEDs or more than LEDs...



Dialight is the first place to look. We can help you do more with LEDs... because we've done more with them.

Discrete LEDs come in a variety of sizes, shapes, colors (red, yellow, green in clear or diffused), with or without built-in resistors.

Low cost logic state fault indicators for trouble shooting complex circuits. Designed for close density PC board mounting.

High-brightness bi-color LEDs (red/green) suitable for go/no-go situations. Designed with unique

lenses for the extra visibility you'll want for your most critical applications.

Snap-in mounting LED indicators reduce labor cost. Available in red, yellow or green with or without built-in resistors.

Whatever you need in LEDs, Dialight's probably got it already. For your free 60-page selector guide and listing of our nationwide stocking distributors, contact us today.

DIALIGHT
A North American Philips Company

Dialight meets your needs.

Dialight, 203 Harrison Place, Brooklyn, N.Y. 11237 (212) 497-7600

Circle 179 on reader service card



SAY HELLO TO OUR MODEL 101. AND GOODBYE TO CALIBRATION HASSLES.

Meet a new kind of instrumentation portable, one so self-contained that all the calibration equipment you'll ever need is built right in.

Just press AUTO TEST and Honeywell's new Model 101 checks itself and tells you what, if anything, needs adjustment. You can do a complete calibration in about half the usual time, and do it with only a screwdriver or simple tweaking tool.

But don't think of the 101 as just a more portable portable. Because it's also a more advanced lab system.

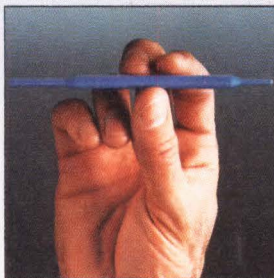

One that comes with up to 32 data channels — wideband or intermediateband, speeds from 15/16 to 120 ips, programmable selective track sequencing, and large reels for up to 32 hours of recording time.

Compare the Model 101 with your present tape system and see what a difference a microprocessor makes. For details, or for a demonstration of the Model 101, contact:

Darrell Petersen, Honeywell Test Instruments Division, Box 5227, Denver, CO 80217. (303) 771-4700.

WE'LL SHOW YOU A BETTER WAY.

Honeywell

CUSTOM BIPOLAR LSIs

Call Dennis Olson (714) 759-2411

Or send for new brochure:
500 Superior Ave., Newport Beach, CA 92663

HUGHES

HUGHES AIRCRAFT COMPANY

MICROELECTRONIC PRODUCTS DIVISION

Circle 247 on reader service card

CUSTOM CRYSTAL FILTERS

Call Vic Gill (714) 759-2411

Or send for new brochure:
500 Superior Ave., Newport Beach, CA 92663

HUGHES

HUGHES AIRCRAFT COMPANY

MICROELECTRONIC PRODUCTS DIVISION

Circle 248 on reader service card

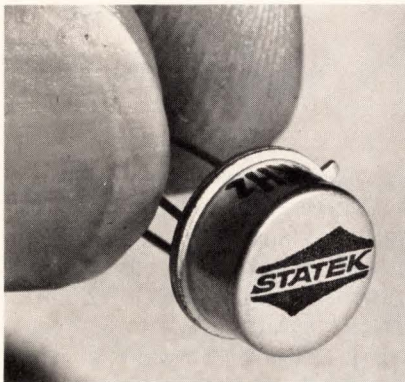

Low Cost Quartz Crystals

Use Statek 10 to 300 kHz quartz crystals in TO-5s... they eliminate count down for oscillators, filters, tone generators, timers... They're rugged, accurate & resistant to high vibration and shock. Prices low as \$1.70 ea. in 1000 qty. Send your written application & we'll send you a sample. Call or write for literature. Details in Gold Book and EEM.

STATEK CORPORATION
512 N. Main
Orange, California 92658
Telephone: (714) 639-7810
TELEX 67-8394

Circle 246 on reader service card

New products

adds that the low power consumption of 1.5 mw with a 5-v supply at 25°C, the high-level output, and the small two-terminal package make the 590 ideal in remote-probe applications as well. In that use, it would replace a thermocouple and be insensitive to voltage drops over long lines because of its high-impedance current output.

The device will be offered initially in a TO-52 metal can or in chip form for hybrid applications. A miniature ceramic-packaged version will follow later. Delivery is from stock.

Analog Devices Semiconductor, 829 Woburn St., Wilmington, Mass., 01887. Phone Jeff Riskin at (617) 935-5565 [371]

Pressure transducer has full-scale range of 1 psid

Designed to measure differential pressures as low as 1 pound per square inch full scale, the model GS-135 uses a capsule-type sensor to obtain terminal-error-band errors of 1.5% of full scale. This low error, combined with a linear variable differential transformer output circuit permits the measurement of pressure changes as small as 0.001 psi.

Built-in dc-to-dc conversion circuitry allows the GS-135 to be connected directly to any dc supply in the range from 9 to 12 v dc. The high-level 0-to-3.5-v dc output signal is electrically isolated from all other voltage sources and can be connected to any type of readout or control equipment. The unit has a time constant of 20 milliseconds—that is,

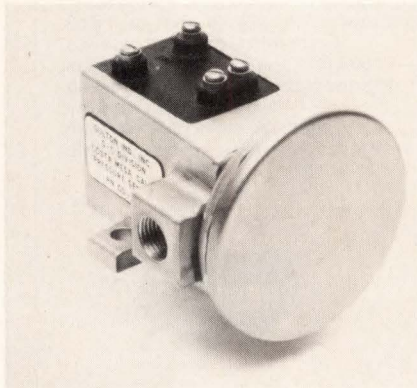

POWER μ P

with SCI 

Increase your system reliability...

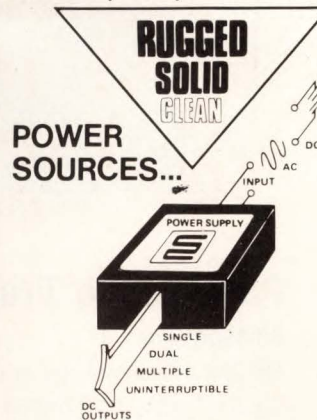







Designed for YOUR application:

- μ P's and Memory
- Logic and Analog—A/D/A
- Peripherals
- Medical

We not only listen — we respond! That's why our product line gives you the widest choice of AC/DC, DC/DC and UNINTERRUPTIBLE POWER SUPPLYS®.

Look What's Available . . .

-  **OUTPUTS:**
From 3.6 to 1000Vdc;
Singles, Duals, Multiples
-  **INPUTS:**
AC . . . 12 to 265Vac @
47Hz to 1KHz
DC . . . 3.6 to 90Vdc
UPS . . . 6 to 24Vdc
-  **PERFORMANCE:**
Reg . . . 5% to 0.005%
-  **PRICE:**
Low Cost/High Value
-  **DELIVERY:** Same day
shipment for most models
-  **RELIABILITY:**
MTBF's > 150,000 Hours

Value-Loaded Products From
Your NO. 1 SOURCE. Get
Complete Information FAST!
Circle the number for our new
1977 FREE CATALOG.



**SEMICONDUCTOR
CIRCUITS, INC.**

POWER SOURCES DIVISION

306 RIVER ST., HAVERHILL, MA 01830
TEL. (617) 373-9104, TWX. 710-347-0269

Circle 181 on reader service card 181

MODEL 612



Paper Tape Transmitter

50-9600 baud
RS 232 / Current loop or parallel outputs available
5-8 level tape, 7-11 frames per character
Stops and starts on character at all speeds
Uses manual control or x-on, x-off
90-260 volt, 50-60 Hz power
Even or odd parity
Desk top or rack mount

Addmaster Corporation
416 Junipero Serra Drive San Gabriel, California 91776
Telephone: (213) 285-1121
Circle 249 on reader service card

New products

its output will change by 63% of an input step change within 20 ms.

Gulton S-C-D, 1644 Whittier Ave., Costa Mesa, Calif. 92627. Phone Tony Trafford at (714) 642-2400 [376]

Surface thermocouples have large contact areas

A line of thermocouples for external surface applications combine low mass with large contact area. The units are offered in two styles: one has exposed flat-ribbon elements, the other has a thin stainless-steel tab brazed to the sensing tip. Both types can be attached to any wall by common cements, epoxy resins, clamps, small screws, or even weld-

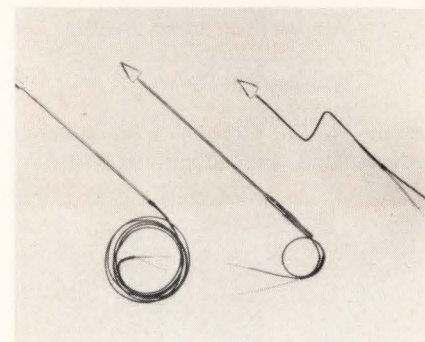

ing. Applications include measuring the temperatures of textiles, clothing, thin walls, and pipelines. Units in the series are available with calibrations that go up to 2,000°F. Prices range from \$24 to \$34 each. Nanmac Corp., 9-11 Mayhew St., Framingham Centre, Mass. 01701. Phone J. Nani-gian at (617) 872-4811 [373]

Low-cost double-make relay switches 30 A

The series 45 power relay is available in two versions. The single-pole double-make unit is rated at 30 A (12 v dc or 120 v ac), which corresponds to a 120-v ac rating of 1 horsepower and a 240-v ac rating of 1.5 hp. A single-pole double-throw version is also offered. Its current rating is 15 A and its two corresponding horsepower ratings are 1

HAVE A FERRITE DELIVERY PROBLEM?



...LOOK TO PERMAG

With Permag supplying application - rated Indiana General Corp. Ferramics,™ you'll always get exactly what you need. Complete fabricating facilities. Prototype quantities available. Plus, engineering assistance, field testing. Prompt 24-hour delivery. Extensive stock of ferrite parts at all locations. New catalog available.



Consult your Yellow Pages for address and telephone number of Permag near you.

✓ Check your system's output.

If it's anything like one of these, investigate the HP display that makes your system look its best.

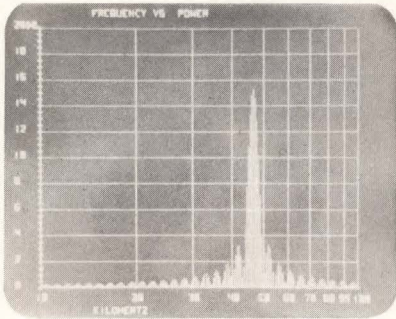

Spectrum Analysis

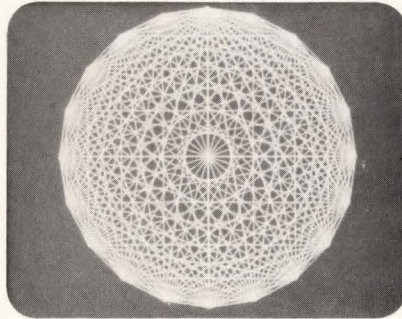

Computer Graphics

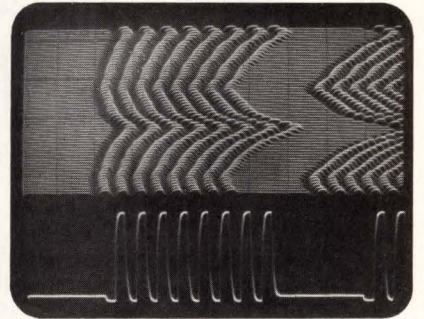

Vibration Analysis

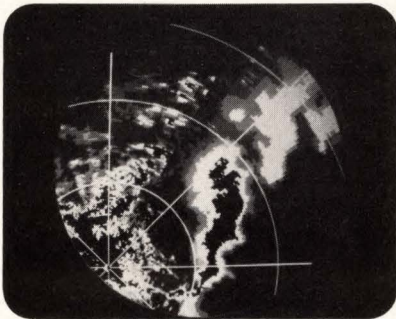

Weather Radar

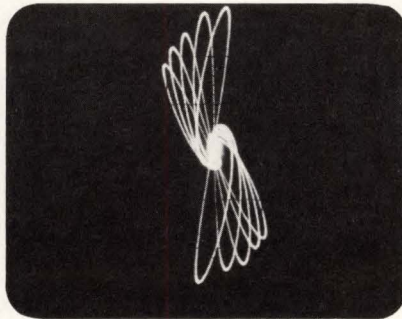

Non-destructive Metal Testing

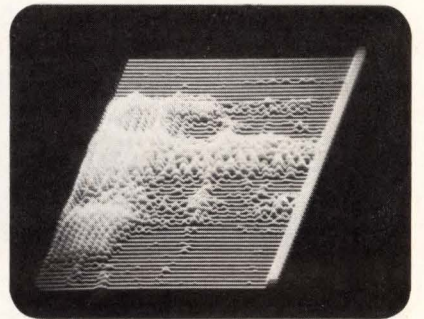

Frequency/Amplitude/Time Analysis of Speech

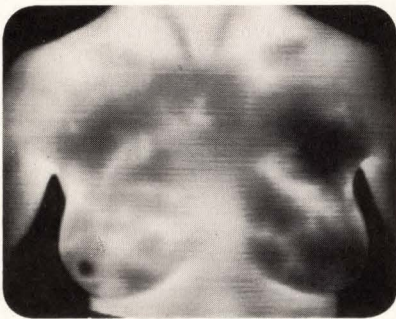

Medical Thermography

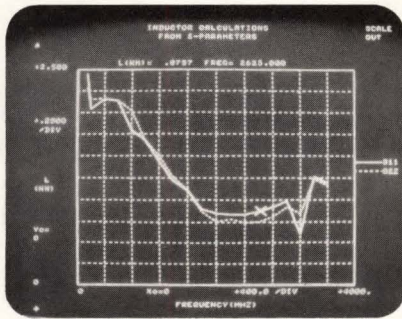

Automatic Test Systems

Mine is different, try this

Check your system's output. Then clip your business card or other identification to this ad and mail to Hewlett-Packard. We'll send display data pertinent to your OEM system needs...large screen or small. HP's displays, with a variety of CRT and electronic options, can meet your need for U.L. listings, fast writing speed, storage, variable persistence, high resolution, and more. And HP provides worldwide after-sales support tailored to your needs. Mail this ad today, or call your local HP field engineer.

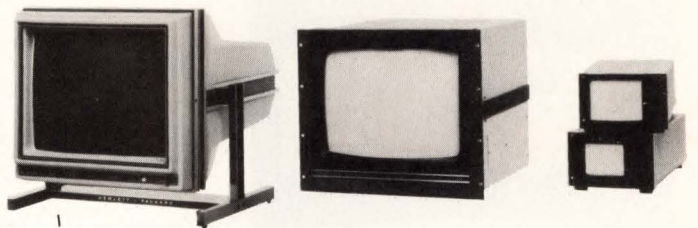

HEWLETT *hp* PACKARD

Box 2197, Colorado Springs, CO 80901, Dept. 233

For assistance call: Washington (301) 948-6370, Chicago (312) 255-9800, Atlanta (404) 955-1500, Los Angeles (213) 877-1282

NOW measure AC, DC, and AC on DC CURRENT
without
breaking
the circuit



Bell Model 1776 Digital Current Meter with non-contact, clamp-on probe does it!

Current measurements are faster, easier and safer. Utilizing Hall effect probes, the 1776 introduces practically no disturbance into the measured circuit. It can measure currents ranging from DC to 5 kHz.

- 3½-Digit Readout
- Peak—Read—Hold
- Three Current Ranges
1000A, 100A, 10A (Resolution to 10 mA)
- Fully Portable
Operates on 117VAC or rechargeable integral batteries.

Request complete information on this unique instrument for use in troubleshooting, R & D and maintenance.



Circle 184 on reader service card

High-Accuracy
Phase
Meters
 0.5 Hz to 2 MHz
 Digital or meter
 readouts
 As low as \$1150

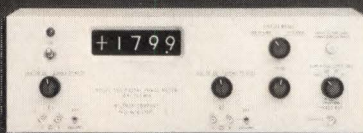

825 E. Middlefield Rd.
 Mountain View, CA 94043
 (415) 969-6500

Circle 252 on reader service card

Gas Sensing Semiconductor

FIGARO
 TGS
GAS
SENSOR

quickly senses
 even small
 amount
 of gas.



Applications

1. Natural Gas-Leak Alarm
2. Propane Gas-Leak Alarm
3. Carbon Monoxide Detector
4. Automatic Fan Control
5. Fire Alarm (Detecting combustible gases contained in smoke)
6. Alcohol Detector (Detector for drunken driver)
7. Air Pollution Monitor

Please contact any of the addresses below directly for catalogs and price/delivery information.

FIGARO ENGINEERING INC.

● Head Office: 3-7-3 Higashitoyonaka, Toyonaka City, Osaka, 560, JAPAN. TELEX: 05286155 FIGARO J. CABLE: FIGARO TOYONAKA. TEL: (06) 849-2156

● North America: 3303 Harbor Boulevard, Suite D-8, Costa Mesa, California 92626, U.S.A. TELEX: 678396 CABLE: FIGARENGIN COSTAMESA TEL: (714) 751-4103

Circle 253 on reader service card

New products

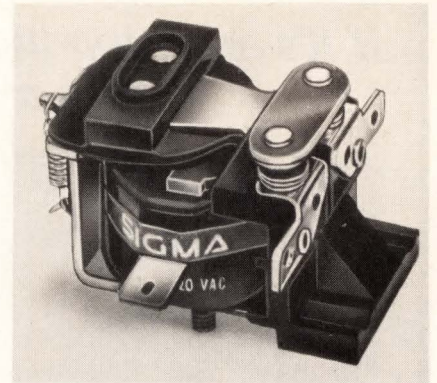

hp and 0.75 hp. The relays utilize molded nylon coils for dust and moisture resistance and enhanced heat dissipation. They have expected lifetimes of 200,000 operations at rated load. In hundreds, the double-make version sells for \$3.60 each, and the double-throw relay is priced at \$4.

Sigma Instruments Inc., 170 Pearl St., Braintree, Mass. 02184. Phone Robert E. Cullen at (617) 843-5000, Ext. 344 [377]

Power-line simulator
 has variable frequency

Designed to test protective relays and other frequency-sensitive devices, the model VFS-50 is a solid-state variable-frequency generator-amplifier. Its frequency can be varied over the range of 55 to 65 Hz (50 to 70 Hz is also available). The unit includes precision meters for monitoring voltage and frequency. Electrical Testing Instruments Ltd., 77 Progress Ave., Scarborough, Ontario, Canada M1P 2Y7 [374]

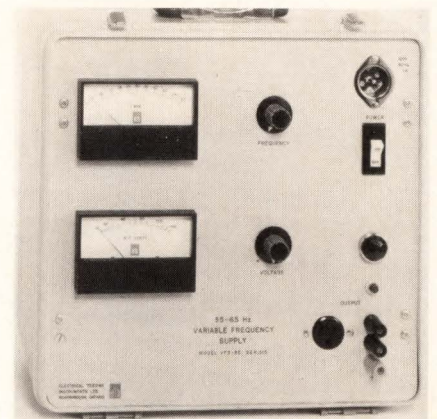

Circle 185 on reader service card →

We know your needs. Electronics Magazine Book Series. Zero-risk trial offer.

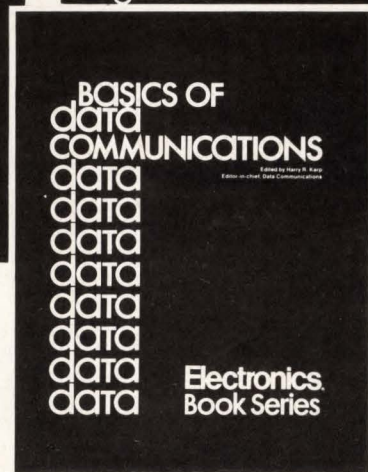
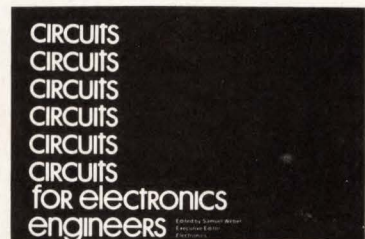
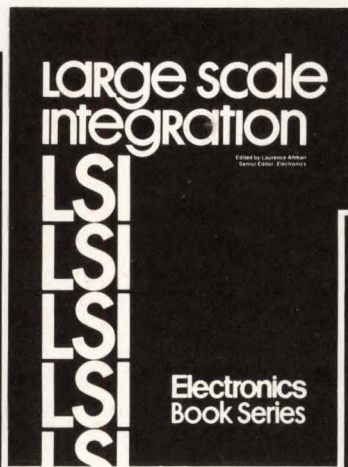
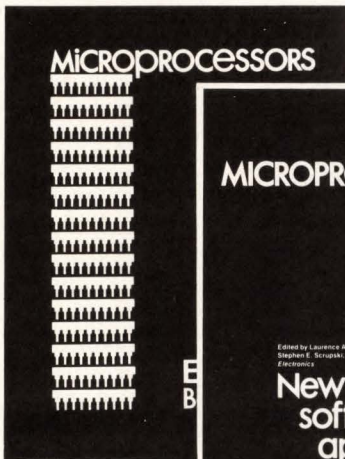

1. Microprocessors

What you must know about available microprocessor technology, devices, information, 4th printing. \$8.95

2. Applying Microprocessors

2nd and 3rd generation technology. 26 detailed applications from data networks to video games. \$9.95

3. Large Scale Integration

Covers the basic technology, new LSI devices, LSI testing procedures, plus system design and applications. \$9.95

4. Basics of Data Communications

Includes 47 articles from Data Communications magazine covering more than 11 key areas. \$12.95

5. Circuits for Electronics Engineers

Contains 306 circuits arranged by 51 functions from Amplifiers to Voltage Regulating Circuits. Saves design drudgery. \$15.95

Electronics Book Series

McGraw-Hill Publications Company, Shoppenhangers Rd., Maidenhead, Berkshire SL62QL, England.



1. Send me _____ copies of "Microprocessors" at \$8.95 per copy.
2. Send me _____ copies of "Applying Microprocessors" at \$9.95 per copy.
3. Send me _____ copies of "Large Scale Integration" at \$9.95 per copy.
4. Send me _____ copies of "Basics of Data Communications" at \$12.95 per copy.
5. Send me _____ copies of "Circuits for Electronics Engineers" at \$15.95 per copy.

Discounts of 40% on orders of 10 or more copies.

I must be fully satisfied or you will refund full payment if the book is returned after ten-day trial examination.

Payment enclosed Bill firm Bill me

Charge to my credit card:

- American Express Diners Club
 BankAmericard Master Charge

Acc't No. _____ Date exp. _____ Interbank No. _____

On Master Charge only,
first numbers above name _____

Name _____ Title _____

Company _____

Street _____

City _____ State _____ Zip _____

Signature _____

Thermotron's new Mini-Max Temperature-Humidity Chambers.

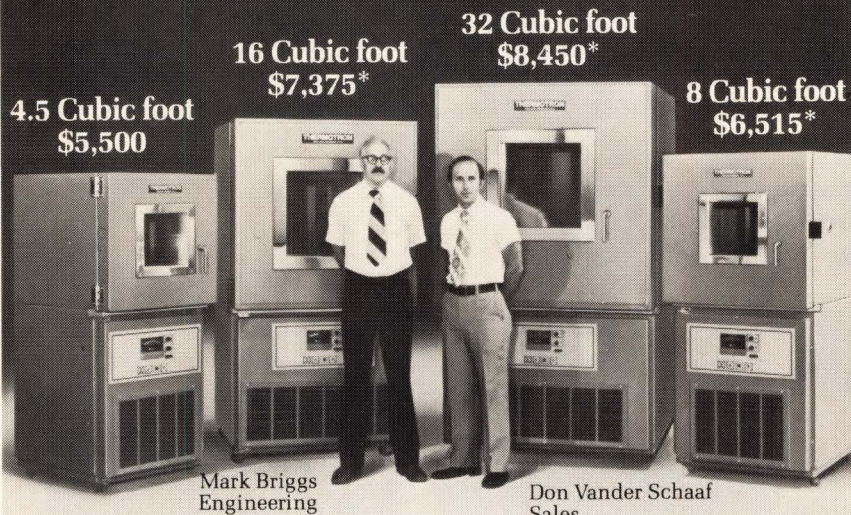

LOWEST COST

Thermotron's Mini-Max chambers are standard designs, manufactured in quantity. This standardization and volume means lower cost to you.

PROVEN RELIABILITY

These new Temperature/Humidity chambers are an addition to the established Mini-Max line, already tested and proven through years of rugged service here and abroad.

PRODUCT SUPPORT

Offices in principal cities, service technicians strategically located across the country and training schools are all part of every Thermotron product. You're supported when you buy and as long as you use Thermotron systems...that's a long time.

7 MODELS

Mini-Max Temperature/Humidity chambers are available in both **single stage** (-29°C to +93°C) and **cascade** (-68°C to +93°C) models with $\pm 1/2^\circ$ control. Humidity range: 20% to 98% with $\pm 2 1/2\%$ control. Single stage only on 4.5 cubic foot model, both single and cascade on other three models.

FEATURES YOU WANT

Thermotron's humidity instrumentation control system combines a precision mirrored-back panel meter with two multi-turn set point potentiometers to indicate dry bulb/wet bulb thermocouple and set point signals on a single analog scale. It eliminates calibration errors with a common meter to indicate both functions. Accuracy, $\pm 1\%$ of scale. Accessory list available on request.

*Cascade prices slightly higher

Systems to simulate any environment man or nature can create.



Small Business Subcontractor of the Year • 1977 / Region 5

THERMOTRON CORPORATION

KOLLEN PARK DRIVE, HOLLAND, MI 49423; PHONE 616-392-1492; TWX 810-292-6164

Circle 192 on reader service card

1977 Answer Book. It makes your job easier. \$25.

Who makes what? Over 4000 products, more than 5000 manufacturers with their local contracts and distributors, directory of trade names and catalogs, post-paid inquiry cards for 5-second ordering of current catalogs.

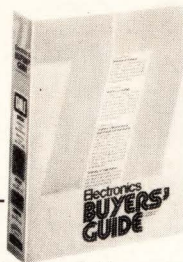

Electronics Buyers' Guide
1221 Ave. of the Americas
New York, N.Y. 10020

Yes, send me a copy of The Answer Book. I've enclosed \$25 (USA and Canada only, elsewhere send \$35). Full money back guarantee if returned within 10 days.

Name _____
Company _____
Street _____
City _____ State _____ Zip _____

New literature

Rfi shielding. A 20-page catalog describes cases, accessories, and gaskets that are shielded against radio frequency interference. The cases are grouped into blank, standard, and custom series along with photographs and diagrams, which illustrate each type. Information on circuit boards, rf connectors, test cables, adapters, coaxial terminations, and attenuators is included. Marketing Department, Compac, 279-I Skidmore Rd., Deer Park, N. Y. 11729. Circle reader service number 421.

Photodiodes. A 16-page product guide "Solid-State Silicon Photodiodes," OPT-112C, tabulates the data and gives outline configurations for a line of silicon photodetectors. Included are single-element and quadrant p-i-n diodes, avalanche photodiodes, and hybrid photodiode-preamplifier assemblies. The selection guides provided for each of these devices list key system requirements and electrical characteristics. RCA Corp., Box 3200, Somerville, N. J. 08876 [422]

Solid-state choppers. Information about solid-state choppers contained in a 32-page catalog is being offered by Solid State Electronics Corp., 15321 Rayen St., Sepulveda, Calif. 91343 [423]

Computers and processors. "Digital Signal Computers and Processors" is a compilation of papers dealing with the hardware aspects of digital signal processing. Emphasis is placed on the architecture and applications of high-speed computers and processors that implement digital signal algorithms. The 352-page volume can be obtained at \$12.95 for the IEEE members' paperbound edition; the hardcover edition costs \$25.95, discounted to \$19.45 for IEEE members. IEEE Service Center, 445 Hoes Lane, Piscataway, N. J. 08854. [424]

Timers. Technical information on program, percent, push-button, and interval timers, as well as delay relays, time meters and power heads,

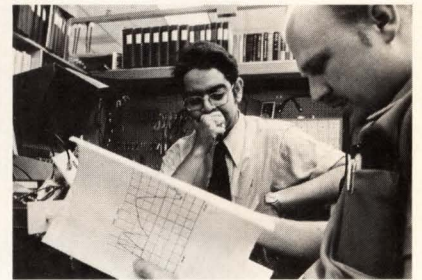
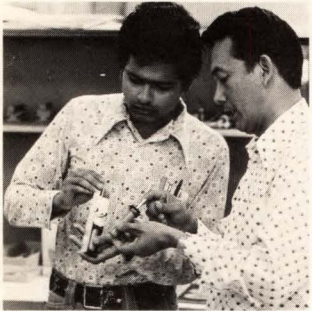
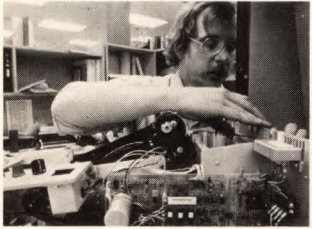
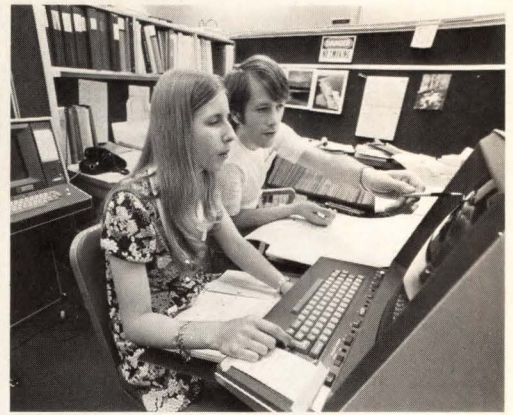

Here's technical achievement for you... better living for you and your family.

We're particularly anxious to meet you if you're a circuit-design, packaging and mechanical, or software engineer—or a specialist in electron optics, vacuum technology, or materials and processing. But whatever your technical strengths, if roll-up-the-sleeves engineering appeals to you, we'd like to hear from you.

At Tektronix you'll find an environment that emphasizes the individual, and his personal contribution to technical development—by working on projects, not writing about them. Your work will benefit advanced engineering throughout the world. Personal professional growth comes from working with first-rate

people who are experienced in developing state-of-the-art instrumentation, components, and devices.

All Tektronix R & D—financed entirely from our annual sales of approximately \$455 million—is directed toward commercial products. Our community is prosperous, with a stability of employment not typical of every industrial center.

Tektronix is located just outside of Portland, one of the nation's most liveable cities. We live in a green land. Mt. Hood and winter sports are a short drive to the east—the Pacific Ocean is just beyond the forested Coast Range to the west.

If you're seeking technical advancement and better living for you and your family, write to us.

**Tektronix Professional Placement,
Tektronix, Inc.**
P.O. Box 500E, Beaverton, Oregon 97077
Please send me an application form.

Name _____

Address _____

City _____

State _____ Zip _____

Tektronix®
COMMITTED TO EXCELLENCE

An equal opportunity employer.

**WE'LL SEND YOU A SAMPLE
TO PROVE OUR POINT.**

*Replaceable electrical
contacts for
reliable circuit
testing*

The sample will demonstrate how easily the probe tip is replaced without disturbing the wiring. We'll also send complete specifications illustrating the variety of standard sizes and tip styles available from stock. Let us prove our point. Contact

EVERETT/CHARLES INC.

2806 Metropolitan Place, Pomona, CA 91767
(714) 593-2541.

Circle 194 on reader service card

**Get a grip on
wire harness rejects
with Gudebrod's
new "Z" Finish tapes!**

The costliest of all harness room problems—rejects, often result from tie slipping and bunching caused by vibration. Improperly coated tapes and plastic ties just can't be trusted to stay put under vibration, but Gudebrod's Nomex and Dacron tapes with the new "Z" Finish provide the most secure grip possible to insure that a harness maintains its proper configuration and that tie slipping is virtually eliminated.

Talk to your Gudebrod rep about "Z" Finish tapes or write:



Gudebrod, Inc., Dept. T121
12 South 12th St., Phila., Pa. 19107
Phone (215) 922-1122 or (516) 825-4616

New literature

is given in a 13-page catalog. Definitions and schematics are provided for each of these devices. Precision Timer Co. Inc., Westbrook Industrial Park, Westbrook, Conn. 06498 [425]

Detectors. A six-page catalog of evaporated-multijunction thermopile detectors gives technical descriptions and cites possible applications for each type. The inclusion of base and side dimensions will aid an engineer to decide which detector is correct for his production requirements. Sensors Inc., 3908 Varsity Dr., Ann Arbor, Mich. [426]

Timesharing. A 10-page brochure called "Put a Macro in Your Micro" provides information on the Alpha Micro, which consists of a 16-bit microprocessor and a software operating system. The combined hardware and software system provides a low-cost timesharing package that can be tailored to the varied needs of the original-equipment manufac-

**PUT A
MACRO IN YOUR
MICRO!**



TIMESHARING 16-BIT MICROPROCESSOR
MULTI-USER S-100 BUS COMPATIBLE
MULTI-TASKING DISK OPERATING SYSTEM

turer, businessman, engineering personnel, and computer hobbyist groups. MicroAge, 803 N. Scottsdale Rd., Tempe, Ariz. 85281 [428]

Instrumentation amplifiers. Encapsulated-instrumentation amplifiers are detailed in a six-page brochure that even gets into the theory of operation for the model 176 and 178 amplifiers. The brochure discusses in

If you think logic analyzers, recorders or scopes are the only way to debug digital circuitry, you're wrong.

We'll You'd like to take the
show you. guesswork out of debugging
the complex circuitry you've
designed. Make it less of an art
and more of a science.

You'd like to have a known, stable signal to input to your circuit, so you can tell whether its output is on target. But the multiple pulse or wave generators, flip flops, logic gates or other gear you've been using to generate your word and timing patterns just aren't enough. You can't program them easily or with any guarantee they're accurate.

You'd rather have a single instrument that has multiple channels and is easily programmed. So you can input *exact* duplicates of the real programs your circuit will be handling. So you can tell at a glance whether your output is right.

But nobody makes a single unit like that, right? Wrong!

Interface Technology is going to show you.

We'll show you a self-contained, low-cost, small digital debugging tool for \$2,500 and up. A multi-channel, microprocessor-controlled data and timing generator that's programmable with only 16 instructions. A general purpose tester that can generate large amounts of digital data, that's interactive, can respond to external stimuli and make decisions. A benchtop instrument that can be used rack-mounted as part of a computer-driven system, or as the core of a low-cost, stand-alone digital test system.

We'll show you how our multi-channel programmable digital systems can lower your design time. We'll show you how you can be *sure* about your final product. And we'll show you how we're already working for people like General Dynamics, Rockwell and Hughes and how we can work for designers like you.

We'll put the whole show on the road and demonstrate our digital test systems for you in person. And all you have to do is call collect: (213) 966-1718. Or write to the address below.

interface
TECHNOLOGY

852 North Cummings Road • Covina, California 91724 • (213) 966-1718

\$74.95 **JL SOURCE.**

It's CSC's DP-1: the automatic signal source that cuts hours from trouble-shooting TTL/DTL, CMOS and other popular logic circuits.

This compact, circuit-powered unit lets you inject signals at key points to test digital circuits with fast stimulus-response troubleshooting techniques. Just set a switch to the proper logic family; connect two clip-leads to the circuit's supply, and touch the DP-1 probe to a node. It automatically senses the circuit's condition (high or low state) and produces an opposite-polarity pulse of the proper level. That's all there is to it!

Versatility-flexibility. Select single-pulse or 100 pulse-per-second operation with the handy pushbutton control. A LED indicator signals single-shot or continuous mode. DP-1 can also be connected indefinitely, presenting a 300K impedance to the circuit under test. Short circuits can't harm it, even over prolonged periods. It's also protected against overvoltage up to 25V and reverse-polarity up to 50V.

For all its versatility, portability, operating ease and compact size, DP-1 is priced at only \$74.95—a fraction of what you'd expect to pay for a precision digital pulse source. See your CSC dealer today. Or call 203-624-3103 (East Coast) or 415-421-8872 (West Coast) for the name of your local stocking distributor and a full-line catalog.

Logic family switch—Sets proper pulse level for TTL/DTL or CMOS families.

Rugged, high-impact plastic case—Built to take it... in the lab or in the field.

Protected—Features built-in short-circuit, overvoltage and reverse-polarity protection.

Operating mode pushbutton—Selects single-shot or 100 pps operation.

LED Pulse indicator—Monitors operating mode.

Interchangeable ground leads connection—provide ground-side input connection, where desired, via optional cables.

Interchangeable probe tips—For greater versatility. Straight tip supplied; optional alligator clip and insulated quick-connecting clip available.

Plug-in leads—24" supplied, with non-corrosive nickel-silver alligator clips.

SPECIFICATIONS

Tri-state-output—DP-1 is isolated from circuit under test: $Z \geq 300K$

Auto-polarity pulse sensing—DP-1 automatically produces proper polarity pulse for circuit under test: logic "0" level produces a "1" pulse; logic "1" level produces a "0" pulse

LED indicator—flashes once for single pulse; stays lit to indicate pulse train

Short-circuit protection—can pulse into short circuit continuously

Power—overvoltage protected to 25V, reverse-voltage protected to 50V; voltage range 4-18V, 30mA max.

Pulse modes—Single pulse; press pushbutton for one sec. or less. Pulse train (100pps): hold pushbutton down

Pulse specs	TTL	CMOS
Pulse width	1.5usec \pm 30%	10usec \pm 30%
Fan out	60 loads	
Sink and Source	100mA source to 3.5V; sink to .6V	50mA source to logic 1; sink to logic 0
T_r	100nsec	100nsec
T_f	one TTL load, 500nsec	100K load, 8nsec

* T_r is directly proportional to load resistance

Dimensions (l x w x d) 5.8 x 1.0 x 0.7" (147 x 25.4 x 17.8mm)

Weight 3 oz. (.085kg)

Power Leads plug-in 24" (610mm); color coded insulated clips; others available

ACTION	MOMENTARY PRESS OF PUSH-BUTTON	RELEASE PUSH-BUTTON	CONTINUOUS PRESS OF PUSH-BUTTON (OVER 1 SEC.)
LED	FLASHES	OFF	ON
OUTPUT	DP-1 SENSES LOGIC "1" (HIGH), PRODUCES "0" PULSE OR 100 PPS PULSE TRAIN LOGIC 1: [Pulse] [Train] LOGIC 0: [Pulse] [Train]		
OUTPUT	DP-1 SENSES LOGIC "0" (LOW), PRODUCES "1" PULSE OR 100 PPS PULSE TRAIN LOGIC 1: [Pulse] [Train] LOGIC 0: [Pulse] [Train]		

NOTE. SEE SPECIFICATIONS FOR DUTY CYCLE

CONTINENTAL SPECIALTIES CORPORATION



44 Kendall Street, Box 1942, New Haven, CT 06509
 203-624-3103 TWX 710-465-1227
 West Coast: 351 California St., San Francisco, CA 94104
 415-421-8872 TWX 910-372-7992
 Great Britain: CSC UK LTD.
 Spur Road, North Feltham Trading Estate,
 Feltham, Middlesex, England.
 01-890-8782 Int'l Telex: 851-881-3669

Circle 196 on reader service card



*Manufacturer's Recommended Resale

©1977 Continental Specialties Corporation

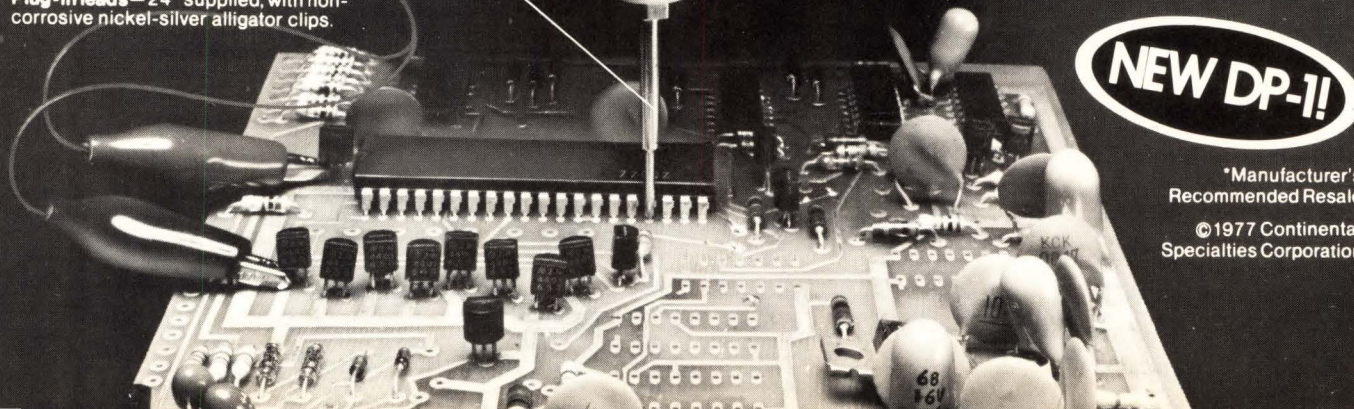
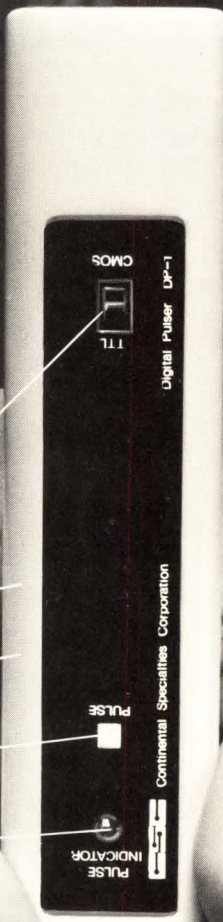

SALES OUTLETS WANTED NEW 30 AWG STRIP AND WRAP TOOL

A new tool that automatically strips the correct length of wire and makes a modified wrap is available for distribution.

These are its advantages:

- ★ does not use hard to store and handle prestripped wire,— works direct from the reel
- ★ is of simple reliable patented design
- ★ is easy to use and reasonably priced
- ★ comes in hand and gun versions
- ★ is ideal for prototyping and small quantity production

Further details from:

BO-6079, Electronics
Class. Adv. Dept.,
P.O. Box 900, NY, NY
10020

Circle 226 on reader service card

The 1977 Answer Book. It makes your job easier. \$25.

- Over 4000 products.
- More than 5000 manufacturers with local sales offices, reps/and distributors.
- Directory of Catalogs with postpaid inquiry cards for 5-second ordering of current catalogs.

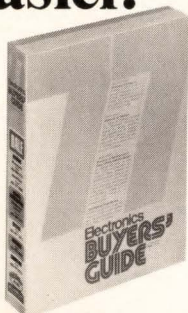

Electronics Buyers' Guide
1221 Ave. of the Americas
New York, N.Y. 10020

Yes, send me a copy of The Answer Book. I've enclosed \$25 (USA and Canada only, elsewhere send \$35). Full money back guarantee if returned within 10 days.

Name _____
Company _____
Street _____
City _____ State _____ Zip _____

New literature



depth the characteristics of common-mode rejection and frequency response for these models. Also described are the differences between them, to ease selection of the correct unit for a particular application. Calex Manufacturing Co., 3355 Vincent Rd., Pleasant Hill, Calif. 94523 [429]

Packages. Twenty-seven product sheets describe flat packs and dual in-line packages. Drawings include specifications for flat packs in standard and deep versions with leads on 30- and 50-mil centers and on 14 and 16 DIPS. Packaging dimensions, base material, matching lid number, and package part number are provided with each drawing. Mini-Systems Inc., 20 David Rd., North Attleboro, Mass. 02761 [430]

Component data. A summary of component testing and screening data is contained in a quarterly report for April, May, and June 1977. The statistical information is given for diodes, hybrids, transistors, triacs, and integrated circuits. Continental Testing Laboratories, 763 U.S. Highway 17-92, Fern Park, Fla. 32730 [431]

Systems engineering. A series of papers on systems engineering has been compiled into a 408-page booklet. The papers focus on applications in the fields of energy, resource and land use, and medicine and health. Each of these items is preceded by an explanation of the subject matter. The volume can be obtained at \$14.95 for the IEEE members' paper-bound edition; the hardcover edition costs \$29.95, discounted to \$22.45 for IEEE members. IEEE Service Center, 445 Hoes Lane, Piscataway, N. J. 08854 [432]

We'll show you:

PACIFIC COAST

Ward/Davis Associates
Lawndale, CA 213-542-7740
La Jolla, CA 714-459-3351
Sunnyvale, CA 408-245-3700

MID-ATLANTIC

Eastern Instrumentation of
New York
Englewood, NJ 201-567-9505
Eastern Instrumentation of
Philadelphia
Philadelphia, PA 215-927-7777
Naco Electronics
Syracuse, NY 315-699-2651
Utica, NY 315-732-1801
Fairport, NY 716-223-4490
Creative Marketing Associates
McLean, VA 703-893-6612

ROCKIES/SOUTHWEST

BFA Corporation of Arizona
Scottsdale, AZ 602-994-5400
Denver, CO 303-837-1247
Albuquerque, NM 505-292-1212
Las Cruces, NM 505-523-0601
Salt Lake City, UT 801-466-6522

NEW ENGLAND

Instrument Dynamics
Wakefield, MA 617-245-5100

SOUTH CENTRAL

Data Marketing Associates
Houston, TX 713-780-2511
Dallas, TX 214-661-0300
San Antonio, TX 512-828-0937
Austin, TX 512-451-5174
Norman, OK 405-364-8320

MIDWEST

Carter Electronics, Inc.
Minneapolis, MN 612-559-1976
Chicago, IL 312-585-5485
Indianapolis, IN 317-293-0696
Milwaukee, WI 414-464-5555
St. Louis, MO 314-569-1406
Overland Park, KS 913-649-6996

interface

TECHNOLOGY

Circle 197 on reader service card

Salon international des Composants Electroniques

3-8 avril 78 - Paris

All electronic components + measuring instruments, material and products + equipment and methods specific to the manufacture and installation of electronic components.



Further particulars and free entrance cards on request: S.D.S.A. 20 rue Hamelin F 75116 Paris
Tél.: (33-1) 505.13.17 - Tx 630.400 F.

Don't miss it, others won't.

Circle 262 on reader service card

7 Major Routes to Reliability, Provided by the RAC

- System Reliability and Maintainability Consulting Services
- Customized Data Searches
- Semiconductor Device Reliability Databooks
 - Digital Data
 - Linear/Interface Data
 - Memory/LSI Data
 - Hybrid Circuit Data
 - Transistor/Diode Data
- Reliable Equipment Design Guidelines
 - Design Reliability Handbook
 - Microcircuit Reliability Bibliography
- Tutorial Reliability Courses
- Annual Reliability Workshop
- Periodic Reliability Seminars

RAC



Reliability Analysis Center
RADC/RBRAC, Griffiss AFB, NY 13441

Phone 315-330-4151, Autovon 587-4151

RAC is a DoD Information Analysis Center Operated by IIT Research Institute

SUPER MINIATURE

Neon Glow Lamps

Circuit Volts..... AC 105-125
Series Resistance..... 150KΩ
Nominal Current..... 0.3mA
Total Flux..... 20mlm MIN.
Average Life Hours... 30,000

Dimension: mm

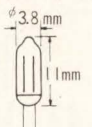

NL-8S

CLEAR-GREEN

Fluorescent Glow Lamps

Circuit Volts..... AC cr DC 105-125
Series Resistance..... 33KΩ
Nominal Current..... 1.6mA
Total Flux (MIN.)..... AC: 120mlm, DC: 130mlm
Avg. Life Hours..... AC: 30,000 DC: 40,000

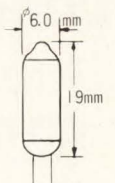

NL-35/G

Circuit Volts..... AC 105-125
Series Resistance..... 27KΩ
Nominal Current..... 1.5mA
Total Flux..... 90mlm MIN.
Avg. Life Hours..... 20,000

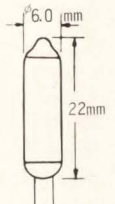

NL-21/G

● MAIN PRODUCT

NEON GLOW LAMP, XENON FLASH LAMP,
RARE GAS, DISCHARGE LAMP.
MINIATURE : BLACK-LIGHT, UV-LIGHT,
FLUORESCENT COLOR-LIGHT.

ELEVAM ELECTRONIC TUBE CO., LTD.

NO. 17-8 CHUO 2-CHOME OTA-KU, TOKYO JAPAN
TELEPHONE : 03 (774) 1231~5

EXPORT DIVISION : JAPAN NANOTRONIX CO., LTD.
OTA-KU TOKYO, TELEPHONE. (03)775-4811 TELEX 246-6583 JNANOX

If you're this kind of systems OEM,

You're building complex turnkey projects.

You need more than "iron".

You know that your best buy is not a mixed bag of bottom-priced components, but a proved system, with all essential support, from a supplier who becomes your working partner.

we're your kind of computer systems source.

We're different. Instead of selling you black boxes, we supply complete computer systems. We've been doing this for seven years.

We have a state-of-the-art line of standard processors, memories, I/O devices, terminals and other peripherals. Plus proved system operating software that speeds

Two Modcomp IV and four Modcomp II processors are the center of a new digital traffic control system for the city of Baltimore, engineered by TRW Inc. The TRW system has the capacity to control signals at 1200 key intersections in the city, and also provide surveillance of a five-mile section of the Jones Falls Expressway.

your application programming. Advanced network and transaction software. And we'll quote special hardware and software where needed.

You'll like our systems engineering help, because we understand system problems. And we don't love you and leave you, but supply full support — field service, documentation, personnel training, even sales support.

What you get from MODCOMP is a fully checked-out system, factory burned-in, ready to bring on-line quickly and efficiently.

Get the full MODCOMP OEM story, by asking for the brochure, "Power Tools For Building OEM Systems". Modular Computer Systems Inc., 1650 W. McNab Road, Fort Lauderdale, Fla. 33309. (305) 974-1380.

MODCOMP

The systems store.

European Headquarters:

Export House, Woking,
Surrey, England
Phone: (04862) 71471

Circle 199 on reader service card



What the heck is a surge arrester?

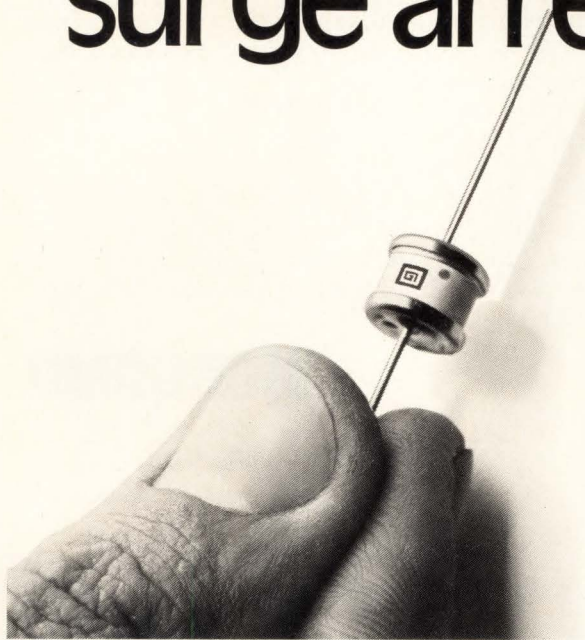

This tiny device protects equipment from induced overvoltages due to atmospheric disturbances or accidental contact with power lines. It's generally connected from a signal line to ground.

How does it work? The surge arrester has a high impedance when the voltage across it is less than its striking voltage. (Striking voltages range from 75 volts to 1000 volts depending upon the application.) When the striking voltage is exceeded, the surge arrester changes impedance from greater than 10,000 megohms to mere milliohms in about 1 microsecond. The overvoltage is discharged to ground through the surge arrester which then returns to its original high impedance state. And your equipment is protected.

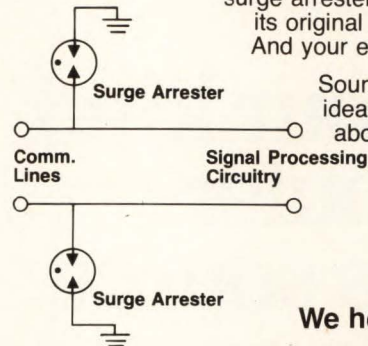

Sound simple? All the best ideas do. To find out more about our surge arresters just write.

We help you compete.

**C. P. CLARE & COMPANY
GENERAL INSTRUMENT CORPORATION**



3101 W. Pratt Avenue, Chicago, Illinois 60645

Circle 200 on reader service card

MDB SYSTEMS presents... The NOVA* Connection

GP Interface Modules · Peripheral Controllers · Communications Interfaces · Accessory Hardware

New: Four or Eight Channel Multiplexors · Multiple I/O Controller

MDB Systems products always equal and usually exceed the host manufacturer's specifications and performance for a similar interface. MDB interfaces are software and diagnostic transparent to the host computer. MDB products are competitively priced; delivery is usually within 14 days ARO or sooner.

Here are some MDB Systems connections to Data General NOVA computers:

- General Purpose Interfaces: GPIO similar to Nova 4040, with PC'd interface logic and wire wrap section for 105 wire wrap devices. Full wire wrap board for 215

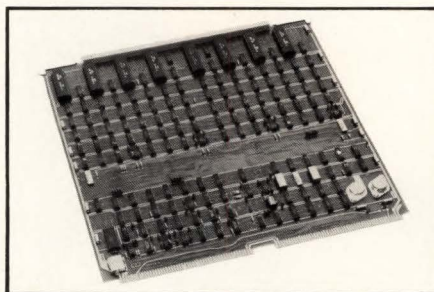

- sockets or DIP devices.
- Device Controllers for most major manufacturer's Printers Card equipment Paper Tape equipment
- Four or eight channel Multiplexors, Nova 4060 compatible, with many additional program controlled features. Full modem control contained on board. Optional panel for multiplexor provides standard 25 pin communications connectors for each channel.

- Multiple I/O board for TTY and/or RS-232 Controllers. Options include Real Time Clock and modem control.
- Accessory Hardware Front loading expansion chassis, optional power supply configurations, chassis may be terminated or daisy chained. Terminator modules. Extender boards. Check first with MDB Systems for your NOVA computer interface requirements.

MDB also supplies interface modules for DEC PDP-11* and Interdata computers and for DEC's LSI-11 microprocessor.

MDB
MDB SYSTEMS, INC.

1995 N. Batavia St., Orange, California 92665
714/998-6900 TWX: 910-593-1339

*TMs Data General Corp. & Digital Equipment Corp.

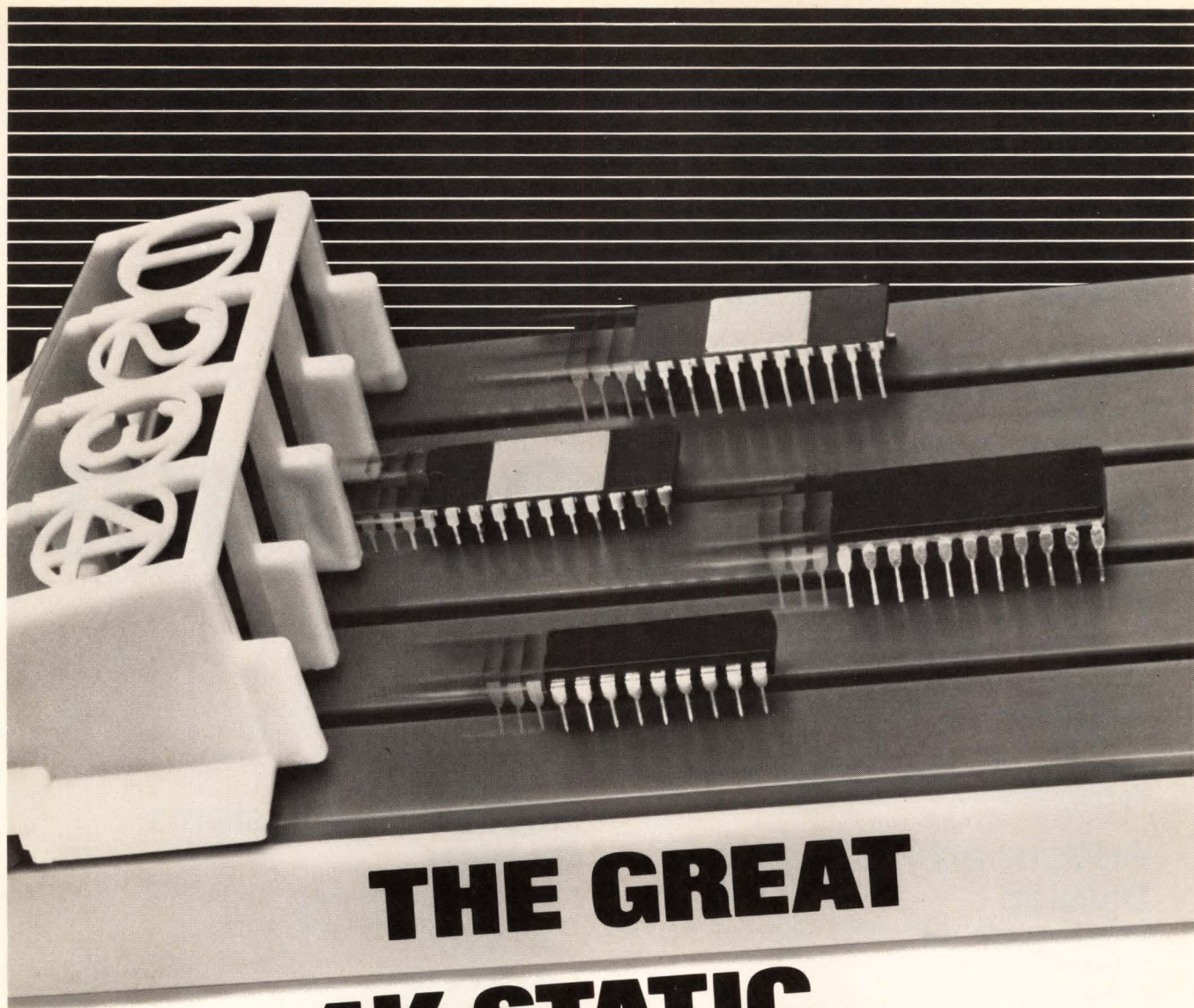

THE GREAT 4K STATIC RAM RACE

In a world of claims and counter-claims, one thing is clear. EMM SEMI is still in the lead. Of course, we not only had a healthy head start, but we field a whole family of 4K static RAMs.

We *delivered* the industry's first 4K static RAM in 1975, a full year and a half before anyone else. We are now delivering 7 basic static RAM types with many versions

of each, and producing them at a greater monthly rate than our nearest competitors combined.

By now we have more 4K static RAMs operating in a wider range of customer equipment than anyone else in the semiconductor memory business — from 10 Megabyte IBM add-on memory systems to hobbyist microprocessor kits.

Whatever your application, from mass storage to telecommunications, from medical electronics to toys and games, chances are there's an EMM SEMI static RAM just right for you. Please call or write today for full details — and ask about our byte oriented RAMs, too.

Memory at work **EMM SEMI, Inc.**

Technological Leadership for 3 Decades!

Ampex, headquartered on the San Francisco Peninsula, is the company that "invented" the magnetic recording industry.

The technology pioneered by Ampex over three decades has affected many aspects of our modern lifestyles, and has established Ampex as a leader in magnetic recording. Our continued effort in developing new technology has always been the key to our leadership. Right now our Advanced Technology, Data Products and Audio-Video Systems Divisions are embarking on several new programs. To insure the success of these programs we are seeking innovative graduate engineers with experience in the fields listed below.

Opportunities like this don't happen very often. But they're happening at Ampex now.

Advanced Technology Division

- electron beam and optical recording
- magnetic recording
- tape or film handling
- servos
- high-bit rate digital circuit design
- optics
- signal analysis
- pattern recognition
- high frequency circuit
- communications theory

Data Products Division

- circuit/systems design of very high-bit rate systems

- disk read/write systems and equalizing systems for tape recorders
- codes for magnetic recording
- precision servo systems for both linear positioners and rotating systems
- mechanical design of high precision systems in disk recorders and in longitudinal, helical and transverse scan tape recorders

Audio-Video Systems Division

- analog videotape signal systems
- digital video signal processing
- servo systems
- videotape editing
- professional audio recorders
- head technology
- TV cameras

If you think you have something valuable to offer in any of these or closely related areas, and if you would like to join some of America's most talented engineers, please send your resume or a letter outlining your qualifications to: Ampex Corporation, ATTN: J.C. Puckett, Building 2, 2655 Bay Road, Redwood City, CA 94063. Or you can send us this coupon and we'll get back to you. We are an equal opportunity employer m/f.

Manager Corporate Staffing
AMPEX Corporation
Building 2, 2655 Bay Road
Redwood City, CA 94063
 Dept. 4

Occupation _____
 Years of Experience _____
 Employer _____

Name _____
 Address _____
 City, State, Zip _____
 Phone _____



Classified section FOR ENGINEERING/TECHNICAL EMPLOYMENT OPPORTUNITIES

CLASSIFIED SALES REPRESENTATIVES

Atlanta... Jane Core ... 404/892-2868
 Boston ... Holt Buchanan ... 617/262-1160
 Chicago ... Bill Higgins ... 312/751-3733

Cleveland ... Mac Huestis ... 216/781-7000
 Dallas ... Mike Taylor ... 214/742-1747
 Denver ... Shirley Klotz ... 303/837-1010
 Detroit ... Mac Huestis ... 313/873-7410

Houston ... Mike Taylor ... 713/659-8381
 Los Angeles ... Stan Kassir ... 213/487-1160
 New York ... Larry Kelly ... 212/997-3594
 Philadelphia ... Dan Ferro ... 215/568-6161

Pittsburgh ... Dean Genge ... 412/391-1314
 San Francisco ... M.E. Kenny ... 415/362-4600
 Stamford ... Holt Buchanan ... 203/359-2860
 XEROX 400 TELECOPIER ... 212/997-6800

VIDEO TAPE ENGINEERS

JOIN OUR ELITE DEVELOPMENT TEAM

Design State-of-the-Art rotary head video instrumentation tape recorders for BMZ frequency response & 3ns residual time base error.

Bell and Howell, already a world leader in instrumentation magnetic recorders, is now deeply into video. Unusual ground-floor opportunities exist for:

■ PRINCIPAL ENGINEER

Design & Test

Design signal systems and subsystems such as VTR FM modulators, demodulators, equalizers, preamps, record amps and electronic time base correctors. Work on small signal, high linear circuit design. Prefer BSEE (or equivalent) plus indepth experience in design and test of video instrumentation electronic circuits. High Speed A-D conversion experience desirable.

■ SENIOR DESIGN ENGINEER

Design capstan, scanner and other servos for rotary-head Video Instrumentation Recorder/Reproducer. Prefer BSEE (or equivalent) plus extensive experience in VTR field demonstrating proven ability. Experience in VTR design and testing a real asset.

Besides the exceptional challenge, we offer a most comprehensive benefits program, liberal relocation and excellent salary. Candidates must be able to obtain DOD secret clearance. Please send your resume, including salary history, in confidence, to Helen Duner, Employment Coordinator, BELL & HOWELL, 360 Sierra Madre Villa, Pasadena, CA 91109. (213) 796-9381.



BELL & HOWELL

DATATAPE DIVISION

*We are an equal opportunity
/Affirmative Action Employer*

ELECTRONIC ENGINEERS

KEY POSITIONS

Our Municipal & Utility Division is searching for talented Electronic Systems and Field Test Engineers to live and work in beautiful Dallas, Texas.

In this division, we develop a broad line of flow measurement and energy related equipment. Last year our corporation spent \$85 million in R&D programs with many projects directed toward the solutions to key national challenges in the field of energy. As a result of these programs we are now beginning a new venture in Load Management/Carrier Current Communication Systems.

ELECTRONIC SYSTEMS ENGINEER

We prefer an advanced EE degree with several years experience in computer applications. Knowledge of switching and real time systems is preferred.

FIELD TEST ENGINEER

Must have a BSEE and several years proven experience in the installation and start up of electronic systems.

If you are interested in these exceptional career growth opportunities, please send resume including salary requirements, in complete confidence to:

Robert Arrington, Director of Engineering

ROCKWELL INTERNATIONAL
 MUNICIPAL & UTILITY DIVISION/PLCS
 P.O. Box 10462, Dallas, Tex. 75207



Rockwell International

Equal Opportunity Employer M/F



PRODUCT MANAGER PRECISION RESISTOR NETWORKS

ELECTRO FILMS is growing geometrically and is in process of expanding its physical plant. To continue this dynamic growth rate in a balanced way we require the services of a design/applications oriented person to oversee and direct progress in our precision packaged and unpackaged network activity.

Opportunity offers a capable and energetic individual financial growth and benefits tied directly to contribution.

Electro Films Incorporated
 100 MEADOW STREET - WARWICK, R.I. 02886 TEL. (401) 738-8150
 Micro Electronic Components and Services

We have been placing graduate ENGINEERS



in FEE-PAID positions THROUGHOUT THE U.S. since '59. Over 1,000 client companies. We are graduate engineers working full-time for you. Send resume & salary history today or request confidential application.

ATOMIC PERSONNEL, INC.
 Suite L. 1518 Walnut St., Phila., Pa. 19102
 An Employment Agency
 For All Technical Fields

TRANSFORMER ENGINEER

Audio and power design. 4 yrs. min. exp. Salary open. Reply to:

MICROTRAN
 P.O. Box 236, Valley Stream, N.Y. 11582.
 Phone 516-561-6050

PROJECT ENGINEER

Challenging Career Opportunities

Battelle, one of the world's leading not-for-profit research development and educational organizations, has immediate and rewarding opportunities for you in the following areas:

- Communications
- Circuit design
- Automatic control design
- Micro processor and minicomputer system control
- Electronic inspection
- Engineering and systems development
- Computer-aided manufacturing

These positions offer you challenging technical assignments in both research and marketing and participation with high-level industrial and government management. Positions require advanced degrees in Electrical Engineering, 3 to 17 years of industry experience (depending on position), and demonstrated leadership skills. We offer excellent starting income commensurate with your experience and the status of the position, a comprehensive benefits program and many unique opportunities for professional and personal recognition and advancement.

For immediate and confidential attention, send resume to:
L. G. Hill, Manager, Employment



Battelle

Columbus Laboratories
505 King Avenue
Columbus, Ohio 43201

An Equal Opportunity Employer

ENGINEERS

Are You Tired of a No Challenge Job?

We seek top caliber professionals to advance the state-of-the-Art in hybrid and discrete data conversion products.

SENIOR ELECTRONICS ENGINEER

Assume project responsibility and provide technical leadership to supporting staff members. Develop state-of-the-Art hybrid and discrete data conversion products. BSEE and minimum 5 years' analog circuit design experience required.

CIRCUIT DESIGN ENGINEER

Analyze, design and evaluate new analog and data conversion products under the guidance of senior electronics engineers. BSEE and 2-5 years' related experience required.

COMPONENTS ENGINEER

Responsible for evaluation of hybrid and discrete electronic components. Generation of electrical specifications for a wide variety of electronic components. BSEE and 2-5 years' related experience required.

HYBRID PACKAGING ENGINEER

Responsible for the design and layout of hybrid integrated circuits. Must be familiar with hybrid assembly and processing techniques. BSEE, BSME or equivalent work experience required.

SENIOR DESIGNER

Layout and documentation of hybrid and printed circuit electronic products. Must be a self-starter and have ability to work with minimum of supervision. Extensive related work experience required.

Teledyne Philbrick offers excellent salary and fringe benefits. If you qualify for one of the above positions, please submit your resume and salary requirements, in confidence to Robert A. Porter, Personnel Manager.

Allied Drive, Dedham, MA 02026

Teledyne Philbrick is an Affirmative Action and Equal Opportunity Employer

 **TELEDYNE PHILBRICK**

Broadcast Products Division

ENGINEERING SECTION MANAGER

This is an opportunity to join Harris, a diversified, strongly growing electronics and communications company, noted for successful planning and management. Our Division is an expanding leader, active worldwide, in radio and television broadcast and related equipment.

A key technical management position in a major product line is currently available. This position represents an immediate career opportunity for personal growth and management development in a progressive division of Harris Corporation.

Position responsibilities include the direction of all activities related to commercial broadcast transmitter design. Support of existing products, new product conception and development, as well as direct supervision of design engineers is required.

Qualifications for this opportunity include BS/MSEE and a history of personal growth as exhibited by increasing levels of responsibility including design engineering, project engineering, and supervisory experience. Experience in the R. F. product area helpful but not essential.

We offer favorable career prospects in a growth environment, competitive salaries and excellent benefits, and relocation assistance to our desirable small, progressive city. Please direct resume in confidence, giving full pertinent details including salary progression, in confidence to: Mr. Lawrence E. Carlstone, Professional Employment Supervisor, Harris Corporation, Broadcast Products Division, Quincy, Illinois 62301.



HARRIS
COMMUNICATIONS AND
INFORMATION HANDLING

An Equal Opportunity Employer—Male and Female

SEMTECH CORPORATION

Expanding manufacturer of quality power rectifiers offers excellent opportunity for:

MOS PROCESS ENGINEER PHOTORESIST

Participates in bringing into production a new generation of field effect power transistors.

Requires BS in Electronics or Physics plus a minimum of 3 years' experience in MOS wafer fabrication.

Salary commensurate with experience and ability. Excellent benefits including profit sharing.

Send resume with complete salary history to:

SEMTECH CORPORATION
652 Mitchell Road
Newbury Park, Calif. 91320

Equal Opportunity Employer M/F

TECHNICAL TRANSLATIONS

English/French by professional translator with over 10 years experience in electronic and electrical systems. Call or write:

JEAN LOUIS AVRIL
5ter, rue des Bois
92310 SEVRES FRANCE
Tel: (1) 027.68.99

ENGINEER—VACUUM TUBE

Small Co. need manager for high-powered vacuum tube rebuilding and manufacturing operation. Must be a take charge individual that enjoys a shirt sleeve atmosphere. A thorough knowledge of processing & test equipment required for both glass & ceramic vacuum tubes. A microwave background is valuable. Applications held in confidence. Send resume to:

J.M. COMPANY
1030 W. Maude, Suite 504
Sunnyvale, Ca. 94086

We're Looking for Innovators who are Seeking New Horizons in Telecommunications!

SOFTWARE
DESIGN &
DEVELOPMENT

Because those horizons have an infinite number of opportunities for technical accomplishment. We are doing research and development for the communications systems of the future.

CALL TOLL FREE (800) 323-1966

In Illinois (800) 942-0491 • Monday thru Friday from 8 am to 5 pm cst

There probably has never been such a massive new market for computer-controlled systems, GTE Automatic Electric supplies systems for both domestic and foreign customers, and telecommunications is one of the industries that is both basic and vital to every nation in the world. Let us tell you more about the vast growth potential, and of our unique position in the market.

SOFTWARE DESIGN ENGINEER

Responsible for the specification, design and testing of telephone systems support software, network and control software, or maintenance and diagnostics software. Prefer a minimum of 3 years' experience in structured design, coding, testing and documentation of programs; development with large data base on multi-file computers and real-time systems. HIPO design documentation, TSO usage and software simulation techniques. Requires a BS or MS in Computer Science or Electrical Engineering and specialized study in the use of PL/1, Fortran, Assembler, Intel 8080 and PDP-11 programming languages.

DATA BASE DESIGN

This position requires a minimum of 5 years' experience in the planning development, design and implementation of data base software, including data base management systems administration. Your primary responsibilities will be the development of data base system for a large on-going project including the implementation, support and administration of systems.

TELETRAFFIC & PLANNING ENGINEER

Responsible for the analysis of teletraffic probability and queuing problems on digital and analog switching systems and the development of computer programs for switching systems. Perform control and route reliability studies, define and analyze problems for future systems features and their applications. Prefer a minimum of 3 years' experience in real-time control systems teletraffic problems, systems equipment quantities specification, and exposure to switching system specifications. Requires a BS or MS in Electrical Engineering, Computer Science or Math and a strong statistical background and experience in PL/1 or Fortran programming and model simulation.

MINI-COMPUTER PROGRAMMERS

We have specific assignments available on project development teams responsible for the design implementation of various telecommunication processing systems utilizing mini-computers as the processing element. Responsibilities will include the development of software programs for real-time operating systems as well as unique hardware elements incorporated into the systems.

If unable to call, send resume including recent salary history to:

Manager of Technical Employment, Dept. 471 A6

GTE **AUTOMATIC ELECTRIC
LABORATORIES**

400 N. Wolf Road • Northlake, IL 60164

An Equal Opportunity Employer M/F

LSI

SENIOR LSI DESIGN ENGINEERS
CAD SYSTEMS ANALYSTS & PROGRAMMERS
CIRCUIT DESIGNERS
APPLICATIONS ENGINEERS
TEST ENGINEERS

Build your future in Connecticut at the ITT LSI Systems Support Center



Newly relocated to Connecticut, the ITT LSI Systems Support Center is planning on further expansion . . . and your career can grow right along with it. Corporate funded, our specialized technology center is charged with providing the means for optimum use of LSI in wide ranging ITT telecommunications, space, defense, automotive and commercial product areas. The increasing demand for LSI technology within the ITT system dictates our continued need to add to our highly qualified professional staff.

Positions are now available with unusual reach into the future, offering excellent "ground floor" opportunities for professional development and career advancement for those who qualify.

SENIOR LSI DESIGN ENGINEERS

Responsible for custom LSI design using state-of-the-art MOS and bipolar techniques. Activities include feasibility studies, chip design, characterization and qualification studies. Requires MSEE and 4 years experience using sophisticated computer-aided design layout and analysis techniques.

CAD SYSTEMS ANALYSTS & PROGRAMMERS

Responsible for the development and maintenance of software systems for various CAD applications including automatic placement and routing of circuits, checking art work, logic simulation program, and transient analysis for custom LSI chips. Requires BS in Engineering, Mathematics or Computer Science and minimum of 3 years CAD experience.

CIRCUIT DESIGNERS

Experienced designer in advanced LSI technologies. Responsible for design of complex LSI circuits in latest bipolar and MOS technologies. Requires BSEE and 2 years design experience using sophisticated computer-aided techniques.

LSI APPLICATIONS ENGINEERS

Direct interface with equipment division engineering personnel to identify and promote LSI design and application opportunity. Capable of assessing, analyzing, and coordinating the long range systems concept combining long range technology forecasting. Experience in telecommunications equipment highly desirable.

SENIOR TEST ENGINEERS

Interface with ITT equipment and systems divisions in testing philosophy and testability for new applications. Generate and debug test and characterization programs for custom and standard LSI circuits. Requires BSEE and 4 years in product and test engineering. Sentry experience and knowledge of MIL-38510 qualification techniques preferred.

Please send your resume including salary history in full confidence to Mr. M. Starratt.

ITT LSI SYSTEMS SUPPORT CENTER

1351 Washington Blvd., Stamford, Connecticut 06902

An Equal Opportunity Employer, M/F

EMPLOYMENT SERVICE

"How To Get A Job Overseas" 253 pages! Jam-Packed info. + Directory 300 firms \$5 Transworld, Box 90802-HR Los Angeles 90009.

Engineers/Scientists—Over 800 firms in Eastern U.S. pay our fees to recruit Top-Caliber professionals in all technical areas. Send detailed resume, in confidence. Wallach Associates, Inc., 1010 Rockville Pike, Rockville, MD 20852.

Murkett Associates Qualified Reputable Management placement with national affiliates—fee paid. Box 527 Montgomery, AL 36101.

OVERSEAS JOB GUIDE

Job Hunting Guide + Directory of 650 Firms. Details on job sources, resumes, taxes. US \$6.50—(US & Canada). To foreign address—\$7.50. Friar Books—EL, 8956 E. Ardenale, San Gabriel, CA 91775.

TRANSLATIONS

Freelance Technical Translators needed in 30 languages. Send resume to SCITRAN, Box 5456, Sta. Barbara, CA 93108.

WHERE DO YOU FIT?

In today's job market, that is. One way to see if you're in demand is to check the employment opportunities contained in ELECTRONICS' Classified Section.

Another way to get a reading on your value is to place a blind (box number) Position Wanted ad there. The cost is low (only \$1.25 per line) and the results are often rewarding.

For more information call or write:

ELECTRONICS

Post Office Box 900
New York, N.Y. 10020
Phone: 212/997-2556

Data General Needs: Highly Specialized Senior Engineers.

If the time has come for you to put your career on a path with virtually unlimited possibilities for professional development, then your time has come for Data General. Our growth in terms of new product proliferation, revenues, facilities and manpower literally sets the pace in the small computer industry. Our salaries, benefits and advancement opportunities are established industry leaders.

The positions listed below are available in Westboro, one of our R & D centers and our Corporate Headquarters. We are surrounded by forested hillsides, with mountains to the west and north and the sea to the east. Westboro is less than an hour from the educational, religious and cultural capitol of the U.S. — Boston.

These positions exist in a creative environment where meaningful challenge and reward can be key elements in your future.

Fiber Optics Communications

This challenging position will involve thorough investigation and evaluation of fiber optics communications technology and state-of-the-art modem technology. Responsibilities will include development of fiber optics communications interfaces; development of product strategy for modems; and assessment of areas of application.

Requires BSEE minimum, with at least four years engineering experience. Prefer extensive familiarity with modems and communications systems.

Process Control

We are seeking a professional capable of functioning as lead engineer for a group designing a continuing family of analog and digital products for instrumentation interfacing. This individual will be expected to design new products while leading others in designing computer peripherals interfacing with the instrument field. Position will also involve dealings with marketing and manufacturing.

Requires BSEE minimum, with 5-7 years experience including product design, production interface and/or working with service agencies.

Intelligent Terminals

This position affords highly desirable participation in the planning and development of a new family of state-of-the-art, on-line terminals. Areas of design responsibility will include hardware, firmware and overall systems.

Requires a BSEE or BSCS with a minimum of 3 years design engineering experience. This position calls for familiarity with microcomputer architecture, MSI/LSI logic design, and microprocessor programming.

C.P.U. Logic Design

This is an opportunity to participate in the design of advanced central processors.

Requires a minimum of five years experience in design with bipolar and MOS logic families and microprocessor design.

Circuit Design

This design position will involve assisting systems engineers in selecting or generating special circuits for system use. Will involve recommendation of circuit types and families to systems engineers.

Requires BSEE plus 2-5 years circuit design experience, with knowledge of integrated circuit design and manufacturing techniques helpful.

Custom I. C. Design

This position calls for a device designer interested in participating in Data General's advanced industry position in design and manufacture of digital and special purpose analog integrated circuits. In addition to custom I. C. design, there will be significant opportunity for implementation of systems employing custom microprocessor circuits.

Requires equivalent of BSEE or BSCS with experience in computer logic/system design. Prefer experience implementing microprocessor based systems.

Data Transmission

This position will involve development of circuit techniques and transmission schemes in digital systems.

Requires BSEE with 2-5 years of design experience including knowledge of transmission line theory.

If one of these positions could be a logical next step in your career, send your resume in strict confidence to: Jim Kimbrough, Technical Personnel Representative, Data General Corp., 15 Turnpike Road, Westboro, MA 01581. Or call: (800) 225-7347, ext. 5773 outside Mass.; (617) 485-9202, ext. 5773 in Mass.

Data General

An equal opportunity employer M/F.

PRODUCT ENGINEERS

MAGNETIC MEDIA PRODUCTS DEVELOPMENT

San Francisco Peninsula

INFORMATION TERMINALS, a leader in the development of removable magnetic storage media for the computer industry is seeking several key individuals to complement our Engineering staff.

If you are degreed in EE, ME, Physics or Chemistry, have a demonstrated track record in magnetic media products development, materials and processes evaluation, magnetic recording performance characteristics or peripheral drive tape systems and are interested in joining a winning team, give us a call—we'd like to talk to you.

Exceptional benefits in a young successful, planned-growth firm. Please send resume or contact Phil Boltinghouse, INFORMATION TERMINALS, 323 Soquel Way, Sunnyvale, CA 94086. Phone (408) 245-4400. An equal opportunity employer.



Information
Terminals
Corp.

design engineers

Medical Electronics

Varian's Ultrasound Division, part of our respected Medical Group, has established its headquarters in the Salt Lake City, Utah area.

Opportunities exist at all levels for career-oriented Design Engineers with BSEE/MSEE or equivalent experience. We can offer you challenges in the design and product development of state-of-the-art medical systems. Your qualifications should include knowledge of analog, digital and video electronics, microprocessor-based technology and familiarity with acoustic components.

There's also the challenge of Utah's great outdoor activities and wide-open spaces. Room for professional growth and personal development. Room to grow at Varian, in Salt Lake City.

In addition, Varian offers competitive compensation and comprehensive benefits, including cash profit sharing and stock purchase programs. For immediate consideration, please send a resume to our Professional Staffing Office, Varian Ultrasound Division, 2341 South 2300 West, Salt Lake City, Utah 84119. We are an equal opportunity employer m/f.

We are creating
technology for the
benefit of man.

Come help us.



varian



Electronics Regional Offices Classified Section Representatives

ATLANTA 30309

Jane Core
1175 Peachtree St. NE
404/892-2868

BOSTON 02116

Holt Buchanan
607 Boylston St.
617/262-1160

CHICAGO 60611

Bill Higgins
645 N. Michigan Ave.
312/751-3733

CLEVELAND 44113

Mac Huestis
1750 Illuminating Bldg.
216/781-7000

DALLAS 75201

Mike Taylor
2001 Bryan Tower
Suite 1070
214/742-1747

DENVER 80203

Shirley Klotz
123 Speer Blvd.
Suite 400
303/837-1010

DETROIT 48202

Mac Huestis
1400 Fisher Bldg.
313/873-7410

HOUSTON 77002

Mike Taylor
375 Dresser Tower
601 Jefferson St.
713/659-8381

LOS ANGELES 90010

Stan Kassin
Ana Maria Galaz
3200 Wilshire Blvd.
South Tower
213/487-1160

NEW YORK 10020

(Sales only)
Larry Kelly
212/997-3593
Marlene Melton
212/997-2422
McGraw-Hill Bldg.
1221 Avenue of
the Americas

PHILADELPHIA 19102

Dan Ferro
Three Parkway
215/568-6161

PITTSBURGH 15222

Dean Genge
Two Gateway Center
412/391-1314

SAN FRANCISCO 94111

Mary Ellen Kenny
425 Battery St.
415/362-4600

STAMFORD 06901

Holt Buchanan
300 Broad St.
203/359-2860

McGRAW-HILL HOME OFFICE

McGraw-Hill
Publications Co.
Post Office Box 900
New York, NY 10020

MANAGER
Frank Eberle
212/997-2556

MAGAZINE SUPERVISOR FOR ELECTRONICS

Carol Allen
212/997-4392

COMMUNICATION FACILITIES

For a Xerox 400
Telecopier call 212/
997-6800 between
8:30 a.m.-4:30 p.m.
EST. For overnight
or West Coast copy,
a 24-hour unattended
3M facsimile is avail-
able. Phone 212/997-
2821, use 6 minute
speed. Also, Telex:
12-7960, and TWX:
710-581-4879.

We're not a leader in LSI. But 20 years ago, we weren't a leader in minicomputers either.

Now we're not making any dramatic predictions about our market position in 1977. But we can safely say a few things about what we're doing today in LSI.

We're using the most advanced technology available to develop custom proprietary circuits. We have a speciality expertise in the design area that allows us to design these circuits better than they've ever been done before. And we have the process technology in place to successfully manufacture some of the most complex chips in the industry.

But we can also say a great deal about our strength as a company. Average annual growth for

■ DESIGN ENGINEERING

MOS—memories, microprocessors
Bi-polar—senior level positions
Logic/systems—peripherals, LSI
Technicians—MOS or Bi-polar

■ PROCESS ENGINEERING

MOS diffusion/ion implantation
Supervisors—sustaining engineering
Technicians

■ PRODUCT & TEXT ENGINEERING

MOS product-picroprocessors
I.C. Test-senior level and supervisors
Technicians—Equipment Maintenance

us is about 40% over the last 10 years—and there are no layoffs in our background. Not a typical semiconductor company, you might say.

And you're right. But then, there's nothing typical about the way we work. Our standards are high. We don't maintain those standards by dictating artificial structures, or standing in the way of new ideas. The people we work with want an environment that lets them prove themselves, and that's what we try to give them.

So that's where we are today. You can have some impact on where we'll be tomorrow, if you can offer experience in one of these areas.

■ COMPONENT/RELIABILITY ENGINEERING

Failure analysis
Device reliability
Technicians—Failure analysis and SEM

■ SOFTWARE ENGINEERING

LSI CAD—senior level
Circuit/logic simulation
Technicians—CAD

Let's talk LSI. Contact Armand La Valle, Digital Equipment Corporation, Dept. M1208 3806A, 180 Milk Street, Westboro, Mass. 01581. We are an equal opportunity employer, m/f.



**EXPANDING THE
LIMITS OF LSI.**

digital

Engineering Opportunities at GTE Lenkurt

*Join a Company moving quickly into tomorrow
...on the San Francisco Peninsula*

GTE LENKURT is an industry leader in video, voice and data communications. For over thirty years, we have pioneered a host of developments in microwave, multiplex and data communications. Our reputation as a technological leader in our field is firmly established.

Communications is an exciting, fast-moving growing field. As we move into tomorrow, we are currently developing advanced new communications products for the telephone industry, industrial and business customers.

ENGINEERS are urgently needed for important programs in the following areas:

DEVELOPMENT

Electrical Engineers at all levels for projects and subscriber carrier, analog and digital microwave radio, and PCM carrier and switching. Experience in either linear or digital circuit design required.

APPLICATIONS

Applications and Senior Applications Engineer positions available. Must be experienced in the engineering of transmission systems, microwave, multiplex, PCM, signalling and support engineering.

MICROWAVE SYSTEMS

Responsible for defining radio performance specifications and product arrangements including baseband, IF, RF and protection switching. Must have experience in 2-13 gigahertz analog and digital radio development.

MECHANICAL

Staff Mechanical Engineer to direct and coordinate mechanical design, construction, and documentation of factory test equipment.

RELIABILITY

For analysis of electronic circuitry. Experience in circuit design and knowledge of component reliabilities is desirable.

PROJECT

Engineering of projects that integrate a wide variety of Lenkurt radio and multiplex equipment into systems that include ancillary equipment such as power plants, towers, antennas, waveguide, buildings and other appropriate equipment.

DIGITAL SYSTEMS

Responsible for defining equipment characteristics of multiline subscriber pair systems in a digital telephone office.

DESIGN SUPPORT

Electrical Engineer at various levels to maintain, modify, and assist the current production of electrical designs in various product lines.

FOR ENGINEERING POSITIONS, a BS or MSEE (or equivalent experience) is desired.

EQUIPMENT DESIGNERS

Equipment Designers must have knowledge of electromechanical packaging and/or printed circuit board layout. No degree necessary.

Our salary structure and extensive benefits package are attractive. We also provide early recognition of prior service.

- | | |
|--|--|
| <input type="checkbox"/> DEVELOPMENT | <input type="checkbox"/> RELIABILITY |
| <input type="checkbox"/> APPLICATIONS | <input type="checkbox"/> PROJECT |
| <input type="checkbox"/> MICROWAVE SYSTEMS | <input type="checkbox"/> DIGITAL SYSTEMS |
| <input type="checkbox"/> MECHANICAL | <input type="checkbox"/> DESIGN SUPPORT |
| <input type="checkbox"/> EQUIPMENT DESIGNERS | |

NAME _____
 ADDRESS _____
 CITY _____ STATE _____ ZIP _____
 TELEPHONE _____

- Resume Attached Please have Personnel Rep call me

Please send your resume, including salary history, to Professional Employment, Dept. E., GTE Lenkurt, 1105 County Road, San Carlos, CA 94070, or phone us at (415) 595-3000, Ext. 580.

**IF YOU WOULD LIKE MORE INFORMATION
ON ANY OF THE ABOVE POSITIONS,
DETACH AND MAIL THIS COUPON:**

GTE LENKURT

An equal opportunity employer

Engineers

New Growth Means New Opportunity!

NEW long term growth at Litton Systems Amecom Division means fresh career opportunities for ambitious engineers who seek professional advancement. These are IMMEDIATE career openings at all levels:

SOFTWARE SYSTEMS ENGINEERS

- * Real-time hardware controller subsystems
- * Real-time systems processing
- * Assembly, Fortran, micro-code languages

RF ENGINEERS

- * Microwave communications and receiving systems
- * High Sensitivity DF Receivers
- * Solid state microwave component design

ANALOG AND DIGITAL PROCESSING ENGINEERS

- * LSI application
- * High speed data conversion
- * Power supplies

ELECTRONIC WARFARE SYSTEMS ENGINEERS

- * State of the art ESM/ECM
- * Signal processing

TELECOMMUNICATIONS SYSTEM DESIGN ENGINEERS

- * Advanced digital subsystems including TDM
- * RF and analog subsystems including frequency synthesis and FDM techniques
- * Microprocessors and related real-time operating systems software
- * Voice switching systems

ELECTRONIC WARFARE PROCESSING - HARDWARE

- * Microwave subsystem design
- * Circuit design - RF, video, analog, high speed A/D converters
- * EW digital subsystem design - signal sorting, microprocessors/microcontroller design, computer interfacing
- * Project engineering/design supervision

All positions above require U.S. citizenship. Please send your resume and salary history in confidence to: J.J. FitzGerald.

MANUFACTURING ENGINEER

- * Proficient in assembly line techniques, line station tooling and layout
- * Solve production line and electro-mechanical problems
- * Interfacing with Design Engineering affecting timely design resolution
- * Minimum 5 years related experience, BSME preferred

DATA COORDINATOR

- * Two years as a data coordinator, BBA required
- * Responsibility for all aspects of contract data requirements including company coordination, data submittals, corrective action requirements, formal customer approvals

TEST ENGINEERS

- * BSEE with 5 years experience in design and development of FTE for RF and/or digital hardware, design and development of ATE software, preparation of test plans, procedures and specifications

PROVISIONING SPECIALIST

- * 3 years experience in preparation of illustrated parts breakdowns (IPB) in accordance with MIL-M-15071G
- * Experienced in reviewing engineering specs and drawings for preparation of provisioning lists

- * Nomenclature (DD Form 61), item descriptions (FED-STD-5) and other software to meet Federal Standards

FIELD ENGINEERS SAUDI ARABIA

- * Digital/analog experience in state of the art telecommunications systems
 - * One opening for supervisory experience engineer in installation of systems
 - * Two years or more assignment in Saudi Arabia after two months training in our College Park, MD headquarters
 - * Top salary, progressive incentive allowance, relocation, housing, 4 week's per year paid vacation, travel, tax differential
- Please send your resume and salary history in confidence to: E. Struckman



Amecom Division
**LITTON
SYSTEMS, INC.**

5115 Calvert Road
College Park
Md. 20740

Amecom is located in a residential suburb of Washington, D.C. close to all major colleges and universities and the Nation's capital. An Equal Opportunity Employer M/F/H

WHEN YOU CAN'T AFFORD

design techniques for electronics engineers

Electronics Magazine Book Series

You'll save time and money, and avoid errors, when you put this gold mine of design techniques on your desk. With almost 300 articles drawn from *Electronics Magazine's* popular feature, "Engineer's Notebook," this is an indispensable storehouse of solutions to a whole range of design problems you may encounter. You can rely on it for expert guidance at every point in the development of an engineering project—when you're making measurements . . . interpreting data . . . making calculations . . . choosing materials . . . controlling environment . . . laying out and purchasing components . . . and interconnecting components swiftly and accurately. No other reference available gives you the professional edge you get with this "must-have" sourcebook.

common-mode voltage exceeds
With a 402 op amp

ing LED versatility

of digits

likely to be confused with any other number. An alternative to the slashed zero now used is one chosen from the latter O. The symbol has full height and width, an aesthetic advantage by the common font one. The symbol for deleting four was derived from the common font by deleting segment B.

The concept also can be extended to mathematical symbols. There are 64 odd-parity seven-segment symbols, 22 of which are shown in Fig. 2. The minus symbol was chosen to be readily distinguishable from the arrow symbol and to be similar to the European arrow symbol, and also suggests the conventional notation.

The symbol for multiplication, which is peculiarly chosen, represents floating-point numbers, which is peculiarly chosen. Bases other than 10 are indicated by symbols that precede the base numbers. The symbols for 10 and 11 in base 12. The symbol for 10 also is useful for counting floating-point decimal numbers.

Complex numbers require the symbols representing

FONT	SEGMENTS USED	FONT	SEGMENTS USED
0	A B C D E F	0	A B C D E
1	B C	1	B C D
2	A B D E G	2	A B D E G
3	A B C D G	3	A B C D G
4	B C F G	4	C F G
5	A C D F G	5	A C D F G
6	A B C	6	C D E F G
7	A B C D E F G	7	A B C
8	A B C D E F G	8	A B C D E F G
9	A B C D F G	9	A B C F G

(c)

misinterpreted digits with the font presently used (b) Proposed odd-parity font when one segment fails

37

TO RE-INVENT THE WHEEL...

Here's just a sampling of the vast range of useful information you'll have at your fingertips . . .

- How to use soluble masks to protect pc boards from solder.
- How to evaluate power dissipation in microcircuit design.
- How to hand-solder DIP circuits to save testing dollars.
- How to compare the power of C-MOS with TTL.
- How to really look at low-drift IC op amps.
- How to accurately trim closed resistor loops.
- How to drive LEDs directly from C-MOS logic outputs.
- How to convert coordinates and find SWRs graphically.
- How to compare coaxial-cable shielding effectiveness.
- How to calculate resistance for sum and difference networks.
- How to use a programmable calculator to analyze filter designs.
- How to compute response of RLC networks with a short program.
- How to eliminate stray signals in remotely gain-switched op amps.
- How to chart power losses for hybrid-combined amplifiers.
- How to reduce IC FET op-amp input bias currents.
- How to build timing circuits for noisy environments.
- How to approximate waveforms with exponential functions.
- How to increase an instruction set without increasing word length.
- How to extend the life of digital recording heads.
- How to add numeric readout to logic probe displays.
- How to pick the right film for better oscilloscope pictures.
- How to use a frequency counter to measure capacitance.
- How to evaluate high-energy pulse effects on materials.
- How to operate a logic gate as a flip-flop.
- How to choose the right detector for rf power measurements.
- How to measure the access time of bipolar read-only memories.
- How to test power supplies quickly and cheaply.
- How to get the most out of a digital multimeter.
- *And much, much more.*

Order today, and don't forget the other valuable books in the Electronics Books Series listed on the coupon below.

Electronics Book Series
P. O. Box 669, Hightstown, N. J. 08520

- 1. Microprocessors**
Send me _____ copies at \$8.95 per copy.
- 2. Applying Microprocessors**
Send me _____ copies at \$9.95 per copy.
- 3. Large Scale Integration**
Send me _____ copies at \$9.95 per copy.
- 4. Basics of Data Communications**
Send me _____ copies at \$12.95 per copy.
- 5. Circuits for Electronics Engineers**
Send me _____ copies at \$15.95 per copy.
- 6. Design Techniques for Electronics Engineers**
Send me _____ copies at \$15.95 per copy.

Discounts of 40% on orders of 10 or more copies of each book.

If after my 10-day free-trial examination I am not fully satisfied, I understand that my full payment will be refunded.

- Payment enclosed Bill firm Bill me
 Charge to my credit card:
 American Express Diners Club
 BankAmericard Master Charge

Acc't No. _____ Date exp. _____

On Master Charge only, first numbers above name _____

Name _____ Title _____

Company _____

Street _____

City _____ State _____ Zip _____

SIGNATURE _____

McGraw-Hill Electronics Book Series

The Story of a Routing List Dropout

(as told in the tormented words of the victim)

inter-office memorandum

To	Ruth [REDACTED]	From	Don [REDACTED]
Company	[REDACTED] Corp.	Dept. or Pub.	Engineering
Dept. or Pub.	Library, Room C-2	Floor and Ext. or Branch	32nd fl.
Floor or Branch	42nd fl.		
Subject	Routing List		

Dear Ruth:

I'm returning the Electronics magazine routing list you sent me.

As you suggested, I contacted everyone on the list to find out who was sitting on the June 9 issue I'm looking for. You may be interested in the results:

1. I found two other people were looking for the same issue.
2. Fred K thought he had it in his briefcase, which he thought he had left in the Palo Alto office.
3. It was finally found in a pile of incoming mail in Bill Johnson's office. Bill, as you may or may not know, retired from the company three months ago.
4. With great anticipation I turned to the article on microprocessors which Mr. Snyder had referred to in a meeting. You remember Mr. Snyder. He is our President and Founder. He asked me to read the article. I turned to the article. The article wasn't there. Somebody had clipped the article out of the magazine.

Ruth, as you probably know, I am not a man to part with money lightly. But I have sent in the subscription card which by some miracle was still intact in the back of the magazine. I am going to have my very own subscription. It is going to my very own house. Therefore it is with undisguised pleasure that I ask you to

DROP ME OFF YOUR ROUTING LIST.

Don

Note to other routing list victims:

Turn to the subscription card in the back of this magazine.

Fill it out. Mail it in. We can't promise you happiness.

But you will remove one frustration from your professional life.

If you want to communicate better by radio,

To: EEV, Chelmsford, Essex, CM1 2QU, England.
Please send me details of EEV triodes and tetrodes
for radio transmission.

General information please tick.
Or information for equipment type

Name _____
Position _____
Company _____
Address _____

Telephone _____ Telex _____

S 5167/EWW

communicate with EEV.

EEV have an impressive range of triodes and tetrodes for radio transmission.

Made by one of the world's most experienced manufacturers, EEV power tubes have a vast amount of expertise behind them.

And service to match.

The range includes units with glass or ceramic envelopes and powers between 1kW and 250kW.

Whether you need tubes for replacement or are designing equipment to take them, remember that one thing is built into every one of our tubes: EEV quality.

If you'd like to know more, please fill in the coupon and send it to us at Chelmsford.

EEV TRIODES AND TETRODES	
BR1161	4CX1000A
BR1162	4CX1500B
BY1161	4CX5000A
C178	4CW10000A
C1108	4CX10000D
C1112	4CX15000A
C1134	4CW25000A
C1136	4CX35000C
CY1170J	
CY1172	

EEV/M-OV

Members of GEC - turnover £1902 million



■ ADAC	138	■ Data Precision	134	■ Gould, Inc./Instrument Systems Div./T & M	175
Admaster Corporation	182	■ Data Translation (Datation)	41	■ Grayhill, Inc.	74
* Adret Electronique	52	■ Dialight	179	Grinnell Systems	163
■ Airpax Electronics (Div. North Amer. Philips)	73	Digital Electronics Corporation	164	Gudebrod Inc.	194
■ Alco Electronic Products (Sub. of Augat)	220	■ Digital Equipment Components	58-59	Hewlett-Packard	2nd C, 1,2,21, 60,61,126,127,151,183
■ Amp, Inc.	68	Digital PDP	62-63	■ HI-G INCORPORATED	22,23
Ampex DPD	217	■ Dow Corning Resins & Chemicals	56A-56D	Honeywell TID	180
Anslay (Thomas & Betts)	161	‡ Eastman Kodak Co., Graphic Markets Division	52	Houston Instrument	166
* APEM	16E	■ E & L Instruments	160	■ Hughes Aircraft	35,162,178,181
Applied Digital Data Systems	39	‡ Electro Rent Corp.	149	Hutson Industries	152
Axiom	135	■ Electronic Applications Co.	174	Intel Memory Systems	67
■ F. W. Bell, Inc., Div. of Arnold Eng. & Allegheny Ludlum	184	■ Electronic Measurements	20	Intel-Microcomputer Components	18,19
Test Systems Div The Bendix Corp.	79	Electronic Navigation Industries	3rd C	Interface Technology	195,197
■ Bourns, Inc.	4th C	Elevam Electronic Tube Co., Ltd.	198	International Crystal Mfg. Co.	136
* Burr Brown	9E	Electronic Product Associates, Inc.	218	International Microcircuits Inc.	146
Business Week Reprints	220	EMM - Electronic Memories & Magnetics	201	Intersil	44-45
■ MGR/Bussmann Mfg. Co.	153	English Electric Valve Co.	215	■ Ithaco, Inc.	6
■ Cambridge Thermionic Corp.	177	■ Erie Technological Products	48	■ Johanson Manufacturing Corp.	70
■ Centralab/USCC	147	Essex Group Sub of United Tech	222	■ Krohn-Hite Corporation	5
* Carlo Erba SA	2E	Everett/Charles, Inc.	194	■ Lambda Electronics	185-190
■ Cherry Electrical Products	131	Fairchild (Semiconductor Operations Division)	10, 11, 171	Litronix	37
■ C & K Components	146	Faultfinders, Inc.	165	■ Magnetic Shield Division, Perfection Mica Co.	162
C. P. Clare & Company	200	‡ Ferroxcube Corp., A Div. of North Amer. Philips	54	*■ Matsuo Electric Co. Ltd.	11E
Communications '78	172	Figaro Engineering, Inc.	184	MDB Systems	200
■ Continental Rentals, Div Continental Resources	8	‡ First Computer Corporation	50,51	■ Microswitch, Div. of Honeywell	132-133
■ Continental Specialties	196	■ John Fluke Mfg. Co., Inc.	143	Mini-Circuits Laboratory	30
■ Control Data Corporation	86	Fujitsu Limited	76-77	Mitel Semiconductor, Inc.	42
Cortron Div. of Illinois Tool Works Inc.	57	‡ General Electric - Instr. Rental Div.	124	Modular Computer Systems	199
■ Custom Electronics	144	General Electric Miniature Lamp	170	Monolithic Memories	46
■ Dana Labs	145	General Instrument, Microelectronics	17	■ Motorola Semiconductor Products	43,75
Data General Corp.	129	■ GenRad	169	McCoy Electronics Co.	144

Trust Ampex to save the data you waited a year to gather.

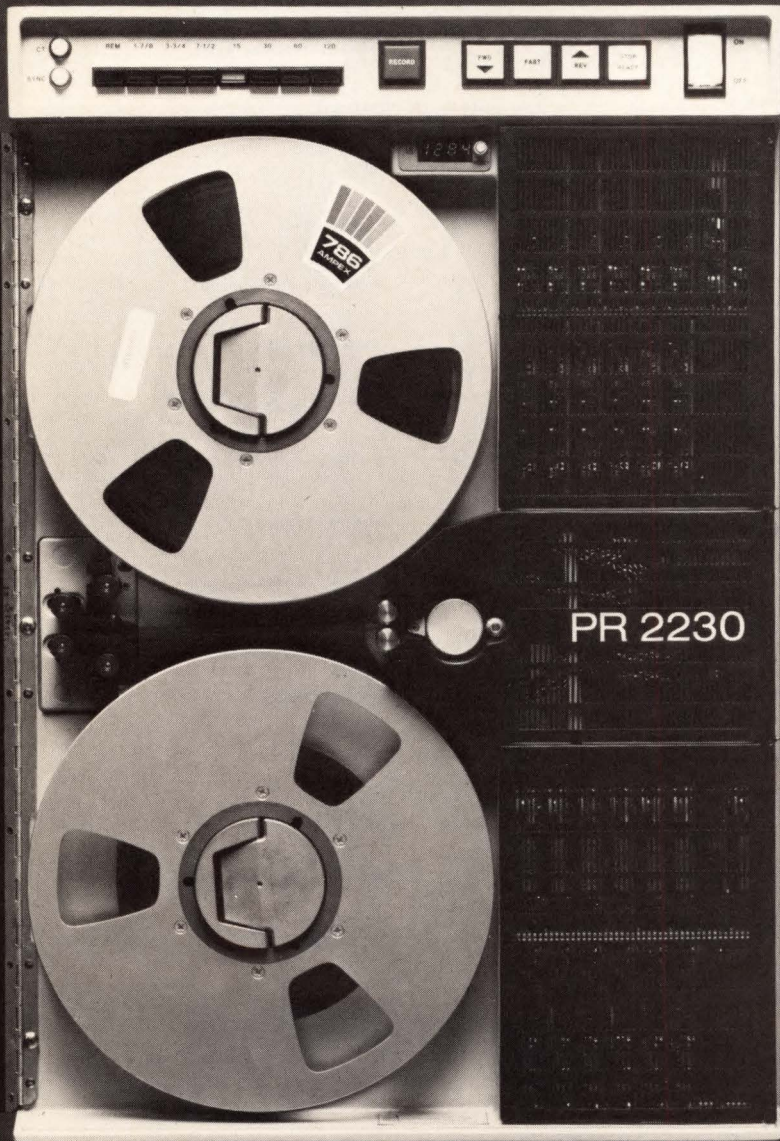

The forty by eighty foot wind tunnel at NASA's Ames Research Center in Mountain View, California. A very specialized experimental facility that's available to all bona fide researchers. But there's a long waiting list for the tunnel, and right now it's booked through the end of 1978.

That's why instrumentation data is so precious. And that's why so many experiments rely upon Ampex instrumentation recorders to save the data.

Ampex recorders, such as the PR2230, newest member of the PR2200 portable family, are ideal for on-location data recording. They record FM or direct signals. They offer seven channels or as many as 32 channels. They transport the tape slowly for maximum duration, or as fast as 120 ips for 2 MHz performance in the PR2230. They're all quiet, reliable and easy to use. And equally important, Ampex portable data recorders are built to give good service for a great many years.

NASA doesn't endorse any instrumentation recorders. That's not their job. They run this unique and beautiful facility and make it available to as many researchers as possible. And every now and then they buy another instrumentation recorder from Ampex.

Next time your plans call for multi-channel instrumentation recording, get in touch with the people who've been specializing in magnetic tape recording since the very beginning. Trust Ampex to save the data.

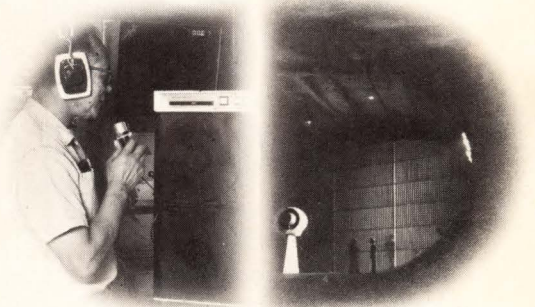

AMPEX

Ampex Corporation
Data Products Division
401 Broadway
Redwood City, California 94063
415/367-2011

Circle 217 on reader service card

MICRO68 OEM MBC

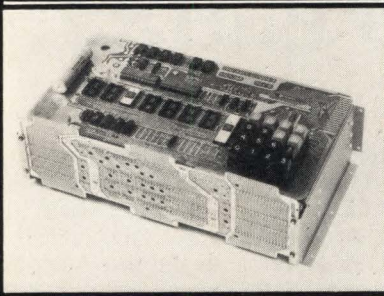

OEM MULTI BOARD CONTROLLER SYSTEM

Designed for the OEM user, the Micro-68 MBC will be the heart of your industrial control system. A complete controller, the M68 MBC comes with hex keyboard, six-digit LED display, monitor program, General Purpose board plus 4 slot mother board, and flexible mounting system. Single unit price: \$695.00.

**EPA Electronic Product
Associates, Inc.**

1157 Vega St., San Diego, CA 92110
(714) 276-8911

First in Microprocessor Systems

Circle 218 on reader service card

The 1977 Answer Book. It makes your job easier. \$25.

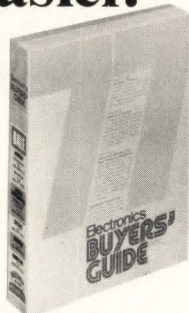

- Over 4000 products.
- More than 5000 manufacturers with local sales offices, reps/and distributors.
- Directory of Catalogs with postpaid inquiry cards for 5-second ordering of current catalogs.

Electronics Buyers' Guide
1221 Ave. of the Americas
New York, N.Y. 10020

Yes, send me a copy of The Answer Book. I've enclosed \$25 (USA and Canada only, elsewhere send \$35). Full money back guarantee if returned within 10 days.

Name _____
Company _____
Street _____
City _____ State _____ Zip _____

McGraw-Hill Book Co.	221	Stackpole Components Company	167
Nippon Electric Co., Ltd.	84,85	Statek Corp.	181
Non-Linear Systems, Inc.	178	Storage Technology Corp.	117
■ O.K. Machine & Tool Company	222	Synertek	102
Optron, Inc.	14	Systron-Donner, Concord	13
‡ Panasonic, Industrial Div.	64	TEAC Corporation	219
■ Permag Corporation	182	Technit (Technical Wire)	174
* Philips TMI	50,51	■ Tektronix	24
■ Precision Monolithics Inc.	15	Telpar	174
Process Computer Systems	87	Teradyne, Inc.	80,81
RAC - Reliability Analysis Center	198	Texas Instr., Components	140,141,158,159
‡ RCA Electro Optics & Devices	14E-15E	Thermotron Corp.	192
RCA Solid State	7,71	* Thomson CSF Division D.T.E.	7E
‡ Rohde & Schwarz	1E,5E	* Trio Kenwood Corporation	64
Rhone Poulenc - Chime Fine	176	TRW LSI Products	9
Rockwell Microelectronic Device Division	82,83	United Systems Corp., Sub. Monsanto	16
Rotron, Inc. (Commercial Prod. Div.)	142	■ Vactec, Inc.	157
■ Sanyo Electric	148	Vacuumschmelze	168
S.D.S.A.	198	‡ Vu-Data	121
* SEPA S.p.A.	121	Wavetek San Diego	88
■ Semiconductor Circuits	181	* Wavetek Indiana	124
Semtech Corporation	137	Wiltron Co.	184
* Shell International Chemical	12E		
Signetics Corporation	27,139		
* Silec Thomson	54		
Siliconix	28,29		
Singer Kearfott	156		
Solid State Scientific	123		
Sorensen, Div. of Raytheon	155		
■ Spectrol Electronics	173		
Sprague Electric	49		

Classified and employment advertising

F. J. Eberle, Manager 212-997-2557

Atomic Personnel	203
Avril, Jean-Louis	204
Battelle	204
Bell & Howell, Data Tapes Div.	203
Cal. Tube. Lab.	204
Data General	207
Digital Equipment Corp.	209
Electro Films Inc.	203
GTE Automatic Elec. Lab.	205
GTE Lenhurst	210
Harris Communication & Info. Handlings	204
ITT LSI Systems Support Center	206
Information Terminals Corp.	208
Litton Systems, Amecon Div.	211
Microtran Co.	203
Rockwell International	203
Semtech Corp.	204
Teledyne Philbrick	204
Varian	208

■ For more information of complete product line see advertisement in the latest Electronics Buyers Guide

* Advertisers in Electronics International

‡ Advertisers in Electronics domestic edition

TEAC's Done It Again Open Reel Performance in the Cassette Mode

The TEAC R-81 has all the features you look for in a high quality data recorder, but with a big plus: 4 speeds.

Open reel data recorders offer 4-speed selection as a standard feature, but cassette types have been limited to the single speed mode.

The R-81 changes all that, giving you the convenience and simplicity of a cassette recorder along with all the options of 4-speed variability. High-frequency data can be recorded at high speed and reproduced at low speed—or low-frequency data converted to a higher frequency, for analysis by a general-purpose frequency analyzer.

There are 7 channels, too, one switchable for noise compensation (fourth channel), another for memos (seventh channel).

The R-81 also features the clean, rational styling that TEAC cassette tape decks are famous for. The front-loading configuration, with all the controls on the front panel, is ideally convenient for desk-top use. It also facilitates mounting with other equipment made to professional standards, as does the body size, which meets EIA specifications.

And the R-81 is ready to operate anywhere. In addition to AC (with adapter) and DC power sources, you have the full portable versatility of dry cell battery operation.

TEAC's done it again: advanced the art of data recording. And you're the winner.



TEAC

TEAC CORPORATION, 3-7-3, Naka-cho, Musashino, Tokyo, Japan

U.S.A.: B.J. Wolfe Enterprises Inc., 10760 Burbank Blvd., North Hollywood, Calif. 91610 **England:** International Instruments Ltd., Cross Lances Rd., Hounslow, Middx. **W. Germany:** nbn Elektronik Starnberg, 813 Starnberg, Max-Emanuel-Str. 8 **France:** Tekelec Airtronic S.A., Cite des Bruyeres, Rue Carle-Vernet 92 Sevres **Holland:** SIMAC Electronics, Veenstraat 20, Veldhoven **Italy:** A.E.S.S.E. S.R.L. Corso Lodi, 47 20139 Milano **Norway:** Rodland & Reilsmo A.S., Gladengveien 3A, Oslo 6 **Sweden:** Teleinstrument ab, Maltesholmavagen 138, Vallingby **Switzerland:** Wenger Datentechnik, Bruderholzstrasse 45, 4053 Basel **Denmark:** Danbit, Plantagevej 23, 2680 Scolrod Strand **Australia:** Jacoby, Mitchell Ltd., P.O. Box 70, Kingsgrove, N.S.W. 2208

Circle 219 on reader service card

BUSINESS WEEK SPECIAL REPORT

The Next Big Leap in Electronics

Business Week brings its reputation for authority and objectivity to an analysis of the trends and applications of semi-conductors, VLSI, and other electronic developments. When will the "intelligent terminal" turn "genius"?

Business Week's Special Report, "The Next Big Leap in Electronics" is now available. Copies 1-99, \$1.75 each. Bulk prices on request.

In an industry where innovation comes in micro-seconds, Business Week is current.

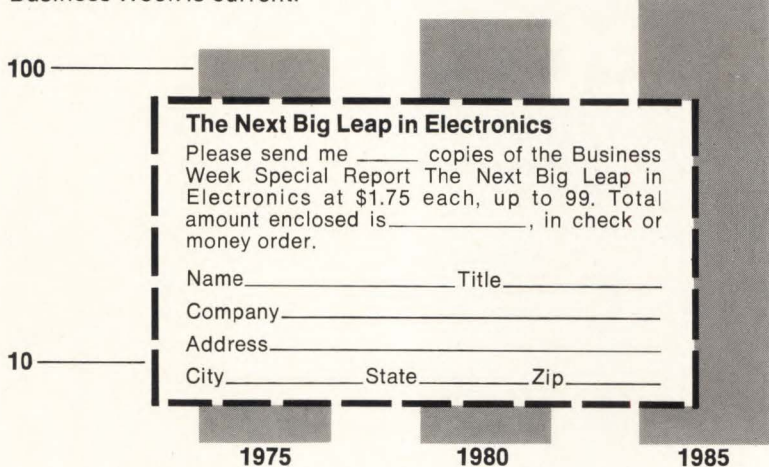

Other Business Week reprints are available for single copy and bulk sales. Please call (609) 448-1700 ext. 5550 or write Business Week Reprints, Princeton Rd., Hightstown, NJ 08520 for an inventory listing.

Advertising Sales Staff

Advertising sales manager: Paul W. Reiss
1221 Avenue of the Americas, New York, N.Y. 10020
[212] 997-4371

Atlanta, Ga. 30309: Glen N. Dougherty
100 Colony Square, 1175 Peachtree St., N.E.
[404] 892-2868

Boston, Mass. 02116: Frank Mitchell
607 Boylston St.
[617] 262-1160

Chicago, Ill. 60611
645 North Michigan Avenue
Robert W. Bartlett [312] 751-3739

Robert M. Denmead [312] 751-3738
Cleveland, Ohio 44113: William J. Boyle
[716] 586-5040

Dallas, Texas 75201: John J. Uphues
2001 Bryant Tower, Suite 1070
[214] 742-1747

Denver, Colo. 80203: Harry B. Doyle, Jr.
123 Speer Blvd. #400
[303] 837-1010

Detroit, Michigan 48202: Robert W. Bartlett
1400 Fisher Bldg.
[313] 873-7410

Houston, Texas 77002: John J. Uphues
601 Jefferson Street, Dresser Tower
[713] 659-8381

Los Angeles, Calif. 90010: Robert J. Rielly
Robert E. Boedicker, 3200 Wilshire Blvd., South Tower
[213] 487-1160

Minneapolis, Minn. 55435: Robert M. Denmead
4015 W. 65th St.
[312] 751-3738

New York, N.Y. 10020
1221 Avenue of the Americas
Michael J. Stoller [212] 997-3616

Matthew T. Reseska [212] 997-3617
Philadelphia, Pa. 19102: Matthew T. Reseska
Three Parkway
[212] 997-3617

Pittsburgh, Pa. 15222: Matthew T. Reseska
4 Gateway Center
[212] 997-3617

Rochester, N.Y. 14534: William J. Boyle
1175 Pittsford-Victor Rd., Pittsford, N.Y.
[716] 586-5040

San Francisco, Calif. 94111: Don Harris
Robert J. Rielly, 425 Battery Street,
[415] 362-4600

Paris: Patrick Mouillard
17 Rue-Georges Bizet, 75116 Paris, France
Tel: 720-73-01

United Kingdom & Scandinavia: Robert Ghey
34 Dover Street, London W1
Tel: 01-493-1451

Scandinavia: Andrew Karnig and Assoc.
Kungsholmsgatan 10
112 27 Stockholm, Sweden
Tel: 08 51 68 70 Telex: 179 51

Milan: Luigi Rancati
1 via Baracchini, Italy
Phone 86-90-656

Brussels:
23 Chaussee de Wavre
Brussels 1040, Belgium
Tel: 13-73-95

Frankfurt / Main: Fritz Krusebecker
Liebigstrasse 27c, Germany
Phone 72 01 81

Tokyo: Tatsumi Katagiri, McGraw-Hill
Publications Overseas Corporation,
Kasumigaseki Building 2-5, 3-chome,
Kasumigaseki, Chiyoda-Ku, Tokyo, Japan
[581] 9811

Business Department

Thomas M. Egan
Production Manager [212] 997-3140

Carol Gallagher
Production Manager International
[212] 997-2045

Betty Preis
Production Manager Domestic
[212] 997-2908

Roberta Cummings
Production Assistant [212] 997-2044

Frances Vallone
Reader Service Manager
[212] 997-6057

Electronics Buyers' Guide

H.T. Howland, General Manager
[212] 997-6642

Regina Hera, Directory Manager
[212] 997-2544

Roberta Cummings, Production Manager
[212] 997-2044

Frances Vallone, Reader Service Manager
[212] 997-6057

Classified and Employment Advertising

Frank Eberle, Manager
[212] 997-2557

ALCOKNOB

HIGHEST QUALITY INSTRUMENT KNOBS

Remember that knobs are the most visible part of your equipment. Therefore, field acceptance of your product depends largely upon its appearance.

ALCO has become a leading source in the USA for anodized aluminum knobs offering a wide variety of styles in five basic diameters.

Our knobs are better because they are totally machined with no compromise, even on the knurls. This offers a new dimension in appearance.

All knobs illustrated in our catalog are generally "off-the-shelf" in production quantities. However, we'll be glad to quote on custom knob designs too!

We urge you to call Customer Service at (617)-685-4371. Our salespeople know how to tend to your immediate needs. Also ask for our 36-page catalog and free sample!



ALCO ELECTRONIC PRODUCTS, INC.
501 OSGOOD STREET, NORTH ANDOVER, MA 01845, U.S.A.

Tel: (617) 685-4371

TWX: 710 342-0552

A SUBSIDIARY OF

AUGAT INC.

COSTS, CORNERS, CONFUSION.

McGraw-Hill offers you eight sure ways to cut them all...

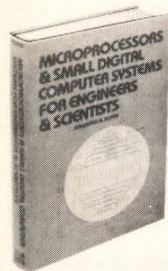

MICROPROCESSORS AND SMALL DIGITAL COMPUTER SYSTEMS FOR ENGINEERS AND SCIENTISTS

By GRANINO A. KORN. 390 pp., 104 illus.

Here's your chance to cash in on the dramatic advances in low-cost data processing power. This quick reference for end-users who need expert help in product selection, interfacing, and programming is ideal for solving data processing problems. Project managers and research supervisors will find here a handy overview of computer possibilities, system features, and costs. The guide is also indispensable for career updating and advancement.

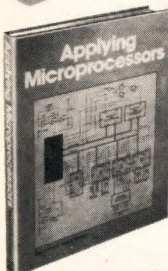

APPLYING MICROPROCESSORS New Hardware, Software, and Applications

Edited by LAURENCE ALTMAN and STEPHEN E. SCRUPSKI. 191 pp., illus., 8 1/2 x 11 format

Offering engineers and designers a wealth of new microprocessor design ideas, analyses, techniques, and practical applications, this is a much-needed follow-up volume to *Electronics* magazine's earlier book, MICROPROCESSORS. As before, this new work is a collection of recent articles from the magazine and gives you all the latest developments and advances in the rapidly expanding microprocessor field. It's fully illustrated with hundreds of photographs, charts, tables, and diagrams to clarify and highlight key points.

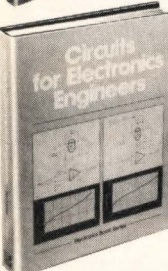

CIRCUITS FOR ELECTRONICS ENGINEERS

Edited by SAMUEL WEBER. 396 pp., illus., 8 1/2 x 11 format

Interested in clever, money-saving, solid electronic design? Here's a veritable gold mine of ideas from some of the top engineers in the world. You can consult this volume for instant help on any problem. It features 364 practical circuits that have appeared in the Designer's Casebook section of *Electronics* magazine. Because of the overwhelming public response to the Casebook, the editor selected the best and most useful design solutions and presents them here in book form.

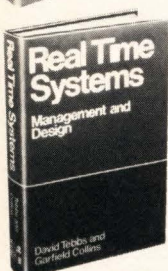

REAL TIME SYSTEMS, Management and Design

By DAVID TEBBS and GARFIELD COLLINS. 358 pp., 134 illus.

By linking the management and technical details involved in organizing Real Time (RT) systems, this book provides comprehensive guidance to everyone working in the field. The authors first examine reasons for choosing an RT system, then consider development stages, design methods and techniques, and finally in a reference section they provide information on such aspects of the RT system as application of queuing theory, details of network elements, and file structure.

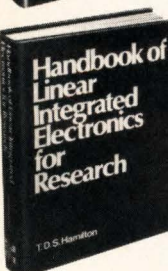

HANDBOOK OF LINEAR INTEGRATED ELECTRONICS FOR RESEARCH

By T. D. S. HAMILTON. 416 pp., illus.

With the development of low-cost integrated circuits, it is now possible for nonexperts to construct complex electronic systems. This guide is for the wide range of people who use electronics in their experimental work. The availability of particular types of integrated circuits has been taken as a unifying feature, though many discreet components are also covered.

ENGINEERING FORMULAS

By K. GIECK. 2nd Ed., 384 pp., over 1,500 formulas and more than 300 diagrams, pocket-sized 4 1/8 x 5 7/8 format

Now revised to include SI Units and updated data, this sturdily-bound, pocket-sized guide puts the engineering formulas you use most often in your work right at your fingertips. Each page is printed on one side only so you have ample space on facing pages for quick calculations or for additional formulas or notes you want to keep handy.

ENERGY TECHNOLOGY HANDBOOK

D. CONSIDINE, Editor-in-Chief. 1,859 pages, 1,111 illustrations and tables

This mammoth reference is a lavishly illustrated guide to the present state and future prospects of the energy sciences. It covers the most up-to-date technology involved in converting coal, gas, petroleum, chemical fuels, nuclear energy, solar energy, geothermal energy, and hydropower into usable and economically feasible forms of energy. Considerable attention is given to pollution control and reducing the environmental impact of some energy conversion processes.

OPTOELECTRONICS APPLICATIONS MANUAL

Prepared by The Applications Engineering Staff of the Hewlett-Packard Optoelectronics Division. 274 pp., illus.

A leading firm brings you developments in the dramatically expanding field of solid-state optoelectronics components and their applications. You can now take full advantage of the many LED devices available to you in your own design work, and find solutions to virtually any design situation. Such peripheral subjects as photometry/radiometry, contrast enhancement in visible displays, and reliability of components and their mechanical handling are also treated.

At bookstores or
direct from publisher
for 15 days'
free examination.



McGraw-Hill Book Company

1221 Avenue of the Americas, New York, N.Y. 10020

SEND ME the book(s) checked for 15 days on approval. At the end of that time, I will remit for the book(s) I keep, plus local tax, postage, and handling, and return the unwanted books postpaid. (SAVE MONEY! Remjt in full with this order, plus local tax, and McGraw-Hill pays all regular postage and handling costs. Return books in 15 days for full refund if not completely satisfied).

Name _____

Street _____

City _____

State _____ Zip _____

This order good only in U.S. and is subject to acceptance by McGraw-Hill.

- MICROPROCESSORS AND SMALL DIGITAL COMPUTER SYSTEMS FOR ENGINEERS AND SCIENTISTS (035367-0) \$24.50
- APPLYING MICROPROCESSORS (019160-3) \$15.00
- CIRCUITS FOR ELECTRONICS ENGINEERS (019157-3) \$19.50
- REAL TIME SYSTEMS (084482-8) \$13.95
- HANDBOOK OF LINEAR INTEGRATED ELECTRONICS FOR RESEARCH (084483-6) \$24.50
- ENGINEERING FORMULAS, 2/e (023203-2) \$9.95
- OPTOELECTRONICS APPLICATIONS MANUAL (028605-1) \$19.25
- ENERGY TECHNOLOGY HANDBOOK (012430-2) \$49.50

23-A279-4018-3

ok® wire wrapping center ok®

NEW HOBBY WRAP
MODEL BW 630



Battery
wire
wrapping
tool

COMPLETE WITH BIT
AND SLEEVE

STRIP / WRAP / UNWRAP
TOOL MODEL WSU-30

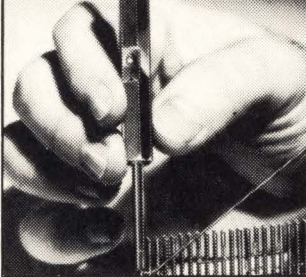

RIBBON CABLE
ASSEMBLY

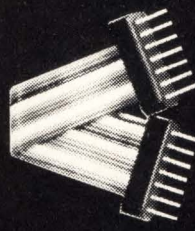

DIP SOCKETS

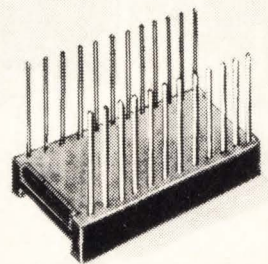

DIP IC INSERTION
TOOL WITH PIN
STRAIGHTENER

MODEL
INS-1416

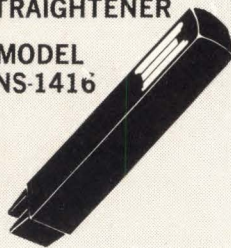

WIRE DISPENSER
MODEL
WD-30-B



PRE-CUT
PRE-STRIPPED WIRE

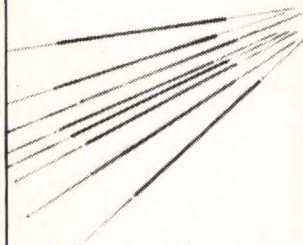

WIRE WRAPPING KIT

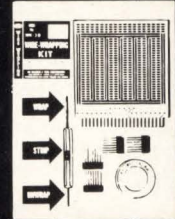

OK MACHINE AND TOOL CORPORATION

3455 CONNER STREET, BRONX, NEW YORK, N.Y. 10475 U.S.A.
PHONE (212) 994-6600 TELEX NO. 125091

Circle 222 on reader service card

CONFORMER

Just add a little heat and Essex /Stancor
Heat-Shrinkable Tubing conforms to
your every need.

Even when the heat's not on, our new line
of tubing and sleeving outperforms them
all. At Essex, we engineer for performance
and doublecheck for quality. No matter
how tough the application, we have
you covered. Essex/Stancor products
are available off-the-shelf from elec-
tronic distributors everywhere. For
more information, see your local distributor
or write us for our free catalog:

Essex/Stancor, 3501 W. Addison St.,
Chicago, IL 60618, 312/463-7400.

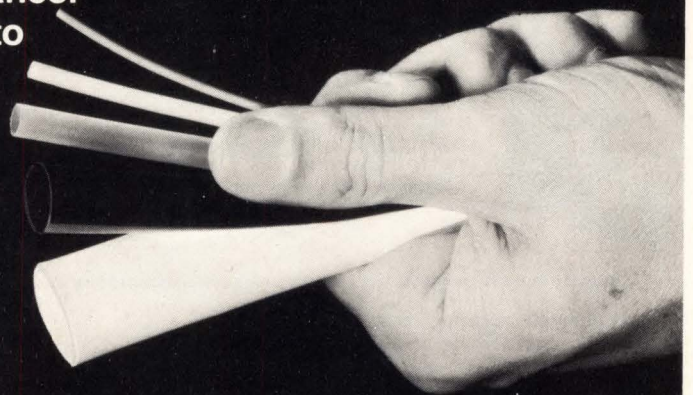

**ESSEX
GROUP**



Subsidiary of
**UNITED
TECHNOLOGIES**

Tomorrow ideas today.



Using solid-state technology to replace bulky tube-type equipment, ENI's broadband amplifiers are tomorrow ideas available today.

ENI's Class A power amplifiers already cover the frequency spectrum of 10 kHz to 1 GHz, with power outputs ranging from 300 milliwatts to over 4000 watts. And we're still climbing. Driven by any signal generator, frequency synthesizer or sweeper, ENI's compact portable amplifiers are completely broadband and untuned. Amplifying inputs of AM, FM, SSB, TV and pulse modulations with minimum distortion, these rugged units are

versatile power sources for general laboratory work, RFI/EMI testing, signal distribution, RF transmission, laser modulation, data transmission, NMR, ultrasonics and more. Designed to be unconditionally stable and failsafe (impervious to severe load conditions including open or short circuit loads), ENI power amplifiers will deliver their rated power to any load, regardless of match.

For information write: ENI, 3000 Winton Rd. So., Rochester, New York 14623. Call 716-473-6900. TELEX 97-8283 ENI ROC.

ENI

World's Leader in Solid State Power Amplifiers

Circle 901 on reader service card

Another Colorful Innovation...

Conductive Plastic Trimmers at Carbon Prices.

Just when you thought "low cost" also meant "low performance", along comes the dazzling new Bourns® Model 3355. Compare it to the CTS 201, Mepco 46X or Piher PT15. Our revolutionary conductive plastic element vs. their carbon... fact is we outperform them all. To prove it, we spec important characteristics such as CRV at 1% and a TC of 500 PPM/°C... the others don't. And only the 3355 has board-wash capability, a UL-94V-1 flammability rating and an optional choice of nine rotor colors. The standard blue is priced at just 11¢ each (100,000 pieces)... about what you'd expect to pay for the lower performance carbon types.

Send today for complete details on a colorful new way to design in superior performance for your cost effective needs — the Model 3355 Trimmer. Direct or through your local distributor.

TRIMPOT PRODUCTS DIVISION, BOURNS, INC., 1200 Columbia Ave., Riverside, CA 92507. Phone: 714 781-5050 — TWX: 910 332-1252.

CATALOG SHEET SPECIFICATION COMPARISONS

CHARACTERISTIC	BOURNS 3355	CTS 201*	MEPCO 46X*	PIHER PT15*
Element	Conductive Plastic	Carbon	Carbon	Carbon
Temperature Coefficient	500 PPM/°C	No Spec	No Spec	1000 PPM/°C
Contact Resistance Variation	1.0% max.	No Spec	No Spec	No Spec
Power Rating	.25 W at 70°C	.25 W at 55°C	.25 W at 55°C	.25 W at 40°C
Flammability	UL-94V-1	No Spec	No Spec	UL-94
Board Wash Capability	Yes	No Spec	No Spec	No Spec

* Source: CTS Series 201 Data Sheet, Mepco Data Sheet ME1004, Piher Data Sheet F-2002 Rev 7/73

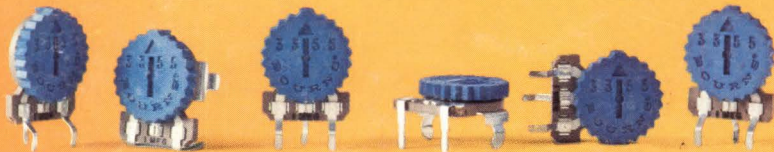

International Marketing Affiliates: European Headquarters — Switzerland 042/23 22 42 • Belgium 02/218 2005 • France 01/2039633 • Germany 0711/24 29 36 • Italy 02/32 56 88 • Netherlands 70/87 44 00 • United Kingdom 01/572 6531 • Norway 2/71 18 72 • Sweden 764/20 110 • Japan 075/921 9111 • Australia 02/55-0411 03/95-9566 • Israel 77 71 15/6/7

For Immediate Application — Circle 120
For Future Application — Circle 220